



MW Deutschland GmbH

Wiesenstraße 49, D-73614 Schorndorf

Tel.: +49 (7181) 99 92 0-0, Fax-DW: -13

E-Mail: info@de.mw.gruppocln.com

www.mwd-raeder.de

STAHLSCHEIBENRÄDER
PKW | LKW | ANHÄNGER 2023/2024



DISTRIBUTION

ITALY - MILANO-MALPENSA
MW Aftermarket

GERMANY - SCHORNDORF
MW Deutschland

FRANCE - CHAPAREILLAN
DR - Distribution Roues

POLAND - LUBLIN
MW Poland

ROMANIA - DRAGASANI
MW Romania

RUSSIA - KINGISEPP
MW Kingisepp

PRODUCTION

FRANCE - TERGNIER
MW France

ROMANIA - DRAGASANI
MW Romania

POLAND - LUBLIN
MW Lublin

RUSSIA - KINGISEPP
MW Kingisepp

TURKEY - AYDIN
JMW

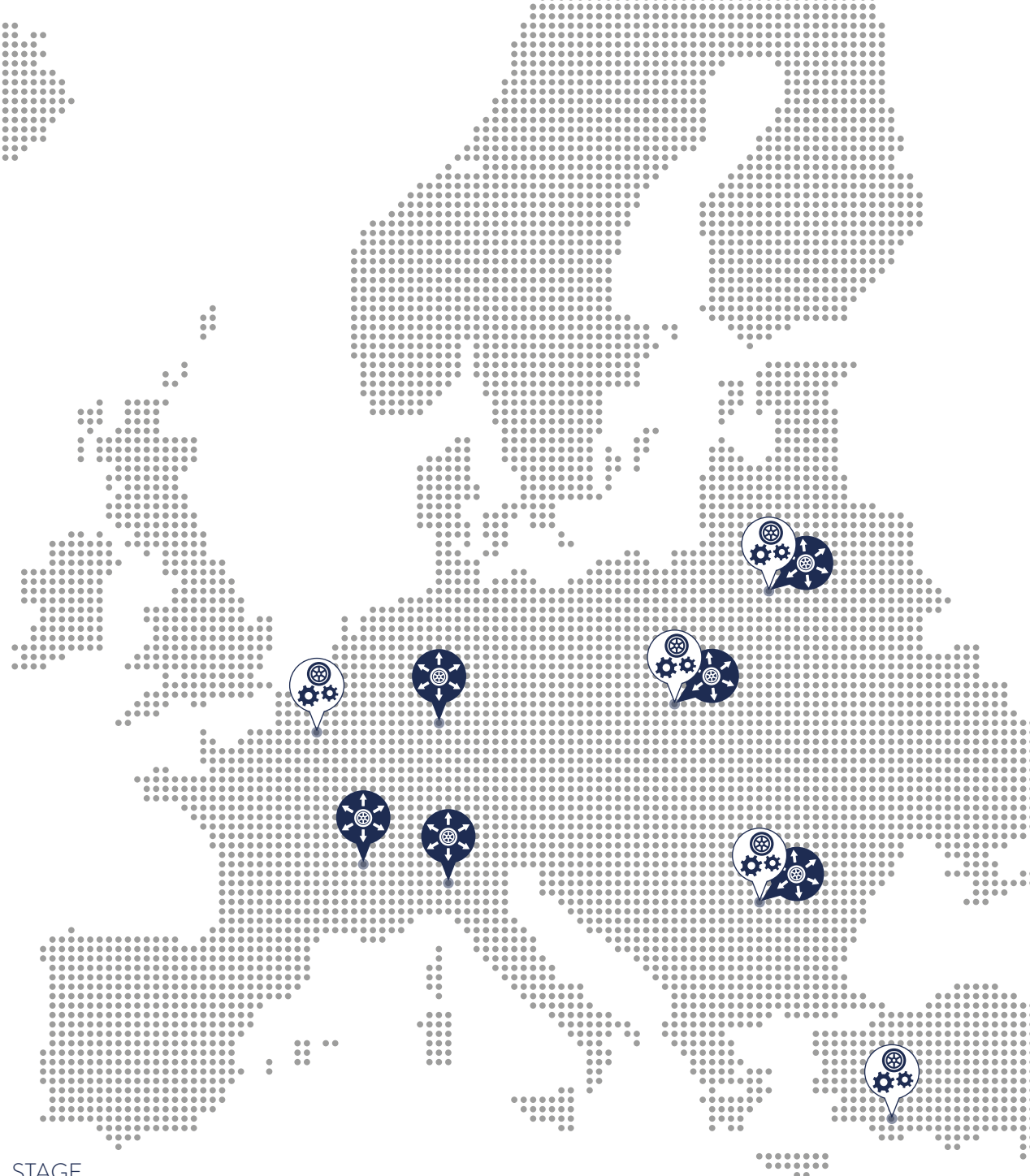

LEADING PLAYER on the GLOBAL STAGE
of FORMING and ASSEMBLY of METAL COMPONENTS
for the AUTOMOTIVE INDUSTRY

40 PLANTS | 6820 EMPLOYEES | € 1.61 BLN TURNOVER

INHALTSVERZEICHNIS

Modell	Seite
Alfa Romeo	2
Audi	3-4
BMW	5-7
Chevrolet	8
Citroën	9-13
Dacia	14
Daihatsu	15
Fiat	16-20
Ford	21-25
Honda	25
Hyundai	26-27
Iveco Nutzfahrzeuge	28
Jeep	29
Kia	30-31
Lancia	32
Land Rover	32
MAN Nutzfahrzeuge	33
Mazda	34-35
Mercedes	36-39
Mini	40
Mitsubishi	41
Nissan	42-43
Opel	44-49

Modell	Seite
Peugeot	50-55
Piaggio	55
Renault	56-59
Saab	60
Seat	61-62
Skoda	63-65
Smart	66
Streetscooter	66
Subaru	67
Suzuki	68-69
Toyota	70-72
Volkswagen	73-79
Volvo	79
Radnummern aufsteigend	80-91
PKW-Stahlscheibenräder/Trailer Räder	92-93
LKW-Stahlscheibenräder	94-98
Technische Beschreibung	99-100
Notizen	101
Allgemeine Geschäfts- und Lieferbedingungen	104

Allgemeiner Hinweis:

Wir möchten ausdrücklich darauf hinweisen, dass bei der Zuordnung der richtigen Rad-Reifenkombination immer die Angaben in der Zulassungsbescheinigung bindend ist. Je nach Fahrzeugausführung können die zulässigen Rad-Reifenkombinationen und M&S-Auflagen variieren. In unserem Räderkatalog sind immer die gängigsten Reifenabmessungen angegeben. Darüber hinaus können jedoch weitere Reifenabmessungen zulässig sein. In jedem Fall sollten Sie bei der Zuordnung immer die Grössenbezeichnung der Bereifung in der Zulassungsbescheinigung Ziffer 15.1 bis 15.2 beachten.

Wir haben uns sehr bemüht, sämtliche Daten und Zuordnungen dieses Kataloges nach bestem Wissen und Gewissen zu erstellen. Sollte sich der eine oder andere Fehler eingeschlichen haben, bitten wir um Verständnis, dass wir auf sämtliche Angaben in diesem Katalog keine Gewähr geben können.

Preisgültigkeit bis 31.12.2023

Legende

- N** Neue Räder im Programm
- A** Auslauf

Modell- bezeichnung	Motorvarianten	Bemerkungen	ABE-Nummer	Fahrzeugtyp	Bauzeit von/bis	Radab- messung	Reifengröße		MWD- Nr.	MW-AM Nr.	EAN-Nr.	Alcar- Nr.	KPZ- Nr.	Bemerk.	Anschlussmaße				Stk. p.Pal.	Preis in € exkl. MwSt.
Car model	Motorversion	General remarks	ABE-Number	Project Code	Production year	Wheel Size	Tyre Size		MWD- Ref.	MW-AM Ref.	EAN-Nr.	Alcar- Ref.	KPZ- Ref.	Remarks	Techn. Connection				Qty. p.Pal.	Price in € without TVA
															Center hole	Pitch circle diameter	Hole number	Offset in mm		

Alfa Romeo



147	1.6TS-ECO/1.6TS-16V/1.9JTDM-8V/1.9JTDM-16V		e3*98/14*0070*	937	01.01-05.10	6 J x 15	185/65R15			15124	R1-1402	4250906814027	8745	AR515010	58	98	5	37,5	40	107,10
159/159 Sport Wagon	1.8MPI-16V/1.9JTS-16V/1.9JTDM-8V/1.9JTDM-16V/2.2JTS-16V		e3*2001/116*0212*	939	09.05-04.08	7 J x 16	205/55R16	215/55R16		16079	R1-1594	4250906815949	8217	AR516003	65	110	5	34	30	107,80
159/159 Sport Wagon	1.8MPI-16V/1.9JTDM-8V/1.9JTDM-16V/2.2JTS-16V		e3*2001/116*0212*	939	05.08-12.12	7 J x 16	205/55R16	215/55R16		16079	R1-1594	4250906815949	8217	AR516003	65	110	5	34	30	107,80
Giulietta/Turismo	1.4TB-16V/1.4TB-16V-MultiAir/1.6JTDM-16V/2.0JTD-DM-16V		e3*2007/46*0027*	940	05.10-	7 J x 16	195/55R16	205/55R16		16151	R1-1772	4250906817721	8227	AR516007	65	110	5	41	30	119,60
MiTo/Turismo	0.9-8V-TwinAir/1.3JTDM-16V/1.4-8V/1.4-16V/1.4TB-16V/1.4TB-16V-MultiAir/1.6JTDM-16V	nur für 51 und 88 kW	e3*2001/116*0278*	955	09.08-12.18	6 J x 15	185/65R15			15159	R1-1475	4250906814751	8185	FL515009	58	98	4	40	48	99,00
MiTo/Turismo	0.9-8V-TwinAir/1.3JTDM-16V/1.4-8V/1.4-16V/1.4TB-16V/1.4TB-16V-MultiAir/1.6JTDM-16V		e3*2001/116*0278*	955	09.08-12.18	7 J x 16	195/55R16			16119	R1-1710	4250906817103	9442	AR516005	58	98	4	39	30	116,90



80 Cabrio/Coupé	1.8/1.9TDI/2.0/2.0i-20V/2.2/2.3/2.3i-20V/2.6/2.8/Quattro	E251/1, E251/1, E399, E399/1, e1*92/53*0002*, E1*98/14*0002*	89/89Q	03.90-05.00	6J x15	185/65R15	195/65R15	205/60R15	15019	R1-931	4250906809313	9110	AD515005	57	108	4	37	40	111,60
80	1.6/1.9TD/1.9TDI/2.0/2.0E/2.3E/2.6E/2.8E/Quattro	F889, F889/1	B4	09.91-09.94	6J x15	185/65R15	195/65R15	205/60R15	15019	R1-931	4250906809313	9110	AD515005	57	108	4	37	40	111,60
100/200	2.0/2.0E/2.3E/2.4D/2.4TD/2.5TDI/2.6E/2.8E/Quattro	F619, F619/1	C4	12.90-06.94	6J x15	195/65R15	205/60R15		15079	R1-1014	4250906810142	8860	AD515008	57	112	5	45	40	97,20
A1/Sportback	1.0TFSI/1.2TFSI/1.4TFSI/1.6TDI/2.0TDI	e1*2007/46*0414*	8X	08.10-12.18	6J x15	185/60R15			15227	R1-1760	4250906817608	7415	AD515015	57	100	5	29	40	93,30
A1 Sportback	25TFSI/30TFSI/35TFSI	e1*2007/46*1892*	6B	11.18-	5 1/2 J x15	185/65R15			15299	R1-2019	4250906820196	4055	VO515032	57	100	5	40	48	83,30
A3	1.6/1.8/1.8T/1.9TDI/Quattro	e1*95/54*0042*, e1*98/14*0042*	8L	09.96-04.03	6J x15	185/65R15	195/65R15	205/60R15	15051	R1-1229	4250906812290	8380	VO515011	57	100	5	38	40	85,90
A3/Cabrio/Sportback	1.2TFSI/1.4TFSI/1.6/1.6FSI/1.6TDI/1.8TFSI/1.9TDI/1.9TDI-e/2.0TDI/2.0FSI/2.0TFSI/Quattro/Cabrio 1.2TFSI/1.6TDI/1.8TFSI/1.9TDI/2.0TFSI/2.0TDI	e1*2001/116*0217*, -/241*, -/456*	8P	05.03-03.13	6J x16	205/55R16			16044	R1-1492	4250906814928	9535	AD516012	57	112	5	50	30	95,60
A3/Cabrio/Sportback	1.2TFSI/1.4TFSI/1.6/1.6FSI/1.6TDI/1.8TFSI/1.9TDI/1.9TDI-e/2.0TDI/2.0FSI/2.0TFSI/Quattro/Cabrio 1.2TFSI/1.6TDI/1.8TFSI/1.9TDI/2.0TFSI/2.0TDI	e1*2001/116*0217*, -/241*, -/456*	8P	05.03-03.13	6 1/2 J x16	205/55R16			16043	R1-1491	4250906814911	9915	VO516015	57	112	5	50	30	94,80
A3/Sportback	1.0TFSI/1.2TFSI/1.4TFSI/1.5TFSI/1.6TDI/1.8TFSI/1.8TFSI-g-tron/2.0TDI/2.0TSI/Quattro	e1*2007/46*0607*	8V	06.12-03.20	6J x16	205/55R16			16177	R1-1851	4250906818513	8247	VO516034	57	112	5	48	30	95,10
A3/Sportback	1.0TFSI/1.2TFSI/1.4TFSI/1.5TFSI/1.6TDI/1.8TFSI/1.8TFSI-g-tron/2.0TDI/40-etron/Quattro	e1*2007/46*0607*	8V	06.12-03.20	6 1/2 J x16	205/55R16			16178	R1-1852	4250906818520	8667	VO516035	57	112	5	46	30	95,40
A3/Sportback	1.0TFSI/1.2TFSI/1.4TFSI/1.6TDI/1.8TFSI/2.0TDI/Quattro	e1*2007/46*0607*	8V	06.12-03.20	7J x16	205/55R16			16195	R1-1872	4250906818728			57	112	5	40	30	97,40
A3 Limousine/Cabrio	1.0TFSI/1.4TFSI/1.5TFSI/1.6TDI/1.8TFSI/2.0TDI/2.0TFSI/Quattro / Cabrio 1.4TFSI/1.5TFSI/1.6TDI/1.8TFSI/2.0TDI/2.0TFSI/Quattro	ab e1*2007/46*0607*09	8V	08.13-	6 1/2 J x16	205/55R16			16194	R1-1871	4250906818711	9187	AD516016	57	112	5	43	30	105,90
A3/A3 Sportback	30g-tron/30TFSI/30TDI/35TDI/35TFSI/40TDI Quattro	e1*2007/46*2060*, e1*2007/46*2144*	GY	04.20-	6 1/2 J x16	205/55R16			16194	R1-1871	4250906818711	9187	AD516016	57	112	5	43	30	105,90
A4/Avant	1.6/1.8/1.8T/1.9TDI/2.4/2.5TDI/2.6/2.8/2.8-30V/Quattro	e1*93/81*0013*, e1*98/14*0013*	B5	12.94-11.00	6J x15	185/65R15	195/65R15	205/60R15	15079	R1-1014	4250906810142	8860	AD515008	57	112	5	45	40	97,20
A4/Avant	1.8TFSI/2.0TDI/2.0TDI-e/Quattro	bis e1*2001/116*0430*38, bis e13*2007/46*1084*16	B8/B81	11.07-12.15	7J x16	205/60R16			16107	R1-1702	4250906817028	9537	AD516014	66,5	112	5	39	30	99,90

Modell- bezeichnung	Motorvarianten	Bemerkungen	ABE-Nummer	Fahrzeugtyp	Bauzeit von/bis	Radab- messung	Reifengröße		MWD- Nr.	MW-AM Nr.	EAN-Nr.	Alcar- Nr.	KPZ- Nr.	Bemerk.	Anschlussmaße				Stk. p.Pal.	Preis in € exkl. MwSt.
Car model	Motorversion	General remarks	ABE-Number	Project Code	Production year	Wheel Size	Tyre Size		MWD- Ref.	MW-AM Ref.	EAN-Nr.	Alcar- Ref.	KPZ- Ref.	Remarks	Techn. Connection		Qty. p.Pal.	Price in € without TVA		
															Center hole	Pitch circle diameter	Hole number	Offset in mm		

Audi (Fortsetzung)

A4/Avant	1.8TFSI/2.0TDI/2.0TDI-e/2.0TFSI/2.7TDI/3.0TDI/3.2FSI/ Quattro		bis e1*2001/116*0430*38, bis e13*2007/46*1084*16	B8/B81	11.07-12.15	7 1/2 J x 16	225/55R16			16196	R1-1800	4250906818001	9707		66,5	112	5	45	30	116,90
A6/Avant	1.8/1.9TDI/2.0/2.5TDI/2.6/2.8/2.8-30V/Quattro		F619, F619/1	C4	06.94-04.97	6 J x 15	195/65R15	205/60R15		15079	R1-1014	4250906810142	8860	AD515008	57	112	5	45	40	97,20
A6/Avant	1.8/1.8T/1.9TDI/2.4/2.5TDI/2.8/Quattro		e1*96/27*0051*, e1*98/14*0051*	4B	05.97-08.99	6 J x 15	195/65R15	205/60R15		15079	R1-1014	4250906810142	8860	AD515008	57	112	5	45	40	97,20
A6/Avant	1.8/1.8T/1.9TDI/2.4/2.5TDI/2.8/Quattro		e1*96/27*0051*, e1*98/14*0051*, e1*2001/116*0051*	4B	09.99-03.05	6 J x 16	205/55R16			16005	R1-1361	4250906813617	9490	AD516004	57	112	5	40	40	118,70
A6/Avant	1.8TFSI/2.0TDI/2.8FSI/3.0TDI	einige Ausführungen nur 17 oder 18" zulässig	e1*2007/46*0436*, e13*2007/46*1147*	4G/4G1	03.11-	7 1/2 J x 16	225/60R16			16173	R1-1849	4250906818490	9873		66,5	112	5	37	30	108,60
Q2	1.0TFSI/1.4TFSI/1.6TDI/2.0TFSI/2.0TDI/30TDI/ 30TFSI/35TDI/35TFSI/Quattro		e1*2007/46*1552*	GA	11.16-	6 J x 16	205/60R16			16236	R1-1979	4250906819794	6665	V0516039	57	112	5	43	30	97,90
Q3 II/Sportback/ e-tron	35TFSI/35TFSI-Hybrid/35TDI/40TDI/45TFSI/TFSI-e/ Quattro		e1*2007/46*1900*	F3	12.18-	6 1/2 J x 17	215/65R17			17021	R1-1981	4250906819817	9021	V0517007	57	112	5	38	25	110,90
Q4 e-tron/Q4 e-tron Sportback	e-tron 35 (125kW) / 40 (150kW) / 50 (220kW)		e1*2018/858*00006*	FZ	07.21-	8 J x 19	235/55R19	255/50R19		19004	R1-2109	4250906821094	9393		57	112	5	45	16	154,10



15017 15055 16104 16105 16158 16198 16199 16211 17007

1-er (E87)	116i/116d/118i/118d/120i/120d		e1*2001/116*0287*	187	09.04-08.09	6 1/2 J x 16	195/55R16					16104	R1-1703	4250906817035	9153	BM516018	72,5	120	5	42	40	118,80
1-er (E87)	116i/116d/118i/118d/120i/120d		e1*2001/116*0287*	187	11.07-08.09	7 J x 16	205/55R16					16105	R1-1704	4250906817042	9577	BM516019	72,5	120	5	44	40	113,40
1-er Coupé/Cabrio (E82/88)	Coupé 118d/120d/125i Cabrio 118i/118d/120i		e1*2001/116*0352*	182	08.07-08.09	6 1/2 J x 16	195/55R16					16104	R1-1703	4250906817035	9153	BM516018	72,5	120	5	42	40	118,80
1-er Coupé/Cabrio (E82/88)	Coupé 120d Cabrio 118i/118d/120i/120d/125i		e1*2001/116*0352*	182	08.07-08.09	7 J x 16	205/55R16					16105	R1-1704	4250906817042	9577	BM516019	72,5	120	5	44	40	113,40
1-er (E87)	116i/116d/118i/118d/120i/120d/123d		bis e1*2007/46*0273*04, bis -/283*03	1K2/1K4	09.09-09.11	6 1/2 J x 16	195/55R16					16104	R1-1703	4250906817035	9153	BM516018	72,5	120	5	42	40	118,80
1-er (E87)	116i/116d/118i/118d/120i/120d/123d		bis e1*2007/46*0273*04, bis -/283*03	1K2/1K4	09.09-09.11	7 J x 16	205/55R16					16105	R1-1704	4250906817042	9577	BM516019	72,5	120	5	44	40	113,40
1-er (F20/21)	114i/114d/116i/116d/118i/118d/120d		e1*2007/46*0273*05, -/283*04	1K2/1K4	10.11-08.19	6 1/2 J x 16	195/55R16					16158	R1-1816	4250906818162	9243	BM516021	72,5	120	5	33	40	88,20
1-er (F20/21)	114i/114d/116i/116d/118i/118d/120d	ersetzt 16158 wegen RDKS	ab e1*2007/46*0273*05, ab -/283*04	1K2/1K4	10.11-08.19	6 1/2 J x 16	195/55R16					16199	R1-1904	4250906819046	9244	BM516025	72,5	120	5	33	40	112,60
1-er (F20/21)	114i/114d/116i/116d/116ed/118i/118d/120d/125i/125d/118d-xDrive/120d-xDrive	ersetzt 16159 wegen RDKS	ab e1*2007/46*0273*05, ab -/283*04	1K2/1K4	10.11-08.19	7 J x 16	205/55R16					16198	R1-1906	4250906819060	9613	BM516026	72,5	120	5	40	30	113,20
1-er Coupé/Cabrio (E82/88)	Coupé 118d/120i/120d/125i Cabrio 118i/118d/120i		e1*2007/46*0277*	1C	09.09-12.13	6 1/2 J x 16	195/55R16					16104	R1-1703	4250906817035	9153	BM516018	72,5	120	5	42	40	118,80
1-er Coupé/Cabrio (E82/88)	Coupé 118d/120i/120d/125i Cabrio 118i/118d/120i/120d/125i		e1*2007/46*0277*	1C	09.09-12.13	7 J x 16	205/55R16					16105	R1-1704	4250906817042	9577	BM516019	72,5	120	5	44	40	113,40
1-er (F40)	116d/116i/118d/118i		e1*2007/46*2018*	F1H	09.19-	7 J x 16	195/60R16	205/55R16				16211	R1-1916	4250906819169	7502	BM516029	66,5	112	5	47	30	110,50
1-er Coupé/Cabrio (E82/88)	Coupé 118d/120i/120d/125i Cabrio 118i/118d/120i		e1*2007/46*0277*	1C	09.09-12.13	6 1/2 J x 16	195/55R16					16104	R1-1703	4250906817035	9153	BM516018	72,5	120	5	42	40	118,80
1-er Coupé/Cabrio (E82/88)	Coupé 118d/120i/120d/125i Cabrio 118i/118d/120i/120d/125i		e1*2007/46*0277*	1C	09.09-12.13	7 J x 16	205/55R16					16105	R1-1704	4250906817042	9577	BM516019	72,5	120	5	44	40	113,40
2-er Active Tourer (F45)	214d/216d/216i/218d/218dx/218i/220i/220d/220dx		ab e1*2007/46*0371*13, bis e1*2007/46*1675*03	UKL-L/F2AT	09.14-03.18	7 J x 16	195/65R16					16211	R1-1916	4250906819169	7502	BM516029	66,5	112	5	47	30	110,50
2-er Coupé/Cabrio (F22/F23)	218d/220d/220d xDrive/220i/225d		ab e1*2007/46*0277*08	1C	01.14-	7 J x 16	205/55R16					16198	R1-1906	4250906819060	9613	BM516026	72,5	120	5	40	30	113,20
3-er Compact (E36/5)	316i/318iS/318ti/318tds		e1*93/81*0017*, e1*98/14*0017*	3/CG	05.94-05.01	6 J x 15	185/65R15					15017	R1-953	4250906809535	8885	BM515005	72,5	120	5	42	40	102,50
3-er Compact (E36/5)	316i/318iS/318ti/318tds/323ti		e1*93/81*0017*, e1*98/14*0017*	3/CG	05.94-05.01	7 J x 16	205/55R16	225/50R16				16029	R1-1490	4250906814904	9690	BM516003	72,5	120	5	47	30	123,40

Modell- bezeichnung	Motorvarianten	Bemerkungen	ABE-Nummer	Fahrzeugtyp	Bauzeit von/bis	Radab- messung	Reifengröße			MWD- Nr.	MW-AM Nr.	EAN-Nr.	Alcar- Nr.	KPZ- Nr.	Bemerk.	Anschlussmaße				Stk. p.Pal.	Preis in € exkl. MwSt.	
Car model	Motorversion	General remarks	ABE-Number	Project Code	Production year	Wheel Size	Tyre Size			MWD- Ref.	MW-AM Ref.	EAN-Nr.	Alcar- Ref.	KPZ- Ref.	Remarks	Techn. Connection				Qty. p.Pal.	Price in € without TVA	
															Center hole	Pitch circle diameter	Hole number	Offset in mm				

BMW (Fortsetzung)

3-er (E36)	316i/318i/318iS/318tds/320i/323i/325i/325td/ 325tds/328i		F547, e1*93/81*0015*, e1*96/79*0084*	3-C/3-CNG	12.90-04.98	6 J x15	185/65R15			15017	R1-953	4250906809535	8885	BM515005		72,5	120	5	42	40	102,50
3-er (E36)	316i/318i/318iS/318tds/320i/323i/325td/325tds/328i		e1*93/81*0015*	3/C	08.95-04.98	7 J x16	205/55R16	225/50R16		16029	R1-1490	4250906814904	9690	BM516003		72,5	120	5	47	30	123,40
3-er Touring (E36)	316i/318i/318tds		e1*93/81*0015*	3/C	05.95-09.99	6 J x15	185/65R15			15017	R1-953	4250906809535	8885	BM515005		72,5	120	5	42	40	102,50
3-er Touring (E36)	316i/318i/318tds/320d/320i/323i/325tds/328i		e1*93/81*0015*	3/C	08.95-09.99	7 J x16	205/55R16	225/50R16		16029	R1-1490	4250906814904	9690	BM516003		72,5	120	5	47	30	123,40
3-er Coupé/Cabrio (E36)	Coupé 316i/318iS/320i/323i/325i/328i/Cabrio 318i/320i/323i/325i		F920, e1*93/81*0016*	3B/3-B	01.92-04.00	6 J x15	185/65R15			15017	R1-953	4250906809535	8885	BM515005		72,5	120	5	42	40	102,50
3-er Coupé/Cabrio (E36)	Coupé 316i/318iS/320i/323i/325i/328i/Cabrio 318i/320i/323i/325i/328i		e1*93/81*0016*	3/B	04.98-04.00	7 J x16	205/55R16	225/50R16		16029	R1-1490	4250906814904	9690	BM516003		72,5	120	5	47	30	123,40
3-er Compact (E46)	316ti/318ti/318td		e1*98/14*0167*, e1*2001/116*0167*	346K	06.01-03.05	6 1/2 J x15	195/65R15	205/60R15		15055	R1-1319	4250906813198	9400	BM515012		72,5	120	5	42	40	111,10
3-er Compact (E46)	316ti/318ti/318td/320td/325ti		e1*98/14*0167*, e1*2001/116*0167*	346K	06.01-03.05	7 J x16	205/55R16	225/50R16		16029	R1-1490	4250906814904	9690	BM516003		72,5	120	5	47	30	123,40
3-er Compact (E46)	316ti/318ti/318td/320td/325ti		e1*98/14*0167*, e1*2001/116*0167*	346K	06.01-03.05	7 J x17	205/50R17			17001	R1-1409	4250906814096	9960	BM517002		72,5	120	5	47	20	147,20
3-er Lim/Touring (E46)	316i/318i/318d/320i/320d/323i/Touring 316i/318i/318d/320i/320d		e1*97/27*0097*, e1*98/14*0097*	346L	04.98-09.05	6 1/2 J x15	195/65R15	205/60R15		15055	R1-1319	4250906813198	9400	BM515012		72,5	120	5	42	40	111,10
3-er Lim/Touring (E46)	316i/318i/318d/320i/320d/323i/325i/328i/Touring 316i/ 318i/318d/320i/320d/323i/328i		e1*97/27*0097*, e1*98/14*0097*	346L	04.98-09.05	7 J x16	205/55R16	225/50R16		16029	R1-1490	4250906814904	9690	BM516003		72,5	120	5	47	30	123,40
3-er Lim/Touring (E46)	316i/318i/318d/320i/320d/323i/325i/328i/330i/330d/ Touring 316i/318i/318d/320i/320d/323i/325i/328i/3 30i/330d		e1*98/14*0097*	346L	04.00-09.05	7 J x17	205/50R17			17001	R1-1409	4250906814096	9960	BM517002		72,5	120	5	47	20	147,20
3-er 4x4 (E46)	325xi		e1*98/14*0144*, e1*2001/116*0144*	346X	04.00-03.05	7 J x16	205/55R16			16029	R1-1490	4250906814904	9690	BM516003		72,5	120	5	47	30	123,40
3-er Lim/ Touring/4x4 (E46)	325xi/330xi/330xd/Touring 330xi/330xd		e1*98/14*0144*, e1*2001/116*0144*	346X	04.00-09.05	7 J x17	205/50R17			17001	R1-1409	4250906814096	9960	BM517002		72,5	120	5	47	20	147,20
3-er Coupé/Cabrio (E46)	316Ci/318Ci/320Ci/323Ci Cabrio 318Ci		e1*98/14*0112*, e1*2001/116*0112*, e1*98/14*0146*, e1*2001/116*0146*	346C/346R	10.99-03.07	6 1/2 J x15	195/65R15	205/60R15		15055	R1-1319	4250906813198	9400	BM515012		72,5	120	5	42	40	111,10
3-er Coupé/Cabrio (E46)	Coupé 316Ci/318Ci/320Ci/323Ci/325Ci/328Ci Cabrio 318Ci/320Ci/323Ci/325Ci		e1*98/14*0112*, e1*2001/116*0112*, e1*98/14*0146*, e1*2001/116*0146*	346C/346R	10.99-03.07	7 J x16	205/55R16	225/50R16		16029	R1-1490	4250906814904	9690	BM516003		72,5	120	5	47	30	123,40
3-er Coupé/Cabrio (E46)	Coupé 316Ci/318Ci/320Ci/323Ci/325Ci/328Ci/ 330Ci/330Cd Cabrio 318Ci/320Ci/323Ci/325Ci/330Ci		e1*98/14*0112*, e1*2001/116*0112*, e1*98/14*0146*, e1*2001/116*0146*	346C/346R	04.00-03.07	7 J x17	205/50R17			17001	R1-1409	4250906814096	9960	BM517002		72,5	120	5	47	20	147,20
3-er (E90)	316i/318i/318d/320i/320d/325i		e1*2001/116*0308*	390L	03.05-08.07	7 J x16	205/55R16	225/50R16		16078	R1-1598	4250906815987	8345	BM516017		72,5	120	5	34	40	127,50
3-er (E90)	316i/318i/318d/320i/320d/325i		ab e1*2001/116*0308*09	390L	09.07-12.09	7 J x16	205/55R16			16106	R1-1705	4250906817059	9557	BM516020		72,5	120	5	31	24	121,60
3-er Coupé/Cabrio (E92/93)	Coupé 316Ci/320Ci/320Cd/325Ci Cabrio 320Ci/320Cd/ 325Ci		e1*2001/116*0346*	392C	01.06-08.07	7 J x16	205/55R16	225/50R16		16078	R1-1598	4250906815987	8345	BM516017		72,5	120	5	34	40	127,50

3-er Coupé/Cabrio (E92/93)	Coupé 316Ci/320Ci/320Cd/325Ci Cabrio 320Ci/320Cd/325Ci	e1*2001/116*0346*	392C	09.07-12.09	7 J x16	205/55R16			16106	R1-1705	4250906817059	9557	BM516020	72,5	120	5	31	24	121,60
3-er Touring (E91)	318i/318d/320i/320d/325i	e1*2001/116*0308*	390L	09.05-08.07	7 J x16	205/55R16	225/50R16		16078	R1-1598	4250906815987	8345	BM516017	72,5	120	5	34	40	127,50
3-er Touring (E91)	318i/318d/320i/320d/325i	ab e1*2001/116*0308*09	390L	09.07-12.09	7 J x16	205/55R16			16106	R1-1705	4250906817059	9557	BM516020	72,5	120	5	31	24	121,60
3-er xDrive (E90)	320d/325iX	e1*2001/116*0344*	390X	07.05-06.08	7 J x16	205/55R16	225/50R16		16078	R1-1598	4250906815987	8345	BM516017	72,5	120	5	34	40	127,50
3-er xDrive (E90)	320d	ab e1*2001/116*0344*06	390X	07.08-12.09	7 J x16	205/55R16			16106	R1-1705	4250906817059	9557	BM516020	72,5	120	5	31	24	121,60
3-er Lim/Touring (E90/91)	316d/318i/318d/320i/320d/320d-xDrive/325i	bis e1*2007/46*0314*04, -/315*05, bis e24*2007/46*0022*02	3L/3K/3K-N1	01.10-01.12	7 J x16	205/55R16			16106	R1-1705	4250906817059	9557	BM516020	72,5	120	5	31	24	121,60
3-er Coupé/Cabrio (E93)	Coupé 316i/318i/320i/320d/320d-xDrive/325i Cabrio 318i/320i/320i/320d/325i	bis e1*2007/46*0316*07	3C	01.10-01.14	7 J x16	205/55R16			16106	R1-1705	4250906817059	9557	BM516020	72,5	120	5	31	24	121,60
5-er (E60)	520i/520d/523i/525i	e1*2001/116*0230*	560L	08.03-02.10	7 J x16	205/60R16	225/55R16		16065	R1-1568	4250906815680	9970	BM516013	72,5	120	5	20	40	126,80
5-er Touring (E61)	520d/523i	e1*2001/116*0230*	560L	01.06-04.10	7 J x16	225/55R16			16065	R1-1568	4250906815680	9970	BM516013	72,5	120	5	20	40	126,80
X1 (E84)	16d/16i/18d/18i/20d/20i/23d/25i/28i/x-Drive/s-Drive	e1*2007/46*0275*, -/454*, e24*2007/46*0024*	X1/X1-N1/X-N1	11.09-09.15	7 1/2 J x17	225/50R17			17007	R1-1759	4250906817592	9863	BM517005	72,5	120	5	34	25	138,50
Z3 Roadster (E36/7)	1.8i/1.9i	e1*93/81*0029*	R/C	03.96-03.03	6 J x15	185/65R15			15017	R1-953	4250906809535	8885	BM515005	72,5	120	5	42	40	102,50
Z3 Roadster/Coupe (E36/7/8)	1.9i/2.0i/2.2i/2.8i/3.0i	e1*93/81*0029*, e1*98/14*0029*	R/C	07.98-03.03	7 J x16	225/50R16			16029	R1-1490	4250906814904	9690	BM516003	72,5	120	5	47	30	123,40

Modell- bezeichnung	Motorvarianten	Bemerkungen	ABE-Nummer	Fahrzeugtyp	Bauzeit von/bis	Radab- messung	Reifengröße			MWD- Nr.	MW-AM Nr.	EAN-Nr.	Alcar- Nr.	KPZ- Nr.	Bemerk.	Anschlussmaße				Stk. p.Pal.	Preis in € exkl. MwSt.		
Car model	Motorversion	General remarks	ABE-Number	Project Code	Production year	Wheel Size	Tyre Size			MWD- Ref.	MW-AM Ref.	EAN-Nr.	Alcar- Ref.	KPZ- Ref.	Remarks	Techn. Connection				Qty. p.Pal.	Price in € without TVA		
																Center hole	Pitch circle diameter	Hole number	Offset in mm				

Chevrolet



Aveo	1.2LS/1.4LT		e4*2007/46*0270*	KL1T	07.11-12.14	5 1/2 J x 14	185/75R14			14194	R1-1860	4250906818605				56,5	100	4	39	54	86,70
Aveo	1.2/1.2-Bifuel/1.4	4-loch	e4*2007/46*0270*, e50*2007/46*0087*	KL1T/CHIV	07.11-12.14	6 J x 15	195/65R15	205/60R15		15250	R1-1843	4250906818438	8613	CV515001		56,5	100	4	39	40	90,70
Aveo	1.3TD/1.6	5-loch	e4*2007/46*0270*	KL1T	07.11-12.14	6 J x 15	195/65R15	205/60R15		15251	R1-1846	4250906818469	7710	CV515002		56,5	105	5	39	40	83,00
Captiva	2.0D-LS/LT/2.4LS/LT/3.0LT/3.2LT/2WD/4WD		e4*2001/116*0113*	KLAC	06.06-12.14	6 1/2 J x 16	215/70R16			16150	R1-1792	4250906817929	7895	OP516011		70,3	115	5	46	30	150,90
Cruze	1.5/1.6/1.6LS/1.8LS/LT		e4*2001/116*0140*, e50*2007/46*0007*	KL1J/CHIR	05.09-12.14	6 1/2 J x 16	205/60R16	215/60R16		16143	R1-1776	4250906817769	9247	OP516013		56,5	105	5	39	30	103,00
Cruze	1.7D-L/2.0D-LS/LT		e4*2001/116*0140*	KL1J	05.09-12.14	6 1/2 J x 16	205/60R16	215/60R16		16144	R1-1777	4250906817776	9327	OP516014		70,3	115	5	41	30	103,90
Epica	2.0i-V6/2.0D-LS/LT/2.5i-V6/LS/LT		e4*2001/116*0068*06	KLAL	07.06-12.10	6 J x 15	205/65R15			15157	R1-1514	4250906815147	7970	DJ515004		56,5	114,3	4	49	40	112,30
Evanda	2.0CDX		bis e4*2001/116*0068*05	KLAL	04.03-06.06	6 J x 15	205/65R15			15157	R1-1514	4250906815147	7970	DJ515004		56,5	114,3	4	49	40	112,30
Orlando	1.8/2.0D		e4*2007/46*0224*, e50*2007/46*0050*	KL1Y/CHIO	03.11-12.14	6 1/2 J x 16	215/60R16			16144	R1-1777	4250906817776	9327	OP516014		70,3	115	5	41	30	103,90
Spark	1.0/LS/1.2LS/LT		e4*2007/46*0129*, e50*2007/46*0006*	KL1M/CHIS	03.10-12.14	4 1/2 J x 14	155/70R14	165/65R14		14192	R1-1831	4250906818315	4925	CV514001		56,5	100	4	43,5	56	97,40
Trax	1.4T-MT/1.6T-MT/1.7TD-MT/AWD	.	e4*2007/46*0696*	KL1B	05.13-12.14	6 1/2 J x 16	195/70R16	205/70R16	215/65R16	16181	R1-1866	4250906818667	9272	OP516015		56,6	105	5	38	30	104,20
Volt	1.4 Hybrid	.	e13*2007/46*1158*	D1JC1	06.12-12.14	6 1/2 J x 16	205/60R16			16144	R1-1777	4250906817776	9327	OP516014		70,3	115	5	41	30	103,90

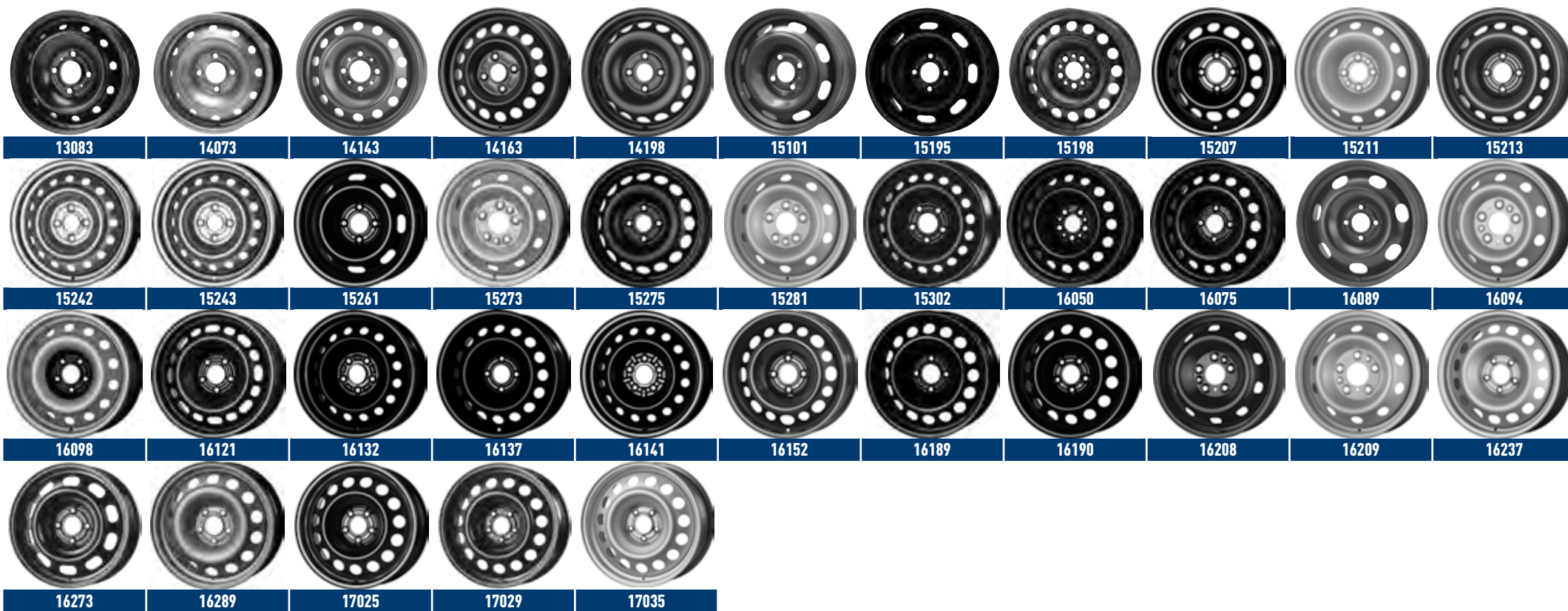

Berlingo I	Multispace 1.1iX/1.2iX/1.4iX/1.8i/1.9DX/SX/2.0HDI	e2*93/81*0057*, -/58*, -/59*, -/132*, -/181*, e2*98/14*0057*, -/58*, -/132*, -/181*, -/201*, -/224*, -/225*, -/226*, -/227*	M*KFX/DJY/HDZ/WJ/LFX/RHY/HFX/KFW/NFU/WJY	01.97-03.03	5 1/2 J x 14	175/65R14	175/70R14		14073	R1-1278	4250906812788	6395	PS614002	65	108	4	24	54	86,30
Berlingo I	Multispace 1.4i/1.6HDI/1.9D/2.0HDI	e2*2001/116*0275*, -/277*, -/278*, -/321*, -/338*	G*KFW/WJY/RHY/9HX/9HW	04.03-06.08	5 1/2 J x 14	175/70R14			14073	R1-1278	4250906812788	6395	PS614002	65	108	4	24	54	86,30
Berlingo II	1.6HDI/1.6-16V/Electrique	e2*2001/116*0366*, e2*2007/46*0002*	7/7/*****	07.08-12.18	6 1/2 J x 15	195/65R15	195/70R15	205/65R15	15213	R1-1735	4250906817356	8477	PS615003	65	108	4	27	40	97,60
Berlingo II	1.6HDI/1.6-16V	e2*2001/116*0366*, e2*2007/46*0002*	7/7/*****	07.08-12.18	6 1/2 J x 16	215/55R16			16089	R1-1663	4250906816632	7860	PS516012	65	108	4	26	30	105,90
Berlingo III M	1.2-PureTech 110/1.5HDI-75/100	e2*2007/46*0624*	E	09.18-	6 1/2 J x 15	195/65R15			15302	R1-2056	4250906820561	5477	PS615004	65	108	5	42	40	102,60
Berlingo III M/XL	1.2-PureTech 110/1.5HDI-75/100/130	Radlast 610 kg	e2*2007/46*0624*	E	09.18-	6 1/2 J x 16	205/60R16	215/65R16	16190	R1-1887	4250906818872	7460	PS616004	65	108	5	47	30	108,30
e-Berlingo III	e-Berlingo Elektro (100kW)	Radlast 700 kg	e2*2007/46*0624*13	E	09.21-	6 1/2 J x 16	205/60R16	215/65R16	16289	R1-2094	4250906820943	7461	PS616004	65	108	5	47	30	108,30
e-C4 X	Elektroantrieb (57kW)				02.23-	6 1/2 J x 18	195/60R18		18007					N	65	108	4	26	
C-Zero	Elektroantrieb (49kW)	nur für Vorderachse	e2*2007/46*0068*	1	01.11-	4 J x 15	145/65R15		15242	R1-1805	4250906818056	7160	PS515049	56	100	4	35	48	115,70

Modell- bezeichnung	Motorvarianten	Bemerkungen	ABE-Nummer	Fahrzeugtyp	Bauzeit von/bis	Radab- messung	Reifengröße		MWD- Nr.	MW-AM Nr.	EAN-Nr.	Alcar- Nr.	KPZ- Nr.	Bemerk.	Anschlussmaße				Stk. p.Pal.	Preis in € exkl. MwSt.
Car model	Motorversion	General remarks	ABE-Number	Project Code	Production year	Wheel Size	Tyre Size		MWD- Ref.	MW-AM Ref.	EAN-Nr.	Alcar- Ref.	KPZ- Ref.	Remarks	Techn. Connection				Qty. p.Pal.	Price in € without TVA
															Center hole	Pitch circle diameter	Hole number	Offset in mm		

Citroën (Fortsetzung)

C-Zero	Elektroantrieb (49kW)	nur für Hinterachse	e2*2007/46*0068*	1	01.11-	5 J x 15	175/55R15			15243	R1-1806	4250906818063	7235	PS515050		54	100	4	35	48	115,00
C1	1.0i-VVT/1.4HDI		bis e11*2001/116*0238*10	P/P*****	06.05-05.14	4 1/2 J x 14	155/65R14			14163	R1-1601	4250906816014	4940	TO514017		54	100	4	39	63	83,10
C1 II	VTi68/VTi82		ab e11*2001/116*0238*11, e6*2007/46*0349*	P*****	06.14-	4 1/2 J x 14	165/65R14			14198	R1-1930	4250906819305	5770	TO514021		54	100	4	35	63	80,30
C1 II	VTi68/VTi82		ab e11*2001/116*0238*11, e6*2007/46*0349*	P*****	06.14-	4 1/2 J x 15	165/60R15			15275	R1-1931	4250906819312	7510	TO515019		54	100	4	35	56	95,70
C2	1.1i/1.4i/1.4HDI		e2*2001/116*0283*, -/284*, -/286*, -/316*, -/344*	J*HFX/KFV/KFU/8HX/8HZ	11.03-12.10	5 1/2 J x 14	165/70R14	175/65R14		14143	R1-1150	4250906811507	6215	PS514022		65	108	4	24	54	83,80
C2	1.1i/1.4i/1.4HDI/1.6i-16V		ab e2*2001/116*0283*06, -/284*, -/285*, -/286*, -/316*, -/344*	J*8HX/KFV/NFU/8HZ/KFU/HFX	11.03-12.10	6 J x 15	185/55R15			15101	R1-1372	4250906813723	8690	PS515037		65	108	4	27	40	91,30
C3	1.1i/1.4i/1.4i-16V/1.4HDI/1.4-Bivalent		e2*98/14*0256*, -/257*, -/259*, e2*2001/116*0289*, -/317*	F*HFX/KFV/8HX/8HZ/KFU	04.02-11.09	5 1/2 J x 14	165/70R14	175/65R14		14143	R1-1150	4250906811507	6215	PS514022		65	108	4	24	54	83,80
C3/C3 X-TR	1.4i/1.4i-16V/1.4HDI/1.4-Bivalent/1.6i-16V/1.6HDI		ab e2*98/14*0256*, -/257*, -/258*, -/259*, -/261*, e2*2001/116*0289*, -/317*, -/318*, -/329*	F*KFV/NFU/8HX/8HY/KFU/8HZ/9HX/9HZ/HFX	04.02-11.09	6 J x 15	185/60R15			15101	R1-1372	4250906813723	8690	PS515037		65	108	4	27	40	91,30
C3 Pluriel	1.4i/1.4HDI/1.6i-16V		e2*2001/116*0266*	H/H*****	06.03-12.10	6 J x 15	185/65R15			15101	R1-1372	4250906813723	8690	PS515037		65	108	4	27	40	91,30
C3 II	1.1i/1.4HDI/1.4VTi/1.6HDI/1.6VTi		e2*2007/46*0003*	S/S*****	12.09-12.16	6 J x 15	185/65R15			15195	R1-1651	4250906816519	8055	PS515045		65	108	4	23	40	87,10
C3 III	1.2-Puretech-68/82/110 / 1.6-BlueHDI-75/100		ab e2*2007/46*0003*44	S	01.17-	6 J x 15	185/65R15	195/65R15		15195	R1-1651	4250906816519	8055	PS515045		65	108	4	23	40	87,10
C3 III	1.2-Puretech-68/82/110 / 1.6-BlueHDI-75/100		ab e2*2007/46*0003*44	S	01.17-	6 1/2 J x 15	185/65R15	195/65R15		15261	R1-1889	4250906818896	7385	PS515052		65	108	4	20	40	93,70
C3 III	1.2-Puretech-68/82/110 / 1.6-BlueHDI-75/100		ab e2*2007/46*0003*44	S	01.17-	6 1/2 J x 16	205/55R16			16189	R1-1890	4250906818902	9432	PS516021		65	108	4	20	30	97,90
C3 III	1.2-Puretech-68/82/110 / 1.6-BlueHDI-75/100	Stylingrad	ab e2*2007/46*0003*44	S	01.17-	6 1/2 J x 16	205/55R16			16278	R1-2020	4250906820202				65	108	4	23	30	99,90
C3 Aircross	1.2/1.6HDI		e4*2007/46*1241*	2	10.17-	6 1/2 J x 15	195/65R15			15261	R1-1889	4250906818896	7385	PS515052		65	108	4	20	40	93,70
C3 Aircross	1.2/1.6HDI		e4*2007/46*1241*	2	10.17-	6 1/2 J x 16	195/60R16	205/60R16		16189	R1-1890	4250906818902	9432	PS516021		65	108	4	20	30	97,90
C3 Aircross	1.2/1.6HDI	Stylingrad	e4*2007/46*1241*	2	10.17-	6 1/2 J x 16	195/60R16	205/60R16		16278	R1-2020	4250906820202				65	108	4	23	30	99,90
C3 Picasso	1.2-THP110/1.4-VTi-95/1.6-HDi-90/100		e2*2001/116*0371*, e24*2007/46*0029*	SH/SH*****/SH8FN	10.08-09.17	6 J x 15	195/60R15			15195	R1-1651	4250906816519	8055	PS515045		65	108	4	23	40	87,10
C3					09.23-	6 1/2 J x 16				16300				N	65	108	4	20	30		
C4/C4-Coupé	1.4i-16V/1.6i-16V/1.6HDI/2.0i-16V/Coupé 1.4i-16V/1.6i-16V/1.6HDI		e2*2001/116*0302*	L/L*****	11.04-10.10	6 J x 15	195/65R15			15101	R1-1372	4250906813723	8690	PS515037		65	108	4	27	40	91,30
C4/C4-Coupé	1.4i-16V/1.6i-16V/1.6HDI/2.0i-16V/2.0HDI		e2*2001/116*0302*	L/L*****	11.04-10.10	6 1/2 J x 16	205/55R16	215/55R16		16075	R1-1589	4250906815895	8565	PS516011		65	108	4	26	30	106,70

Modellbezeichnung	Motorvarianten	Bemerkungen	ABE-Nummer	Fahrzeugtyp	Bauzeit von/bis	Radabmessung	Reifengröße			MWD-Nr.	MW-AM Nr.	EAN-Nr.	Alcar-Nr.	KPZ-Nr.	Bemerk.	Anschlussmaße				Stk. p.Pal.	Preis in € exkl. MwSt.		
Car model	Motorversion	General remarks	ABE-Number	Project Code	Production year	Wheel Size	Tyre Size			MWD-Ref.	MW-AM Ref.	EAN-Nr.	Alcar-Ref.	KPZ-Ref.	Remarks	Techn. Connection				Qty. p.Pal.	Price in € without TVA		
																Center hole	Pitch diameter	Hole diameter	Offset in mm				

Citroën (Fortsetzung)

DS4	PureTech 130/180/225/Hybrid180		ab e2*2007/46*0628*10	F	02.21-	7 J x17	215/65R17			17025	R1-1996	4250906819961	9036	PS517006		65	108	5	42	25	115,90
DS7 Crossback	Pure Tech 225 / Blue HDI 130/180		e2*2007/46*0601*	J	02.18-	7 J x17	195/55R17			17029	R1-2040	4250906820400				65,1	108	5	44	25	116,40
Jumpy II Kombi (Facelift)	2.0i/2.0HDI		e2*2001/116*0187*	B/B*****	01.04-01.07	6 1/2 J x15	205/65R15			15198	R1-1643	4250906816434	9385			58	98	5	31	40	105,40
Jumpy III Kombi	HDI-90/HDI-120/HDI-135/Hdi-160/2.0i-16V/L1/L2		e2*2001/116*0350*, e2*2007/46*0045*	X/X*****	02.07-05.16	7 J x16	215/60R16			16098	R1-1675	4250906816755	7780	PS616001		65	108	5	42	30	118,40
Jumpy IV Spacetourer/e-Spacetourer	1.6-HDi95/HDi115/2.0-HDi150/HDi180/Electro(100kW)		e2*2007/46*0530*	V	06.16-	7 J x16	215/65R16			16237	R1-1980	4250906819800	7505	PS616003		65	108	5	46	30	105,40
Jumpy IV Spacetourer/e-Spacetourer	1.6-HDi95/HDi115/2.0-HDi150/HDi180/Electro(100kW)		e2*2007/46*0530*	V	06.16-	7 J x17	215/60R17	225/55R17		17035	R1-2046	4250906820462	9026			65	108	5	46	25	136,20
Jumper I Kombi	1.9TD/2.0/2.5D/2.5TD/2.8HDI/4x4		6712/6713,6714,6831,e3*96/27*0027*	Z3/230/230L/230D/230P	03.94-03.02	6 J x15	195/70R15	205/70R15	215/70R15	15281	R1-1941	4250906819411	4012	FL615007		71,1	118	5	68	40	108,90
Jumper I Kombi (Facelift)	2.0HDI29C/2.2HDI29C/33M/33MH/2.8HDI33M/33MH/4x4		e3*98/14*0104*	Z	04.02-06.06	6 J x15	195/70R15	205/70R15		15281	R1-1941	4250906819411	4012	FL615007		71,1	118	5	68	40	108,90
Jumper II Kombi	2.2HDI-100/110/120/130/150/3.0HDI-160/180		bis e3*2001/116*0234*10, bis e2*2007/46*0046*04	Y	07.06-03.14	6 J x15	205/70R15	215/70R15	225/70R15	15281	R1-1941	4250906819411	4012	FL615007		71,1	118	5	68	40	108,90
Jumper II Kombi	2.2HDI-120/130/150/3.0HDI-160/180		bis e3*2001/116*0234*10, bis e2*2007/46*0046*06	Y	07.06-03.14	6 J x16	215/75R16	225/75R16		16209	R1-1910	4250906819107	7011	FL616009		78,1	130	5	68	30	133,90
Jumper III Kombi	2.2HDI120/140		ab e3*2001/116*0234*12, e2*2007/46*0736*	Y	04.14-	6 J x15	215/70R15	225/70R15		15281	R1-1941	4250906819411	4012	FL615007		71,1	118	5	68	40	108,90
Jumper III Kombi	2.2HDI120/140		ab e3*2001/116*0234*12	Y	04.14-	6 J x16	225/75R16			16208	R1-1909	4250906819091	6011	FL616008		71,1	118	5	68	25	141,60
Nemo Kombi	1.3HDI-75/1.4i/1.4HDI		e3*2001/116*0273*, e3*2007/46*0013*	A	03.08-12.15	6 J x15	185/65R15			15211	R1-1681	4250906816816	7680	FL515013		58	98	4	44	40	100,30
Xsara	1.4i/1.4D/1.6i/1.8i-16V/1.9D/2.0i/2.0HDI/Coupé 1.4i/1.6i-16V/2.0i-16V/2.0HDI		e2*98/14*0115*, -/128*, -/189*, -/232*, -/233*, -/234*, -/236*, -/108*, -/109*, -/110*, e2*2001/116*0268*	N6/N*/RHY/MJY/KFW/NFU/RFN/RHZ/LFY/RV/RFS/8HZ	10.00-10.04	6 J x15	195/55R15			15180	R1-1087	4250906810876	8470	PS515022		65	108	4	18	40	102,70
ZX/ZX Break	1.4i-X/1.9DX/Tonic		F834, e2*93/81*0074*, -/75*, -/82*	N2/N2L2	03.91-04.98	5,00B x13	165/70R13			13083	R1-1300	4250906813006	4075	5527A		65	108	4	28	63	74,80

Citroën Nfz.

Berlingo I	600 1.1i/1.4i/1.8D/1.9D/2.0HDI / 800 1.4i/1.9D		H419	M4	09.96-03.03	5 1/2 J x14	165/70R14	175/65R14		14073	R1-1278	4250906812788	6395	PS614002		65	108	4	24	54	86,30
Berlingo I	600 Niveau 1.1i/1.4i/1.9D / 800 Niveau 1.4i/1.9D/2.0HDI		L080, L159, L161	M59/M59GN/M59GL	04.03-06.08	5 1/2 J x14	175/65R14			14073	R1-1278	4250906812788	6395	PS614002		65	108	4	24	54	86,30
Berlingo II	1.6HDI/1.6-16V		N129	B9	07.08-12.18	6 1/2 J x15	195/65R15	195/70R15		15213	R1-1735	4250906817356	8477	PS615003		65	108	4	27	40	97,60
Berlingo III M	1.2-PureTech 110/1.5HDI-100/1.6HDI-75/100		e2*2007/46*0625*	E	09.18-	6 1/2 J x15	195/65R15			15302	R1-2056	4250906820561	5477	PS615004		65	108	5	42	40	102,60

Berlingo III M/XL	1.2-PureTech 110/1.5HDI-100/130/1.6HDI-75/100	Radlast 700 kg	e2*2007/46*0625*	E	09.18-	6½J x16	205/60R16	215/65R16		16289	R1-2094	4250906820943	7461	PS616004	65	108	5	47	30	108,30
Jumpy II (Facelift)	2.0HDi		H173	U64	01.04-01.07	6½J x15	195/65R15	205/65R15		15198	R1-1643	4250906816434	9385		58	98	5	31	40	105,40
Jumpy III Kasten	HDI-90/HDI-120/HDI-135-FAP/2.0i-16V/L1H1/L2H1/L2H2		L863	G9	02.07-05.16	7 J x16	215/60R16			16098	R1-1675	4250906816755	7780	PS616001	65	108	5	42	30	118,40
Jumpy IV/e-Jumpy IV	1.6-HDi95/HDi115/2.0-HDi120/HDi150/HDi180/Elektro (100kW)		e2*2007/46*0531*	V	06.16-	7 J x16	215/65R16			16237	R1-1980	4250906819800	7505	PS616003	65	108	5	46	30	105,40
Jumpy IV/e-Jumpy IV	1.6-HDi95/HDi115/2.0-HDi120/HDi150/HDi180/Elektro (100kW)		e2*2007/46*0531*	V	06.16-	7 J x17	215/60R17			17035	R1-2046	4250906820462	9026		65	108	5	46	25	136,20
Jumper I	1.9TD/2.0/2.5D/2.5TD/2.8HDI/4x4	Radlast 1.000 kg	G712, G713, G714, G831, e3*96/27*0027	230L/230D/230P/23	03.94-03.02	6 J x15	195/70R15	205/70R15	215/70R15	15273	R1-1908	4250906819084	4011	FL615007	71,1	118	5	68	40	108,90
Jumper I	1.9TD/2.0/2.5D/2.5TD/2.8HDI/4x4	Radlast 1.000 kg	G712, G713, G714, G831, e3*96/27*0027	230L/230D/230P/23	03.94-03.02	6 J x15	195/70R15	205/70R15	215/70R15	15281	R1-1941	4250906819411	4012	FL615007	71,1	118	5	68	40	108,90
Jumper I (Facelift)	2.0HDI29C/29CH/33C/33M/2.2HDI29M/33C/33CH/33M-H/33LH/2.0iBipower/2.8HDI33M/33MH/33LH	Radlast 1.000 kg	K907, K908, K909, L114	244/244D/244L/244M	04.02-06.06	6 J x15	195/70R15	205/70R15		15273	R1-1908	4250906819084	4011	FL615007	71,1	118	5	68	40	108,90
Jumper I (Facelift)	2.0HDI29C/29CH/33C/33M/2.2HDI29M/33C/33CH/33M-H/33LH/2.0iBipower/2.8HDI33M/33MH/33LH	Radlast 1.000 kg	K907, K908, K909, L114	244/244D/244L/244M	04.02-06.06	6 J x15	195/70R15	205/70R15		15281	R1-1941	4250906819411	4012	FL615007	71,1	118	5	68	40	108,90
Jumper II	2.2HDI-100/110/120/130/150/3.0HDI-160/180	Radlast 1.000 kg	L773, L774, L939, bis e3*2007/46*0046*06	250/250D/250L/Y	07.06-06.11	6 J x15	195/70R15	205/70R15		15273	R1-1908	4250906819084	4011	FL615007	71,1	118	5	68	40	108,90
Jumper II	2.2HDI-100/110/120/130/150/3.0HDI-160/180	Radlast 1.000 kg	L773, L774, L939, bis e3*2007/46*0046*06	250/250D/250L/Y	07.06-06.11	6 J x15	195/70R15	205/70R15		15281	R1-1941	4250906819411	4012	FL615007	71,1	118	5	68	40	108,90
Jumper II	2.2HDI/3.0HDI	Radlast 1.200 kg	L773, L774, L939, bis e3*2007/46*0046*06	250/250D/250L/Y	07.06-06.11	6 J x16	215/75R16	225/75R16		16209	R1-1910	4250906819107	7011	FL616009	78,1	130	5	68	30	133,90
Jumper II (Facelift)	2.2HDI-110/130/150	Radlast 1.000 kg	bis e2*2007/46*0252*, bis e2*2007/46*0254*03	YB/YC	07.11-03.14	6 J x15	205/70R15	215/70R15	225/70R15	15273	R1-1908	4250906819084	4011	FL615007	71,1	118	5	68	40	108,90
Jumper II (Facelift)	2.2HDI-110/130/150	Radlast 1.000 kg	bis e2*2007/46*0252*, bis e2*2007/46*0254*03	YB/YC	07.11-03.14	6 J x15	205/70R15	215/70R15	225/70R15	15281	R1-1941	4250906819411	4012	FL615007	71,1	118	5	68	40	108,90
Jumper II (Facelift)	2.2HDI-130/150/180	Radlast 1.200 kg	bis e3*2007/46*0051*07, bis e2*2007/46*0256*03	Y/YD	07.11-03.14	6 J x16	215/75R16	225/75R16		16209	R1-1910	4250906819107	7011	FL616009	78,1	130	5	68	30	133,90
Jumper II	2.2HDI-120/3.0HDI-160		e2*2007/46*0256*, e3*2007/46*0046*, e3*2007/46*0051*	Y/YD	07.06-03.14	6 J x16	215/75R16	225/75R16		16094	R1-1636	4250906816366	9601	FL616004	78,1	130	5	68	30	130,00
Jumper III	HDI110/120/130/140/150/160/165/175/180	Radlast 1.000 kg	ab e3*2001/116*0234*12, ab e3*2007/46*0046*10, ab e2*2007/46*0252*03, ab e2*2007/46*0254*04	Y/YB/YC	04.14-	6 J x15	215/70R15	225/70R15		15273	R1-1908	4250906819084	4011	FL615007	71,1	118	5	68	40	108,90
Jumper III	HDI110/120/130/140/150/160/165/175/180	Radlast 1.000 kg	ab e3*2001/116*0234*12, ab e3*2007/46*0046*10, ab e2*2007/46*0252*03, ab e2*2007/46*0254*04	Y/YB/YC	04.14-	6 J x15	215/70R15	225/70R15		15281	R1-1941	4250906819411	4012	FL615007	71,1	118	5	68	40	108,90
Jumper III	HDI110/120/130/140/150/160/165/175/180	Radlast 1.100 kg	ab e3*2001/116*0234*14, ab e3*2007/46*0046*10	Y	04.14-	6 J x16	225/75R16			16208	R1-1909	4250906819091	6011	FL616008	71,1	118	5	68	25	141,60
Jumper III/e-Jumper	HDI130/150/165/175/180/Elektro (90kW)	Radlast 1.200 kg	ab e3*2001/116*0234*12, ab e2*2007/46*0256*04, ab e3*2007/46*0046*10, ab e2*2007/46*0051*08	Y/YD	04.14-	6 J x16	215/75R16	225/75R16		16209	R1-1910	4250906819107	7011	FL616009	78,1	130	5	68	30	133,90
Nemo Kastenwagen	1.3HDI-75/1.4i/1.4HDI		N130, e3*2007/46*0013*	225L/A	03.08-12.15	6 J x15	185/65R15			15211	R1-1681	4250906816816	7680	FL515013	58	98	4	44	40	100,30

Modell- bezeichnung	Motorvarianten	Bemerkungen	ABE-Nummer	Fahrzeugtyp	Bauzeit von/bis	Radab- messung	Reifengröße	MWD- Nr.	MW-AM Nr.	EAN-Nr.	Alcar- Nr.	KPZ- Nr.	Bemerk.	Anschlussmaße				Stk. p.Pal.	Preis in € exkl. MwSt.
Car model	Motorversion	General remarks	ABE-Number	Project Code	Production year	Wheel Size	Tyre Size	MWD- Ref.	MW-AM Ref.	EAN-Nr.	Alcar- Ref.	KPZ- Ref.	Remarks	Techn. Connection				Qty. p.Pal.	Price in € without TVA
														Center hole	Pitch circle diameter	Hole number	Offset in mm		

Dacia

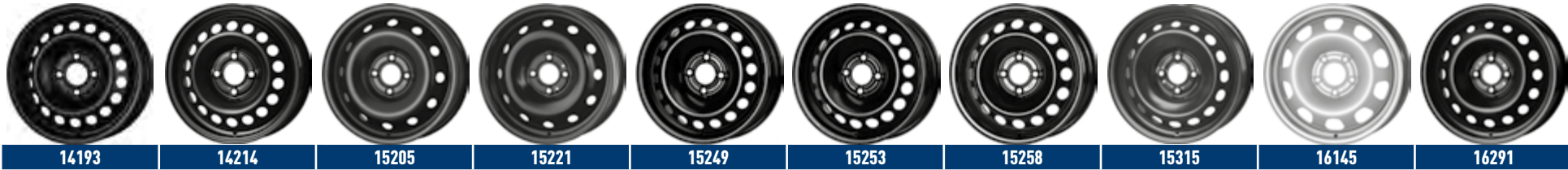

Dokker/Express/ Stepway	1.2TCe115/1.3TCe/1.6MPI/1.5dCi75/1.5dCi90	bei 84kW je nach Ausführung nur 6 J x 15 ET 50 zulässig	e1*2001/116*0314*, e2*2007/46*0030*	SD	01.13-08.21	6 J x 15	185/65R15	15249	R1-1845	4250906818452	7775	RE515029		60	100	4	40	40	91,90
Dokker/Express	1.2TCe115	je nach Ausführung nur 6 J x 15 ET 40 zulässig	e2*2007/46*0030*	SD	01.13-08.21	6 J x 15	185/65R15	15205	R1-1684	4250906816847	7635			60	100	4	50	40	95,80
Duster	1.2TCe-125/1.5dCi-85/90/110/1.6-16V- LPG/4x2/1.5dCi-100/1.6-16V/4x4		e2*2001/116*0314*, e2*2007/46*0030*, e2*2001/116*0323*	SD/SR	04.10-12.17	6 1/2 J x 16	215/65R16	16145	R1-1779	4250906817790	8873	RE516018		66	114,3	5	50	30	100,70
Duster	dCi95/dCi115/SCe115-LPG/TCe130/TCe150/2WD/ dCi115/SCe115/TCe130/TCe150/4WD		ab e2*2001/116*0323*43	SR	01.18-	6 1/2 J x 16	215/65R16	16145	R1-1779	4250906817790	8873	RE516018		66	114,3	5	50	30	100,70
Jogger	1.0TCe110/1.0TCe90ECO-G/1.6Hybrid		ab e19*2007/46*0026*16-17	DJF	03.22-	6 1/2 J x 16	205/60R16	16291	R1-2102	4250906821025	6007			60	100	4	43	30	109,60
Lodgy	1.2TCe/1.5dCi/1.6MPI		e2*2001/116*0314*, e2*2007/46*0030*	SD	04.12-	5 1/2 J x 14	185/70R14	14193	R1-1844	4250906818445				60	100	4	40	54	83,50
Lodgy/Stepway	1.2TCe/1.3TCe/1.5dCi/1.6MPI	Stepway je nach Ausführung nur 16" zulässig	e2*2001/116*0314*	SD	04.12-02.22	6 J x 15	185/65R15	15249	R1-1845	4250906818452	7775	RE515029		60	100	4	40	40	91,90
Lodgy/Stepway	TCe100/TCe130/Blue dCi115		e2*2001/116*0314*	SD	03.22-	6 J x 15	185/65R15	15315	R1-2101	4250906821018				60	100	4	40	40	99,40
Logan/MCV/ Sandero/Stepway	1.2-16V/1.4MPI/1.4MPI-LPG/1.5dCi/1.6MPI/Stepway 1.5dCi/1.6MPI/Stepway 1.ddCi/1.6MPI		bis e2*2001/116*0314*57 (*63), -/323*, bis e2*2007/46*0030*19	SD/SR	07.05-12.12	6 J x 15	185/65R15	15221	R1-1724	4250906817240				60	100	4	43	40	89,70
Logan/MCV/ Sandero/Stepway	1.2-16V/1.4MPI/1.4MPI-LPG/1.5dCi/1.6MPI		bis e2*2001/116*0314*57 (*63), -/323*, e2*2001/116*0323*, bis e2*2007/46*0030*19	SD/SR	07.05-12.12	6 J x 15	185/65R15	15205	R1-1684	4250906816847	7635			60	100	4	50	40	95,80
Logan Express/ Pick Up	1.4MPI/1.5dCi/1.6MPI		N386	FSD/USD	01.09-12.12	6 J x 15	185/65R15	15205	R1-1684	4250906816847	7635			60	100	4	50	40	95,80
Logan II/MCV II/ Sandero II	0.9-Tce90/1.0/1.2-16V/1.5D-dCi75/dCi90		ab e2*2001/116*0314*58 (*64), ab e2*2007/46*0030*20, ab e1*2001/116*0323*42	SD/SR	01.13-12.20	6 J x 15	185/65R15	15258	R1-1873	4250906818735	8932	RE515030		60	100	4	40	40	95,20
Sandero Stepway	1.5dCi/1.6MPI		ab e2*2001/116*0314*29 bis *44	SD	06.09-12.12	6 J x 15	185/65R15	15205	R1-1684	4250906816847	7635			60	100	4	50	40	95,80
Sandero (Mj.21)	SCe65/TCe90/TCe90CVT/TCO-G		e19*2007/46*0026*	DFJ	11.20-	6 J x 15	185/65R15	15253	R1-1855	4250906818551	7777	RE515027		60	100	4	40	40	94,90
Spring	Electric-Comfort/Comfort Plus (33kW)		e9*2018/858*11001*	DBG	03.21-	4 1/2 J x 14	165/70R14	14214	R1-2113	4250906821131	3515			60	100	4	37	63	84,80



15190

Charade	1.33VWT-i	e11*2001/116*0249*	XP9F(a)	06.11-01.13	5 1/2 J x 15	185/60R15	15190	R1-1607	4250906816076	7890	T0515011	54	100	4	45	48	101,80
---------	-----------	--------------------	---------	-------------	--------------	-----------	-------	---------	---------------	------	----------	----	-----	---	----	----	--------

Modell- bezeichnung	Motorvarianten	Bemerkungen	ABE-Nummer	Fahrzeugtyp	Bauzeit von/bis	Radab- messung	Reifengröße		MWD- Nr.	MW-AM Nr.	EAN-Nr.	Alcar- Nr.	KPZ- Nr.	Bemerk.	Anschlussmaße				Stk. p.Pal.	Preis in € exkl. MwSt.
Car model	Motorversion	General remarks	ABE-Number	Project Code	Production year	Wheel Size	Tyre Size		MWD- Ref.	MW-AM Ref.	EAN-Nr.	Alcar- Ref.	KPZ- Ref.	Remarks	Techn. Connection		Qty. p.Pal.	Price in € without TVA		
															Center hole	Pitch circle diameter	Hole number	Offset in mm		

Fiat

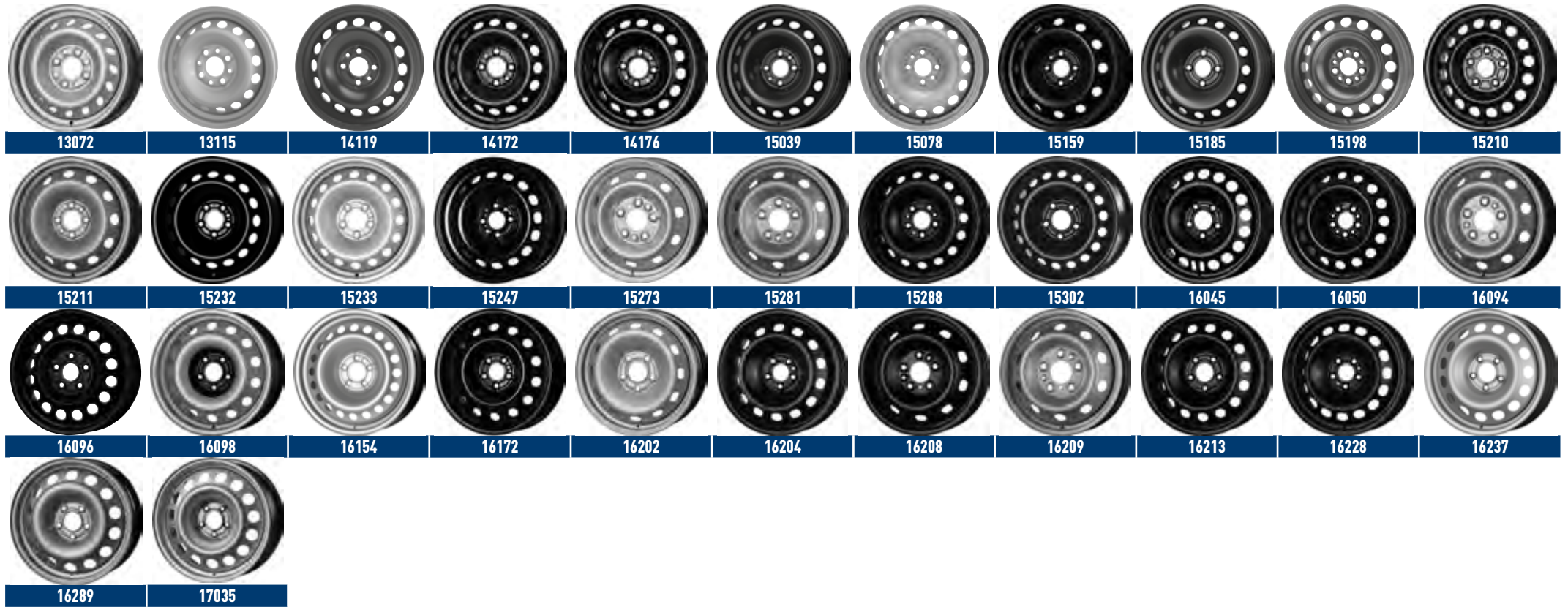

500/500C	0.9-8V/1.0-Hybrid/1.2-8V/1.3D-Multijet-16V/1.4-16V	schwarz	e3*2001/116*0261*, e3*2007/46*0064*	312	07.07-	5 1/2 J x 14	165/65R14	175/65R14		14176	R1-1689	4250906816892	6315	FL514026	58	98	4	35	54	75,60
500/500C	0.9-8V/1.0-Hybrid/1.2-8V/1.3D-Multijet-16V/1.4-16V	silber	e3*2001/116*0261*, e3*2007/46*0064*	312	07.07-	5 1/2 J x 14	165/65R14	175/65R14		14210	R1-2063	4250906820639	6315	FL514026	58	98	4	35	54	75,60
500/500C	1.4-16V		bis e3*2001/116*0261*09, e3*2007/46*0064*	312	07.07-	6 J x 15	185/55R15			15159	R1-1475	4250906814751	8185	FL515009	58	98	4	40	48	99,00
500e	Electro (70/87kW)		e3*2018/858*00001*,-/12*	FA1	11.20-	6 J x 15	185/65R15			15159	R1-1475	4250906814751	8186	FL515009	58	98	4	40	48	99,00
500L	0.9TwinAir/1.3-16V Multijet/ 1.4-16V	je nach Ausführung nur 16" zulässig	e3*2001/116*0217*	199	10.12-	6 J x 15	195/65R15			15233	R1-1743	4250906817431	8737	FL515024	58	98	5	39	40	89,30
500L/Living/ Trekking	0.9CNG/0.9TwinAir/1.3-16V Multijet/1.6D-Multijet		bis e3*2001/116*0217*67	199	10.12-	6 J x 16	195/60R16	205/55R16		16172	R1-1835	4250906818353	8053	FL516007	58	98	5	36,5	30	101,90

500L/Living/Trekking	1.3D-Multijet/1.4/1.4LPG/1.6D-Multijet		e3*2001/116*0217*	199	10.12-	6J x16	205/55R16			16204	R1-1907	4250906819077	8049	FL616007	58	98	5	36,5	30	102,90
500X	City-Look/1.3D-Multijet/1.4MultiAir/1.6E-torQ/1.6Multijet/4x2/Off-Road-Look/1.4Multi-Air/2.0Multijet/4x4	SUV auf Fiat 500 Basis	e3*2007/46*0318*	334	01.15-	6½J x16	215/60R16			16213	R1-1918	4250906819183	8887	FL516008	65	110	5	40	30	105,40
Bravo	1.4-16V/1.4T-JET-16V/1.6D-Multijet-16V/1.9D-Multijet-8V/1.9D-Multijet-16V/2.0D-Multijet-16V		e3*2001/116*0248*, e3*2001/116*0288*	198	04.07-07.14	6J x15	195/65R15			15039	R1-1118	4250906811187	7835	FL515012	58	98	4	31,5	40	99,90
Cinquecento	0.9i.e./SX/1.1Hobby/Sporting/Soleil	silber	G108, e3*96/27*0023*	170	05.95-03.98	4,50 B x13	145/70R13	155/65R13		13099	R1-1004	4250906810043	2450	FL513008	58	98	4	36,5	63	78,90
Croma	1.8-16V/1.9D-Multijet-8V/1.9D-Multijet-16V/2.2-16V/2.4D-Multijet-20V		e3*2001/116*0210*	194	08.05-11.07	6½J x16	205/55R16	215/55R16		16045	R1-1483	4250906814836	9455	SA516002	65	110	5	41	25	107,90
Croma (Facelift)	1.8-16V/1.9D-Multijet-8V/1.9D-Multijet-16V/2.2-16V/2.4D-Multijet-20V		ab e3*2001/116*0210*05	194	12.07-12.10	6½J x16	205/55R16	215/55R16		16123	R1-1715	4250906817158	9437	FL516003	65	110	5	36	30	116,70
Doblò	1.3D-Multijet-16V/1.4-8V/1.9D-Multijet-8V		ab e3*98/14*0071*06	223	09.05-01.10	5½J x15	185/65R15			15078	R1-1626	4250906816267	6815	FL615004	58	98	4	32	48	105,20
Doblò	1.3-16V-Multijet/1.4/1.6D-Multijet/2.0-16V-Multijet		e3*2007/46*0002", -/07*	263	01.10-	6J x16	195/60R16			16154	R1-1786	4250906817868	8049	FL516002	58	98	5	36,5	30	101,10
Doblò Light	1.3/1.4/1.6D/2.0D	Achslast 1.150 kg - silber	e3*2007/46*0002*	263	01.10-	6J x15	185/65R15			15233	R1-1743	4250906817431	8737	FL515024	58	98	5	39	40	89,30
Doblò Heavy	1.3/1.4/1.6D/2.0D	Achslast 1.300 kg - schwarz	e3*2007/46*0002*	263	01.10-	6J x15	185/65R15			15232	R1-1741	4250906817417	7395	FL615006	58	98	5	39	48	100,90
Ducato Kombi	2.0i/2.8D/2.8JTD	Radlast 1.000 kg	e3*98/14*0102*	244	03.02-06.06	6J x15	195/70R15	205/70R15		15273	R1-1908	4250906819084	4011	FL615007	71,1	118	5	68	40	108,90
Ducato Kombi	2.0i/2.8D/2.8JTD	Radlast 1.000 kg	e3*98/14*0102*	244	03.02-06.06	6J x15	195/70R15	205/70R15		15281	R1-1941	4250906819411	4012		71,1	118	5	68	40	108,90
Ducato II Kombi	100-Multijet(2.2D)/120-Multijet(2.3D)/160-Multijet(3.0D)/Naturalpower(3.0CNG)	Radlast 1.000 kg	bis e3*2001/116*0232*14, bis e3*2007/46*0044*08	250	06.06-03.14	6J x15	205/70R15	215/70R15	225/70R15	15273	R1-1908	4250906819084	4011	FL615007	71,1	118	5	68	40	108,90
Ducato II Kombi	100-Multijet(2.2D)/120-Multijet(2.3D)/160-Multijet(3.0D)/Naturalpower(3.0CNG)	Radlast 1.000 kg	bis e3*2001/116*0232*14, bis e3*2007/46*0044*08	250	06.06-03.14	6J x15	205/70R15	215/70R15	225/70R15	15281	R1-1941	4250906819411	4012		71,1	118	5	68	40	108,90
Ducato II Kombi	120-Multijet(2.3D)/160-Multijet(3.0D)/Naturalpower(3.0CNG)	Radlast 1.280 kg	bis e3*2001/116*0232*14, bis e3*2007/46*0044*08	250	07.06-03.14	6J x16	215/75R16	225/75R16		16209	R1-1910	4250906819107	7011	FL616009	78,1	130	5	68	30	133,90
Ducato II Kombi	120 Multijet 2.3D (88kW) / 160 Multijet Power 3.0D (116kW) / 3.0 Natural Power (100kW)	Radlast 1.200 kg	e3*2001/116*0232*, e3*2007/46*0044*	250	06.06-03.14	6J x16	215/75R16	225/75R16		16094	R1-1636	4250906816366	9601	FL616004	78,1	130	5	68	30	130,00
Ducato III Kombi	Multijet 130/150, Natural Power 140	Achslast 2.000 kg	ab e3*2007/46*0049*13, ab 2001/116*0232*16	250	04.14-	6J x15	215/70R15	225/70R15		15273	R1-1908	4250906819084	4011	FL615007	71,1	118	5	68	40	108,90
Ducato III Kombi	Multijet 130/150, Natural Power 140	Achslast 2.000 kg	ab e3*2007/46*0049*13, ab 2001/116*0232*16	250	04.14-	6J x15	215/70R15	225/70R15		15281	R1-1941	4250906819411	4012		71,1	118	5	68	40	108,90
Ducato III Kombi	Multijet 130/150, Natural Power 140	Achslast 2.200 kg	ab e3*2007/46*0049*13, ab 2001/116*0232*16	250	04.14-	6J x16	215/75R16	225/75R16		16208	R1-1909	4250906819091	6011	FL616008	71,1	118	5	68	25	141,60
Idea	1.2-16V/1.3D Multijet-16V/1.4-8V/1.4-16V		e3*2001/116*0153*	350	01.04-12.07	6J x14	185/65R14			14172	R1-1638	4250906816380	6875	FL514023	58	98	4	40	45	90,80
Idea	1.2-16V/1.3D-Multijet-16V/1.4-8V/1.4-16V/1.6D-Multijet-16V/1-9D-Multijet-8V		e3*2001/116*0153*	350	01.04-12.07	6J x15	195/60R15			15159	R1-1475	4250906814751	8185	FL515009	58	98	4	40	48	99,00
Linea	1.3D-Multijet/1.4-8V/1.4T-16V-T-Jet/1.6D-Multijet		e3*2001/116*0260*	323	07.07-10.10	6J x15	185/65R15	195/60R15		15211	R1-1681	4250906816816	7680	FL515013	58	98	4	44	40	100,30
Multipla	1.6-16V/1.6 Natural-Power/1.9D-Multijet-8V		e3*96/79*0042*, e3*98/14*0050*, e3*98/14*0042*, e3*98/1400090*	186	04.99-02.10	6J x15	185/65R15			15039	R1-1118	4250906811187	7835	FL515006	58	98	4	31,5	40	99,90
Panda/Classic	1.1-8V/1.2-8V/1.2-8V-Natural Power/1.3D-Multijet-16V		e3*2001/116*0151*, e3*2001/116*0287*	169	09.03-02.12	5,00 B x13	155/80R13			13115	R1-1471	4250906814713	4450	FL513011	58	98	4	35	54	75,60

Modell- bezeichnung	Motorvarianten	Bemerkungen	ABE-Nummer	Fahrzeugtyp	Bauzeit von/bis	Radab- messung	Reifengröße			MWD- Nr.	MW-AM Nr.	EAN-Nr.	Alcar- Nr.	KPZ- Nr.	Bemerk.	Anschlussmaße				Stk. p.Pal.	Preis in € exkl. MwSt.		
Car model	Motorversion	General remarks	ABE-Number	Project Code	Production year	Wheel Size	Tyre Size			MWD- Ref.	MW-AM Ref.	EAN-Nr.	Alcar- Ref.	KPZ- Ref.	Remarks	Techn. Connection				Qty. p.Pal.	Price in € without TVA		
																Center hole	Pitch circle diameter	Hole number	Offset in mm				

Fiat (Fortsetzung)

Panda/Classic	1.1-8V/1.2-8V/1.2-8V-Natural Power/1.3D-Multijet-16V	schwarz, unterschiedliche Ventilochanordnung wegen anderer Zierblenden	e3*2001/116*0151*, e3*2001/116*0287*	169	09.03-02.12	5,00B x13	155/80R13				13120	R1-1803	4250906818032			58	98	4	35	63	60,40
Panda/Classic/4x4	4x4/1.2-8V/1.3D-16V-Multijet/Cross/Climbing / 4x2/1.4-16V		e3*2001/116*0151*	169	05.05-02.12	5 1/2 J x14	165/70R14	175/65R14	185/65R14		14119	R1-1121	4250906811217	6165	FL514018	58	98	4	35	54	83,90
Panda	0.9-8V/1.0-Hybrid/1.2-8V/1.3D-16V-Multijet	schwarz	e3*2007/46*0064*	312	03.12-	5 1/2 J x14	165/65R14	165/70R14	175/65R14		14176	R1-1689	4250906816892	6315	FL514026	58	98	4	35	54	75,60
Panda	0.9-8V/1.0-Hybrid/1.2-8V/1.3D-16V-Multijet	silber	e3*2007/46*0064*	312	03.12-	5 1/2 J x14	165/65R14	165/70R14	175/65R14		14210	R1-2063	4250906820639	6315	FL514026	58	98	4	35	54	75,60
Panda/4x4/Cross/City Cross	0.9-8V1.0-Hybrid/1.2-8V/1.3D-16V-Multijet/4x4/4x2		e3*2007/46*0064*	312	10.12-	6 J x15	175/65R15				15247	R1-1826	4250906818261	7355	FL515023	58	98	4	35	48	94,90
Punto	1.2i-60/1.2i-80/1.2i-8V/1.2i-16V/1.3JTD-16V/1.4i-16V/1.9D-60/1.9TD-80/1.9JTD		e3*98/14*0048*	188	11.99-08.05	5 1/2 J x14	165/70R14	185/60R14			14119	R1-1121	4250906811217	6165	FL514018	58	98	4	35	54	83,90
Punto/Grande Punto EVO	1.2-8V/1.3D-Multijet-16V/1.4-8V/1.4-Starjet-16V/1.4-16V-Multiair/1.4-8V-Natural Power/1.6-16V-Multijet/1.9D-Multijet-8V		e3*2001/116*0217*, -/286*	199	10.05-12.18	6 J x15	175/65R15	185/65R15			15185	R1-1593	4250906815932	7915	FL515010	56,5	100	4	43	40	88,70
Qubo	1.3D-16V-Multijet/1.4-8V/1.4-8V Natural-Power		e3*2001/116*0271*, e3*2007/46*0011*	225	02.08-	6 J x15	185/65R15				15211	R1-1681	4250906816816	7680	FL515013	58	98	4	44	40	100,30
Scudo Kombi (Facelift)	1.6i/1.9D/2.0i-16V/2.0JTD-8V/2.0JTD-16V		e2*2001/116*0162*, H261	220/220P	02.04-01.07	6 1/2 J x15	205/65R15				15198	R1-1643	4250906816434	9385		58	98	5	31	40	105,40
Scudo II Kombi	90-Multijet (1.6D)/120-Multijet (2.0D)/140-Multijet (2.0D)/L1H1/L2H1		e2*2001/116*0351*, e2*2007/46*0056*	270	02.07-08.16	7 J x16	215/60R16				16098	R1-1675	4250906816755	7780	PS616001	65	108	5	42	30	118,40
Sedici	1.6-16V/1.9D-Multijet-8V/2.0D-16V-Multijet/4x2/4x4	abgelöst durch Fiat 500X	e4*2001/116*0106	FY	05.06-12.14	6 J x15	195/65R15				15210	R1-1706	4250906817066	7150	SU515002	60	114,3	5	50	40	104,40
Sedici	1.6-16V/1.9D-Multijet-8V/2.0D-16V-Multijet/4x2/4x4	abgelöst durch Fiat 500X	e4*2001/116*0106	FY	05.06-12.14	6 J x16	205/60R16				16096	R1-1665	4250906816656	8315	SU516004	60	114,3	5	50	30	115,10
Seicento	0.9i/1.1i-8V		e3*96/79*0036*, e3*98/14*0036*	187	04.98-06.07	5,00B x13	145/70R13	155/65R13	155/70R13		13072	R1-1280	4250906812801	3450	FL513009	58	98	4	33	54	89,90
Stilo/Stilo Multi Wagon	1.2i-16V/1.4-16V/1.6i-16V/1.8i-16V/1.9D-Multijet 8V/1.9D-Multijet 16V		e3*98/14*0089*	192	11.01-05.08	6 1/2 J x15	195/65R15				15122	R1-1159	4250906811590	8085	FL515008	58	98	4	43	40	103,20
Talento	1.6/2.0 Ecojet/Multijet95/120/125/145	nur Fahrzeugklasse M1	e2*2007/46*0496*	FJL	09.16-	6 J x16	215/65R16				16202	R1-1896	4250906818964	7503	RE616016	66	114,3	5	50	30	111,90
Tipo	1.3 Multijet/1.4T-Jet/1.4-16V/1.6 Multijet/1.6E-torQ		e3*2007/46*0373*	356	06.16-	6 J x15	195/65R15				15288	R1-1963	4250906819633	4105	FL515025	58	98	5	38	48	88,80
Tipo	1.3 Multijet/1.4T-Jet/1.4-16V/1.6 Multijet		e3*2007/46*0373*	356	06.16-	6 1/2 J x16	205/55R16				16228	R1-1964	4250906819640	7105	FL516009	58	98	5	39	30	103,30
Ulysse	2.2JTD		e2*98/14*0255*	179	06.04-	7 J x16	215/60R16				16050	R1-1470	4250906814706			58	98	5	27	30	114,70
Ulysse-E	Elektro (100kW)		ab e2*2007/46*0532*18	V	12.21-	7 J x16	215/65R16				16237	R1-1980	4250906819800	7505	PS616003	65	108	5	46	30	105,40
Ulysse-E	Elektro (100kW)		ab e2*2007/46*0532*18	V	12.21-	7 J x17	225/55R17				17035	R1-2046	4250906820462	9026		65	108	5	46	25	136,20

Fiat Nfz.

Doblò Cargo	1.3JTD-16V Multijet-16V/1.4-8V/1.9D-Multijet-8V		K750	223L	09.05-01.10	5 1/2 J x 15	185/65R15			15078	R1-1626	4250906816267	6815	FL615004	58	98	4	32	48	105,20
Doblò Cargo	1.3D-16V-Multijet / 1.6-16V-Multijet	Achslast 1.150 kg - silber	e3*2007/46*0002*,-/07*	263	01.10-	6 J x 15	195/65R15			15233	R1-1743	4250906817431	8737	FL515024	58	98	5	39	40	89,30
Doblò Cargo	1.3D-16V-Multijet / 1.6-16V-Multijet	schwarz	e3*2007/46*0002*,-/07*	263	01.10-	6 J x 15	185/65R15	195/65R15		15232	R1-1741	4250906817417	7395	FL615006	58	98	5	39	48	100,90
Doblò Cargo/Maxi	1.3D-Multijet/1.4D-Multijet/2.0D-Multijet		e3*2007/46*0002*,-/07*	263	01.10-	6 J x 16	195/60R16			16154	R1-1786	4250906817868	8049	FL516002	58	98	5	36,5	30	101,10
Doblò Cargo (Mj. 2022)	1.2-PureTech 110				07.22-	6 1/2 J x 15	195/65R15			15302	R1-2056	4250906820561	5477	PS615004	65	108	5	42	40	102,60
Doblò Cargo/E-Doblò (Mj. 2022)	1.2-PureTech/1.5HDI/E-Doblò Elektroantrieb (100kW)				07.22-	6 1/2 J x 16	205/60R16	215/65R16		16289	R1-2094	4250906820943	7461	PS616004	65	108	5	47	30	108,30
Ducato	230/230D/230L/230M/230P		G687, G688, G715, G830, K861, e3*96/27*0025*	230/230D/230L/230M/230P	03.94-02.02	6 J x 15	195/70R15	205/70R15		15273	R1-1908	4250906819084	4011	FL615007	71,1	118	5	68	40	108,90
Ducato	230/230D/230L/230M/230P		G687, G688, G715, G830, K861, e3*96/27*0025*	230/230D/230L/230M/230P	03.94-02.02	6 J x 15	195/70R15	205/70R15		15281	R1-1941	4250906819411	4012		71,1	118	5	68	40	108,90
Ducato Maxi	230/230D/230L/230M		G687, G688, G830, K861	230/230D/230L/230M	03.94-02.02	6 J x 16	205/75R16	215/75R16		16094	R1-1636	4250906816366	9601	FL616004	78,1	130	5	68	30	130,00
Ducato I (Facelift)	1.9D/1.9TD/2.0Bipower/2.0i/2.3JTD/2.8JTD		K916, K917, K918, L094	244/244D/244L/244M	03.02-06.06	6 J x 15	195/70R15	205/70R15		15273	R1-1908	4250906819084	4011	FL615007	71,1	118	5	68	40	108,90
Ducato I (Facelift)	1.9D/1.9TD/2.0Bipower/2.0i/2.3JTD/2.8JTD		K916, K917, K918, L094	244/244D/244L/244M	03.02-06.06	6 J x 15	195/70R15	205/70R15		15281	R1-1941	4250906819411	4012		71,1	118	5	68	40	108,90
Ducato I (Facelift)	2.0 Bipower/2.0i/2.3JTD/2.8JTD		K916, K917, K918, L051	244/244B244L/244M	03.02-06.06	6 J x 16	205/75R16	215/75R16		16094	R1-1636	4250906816366	9601	FL616004	78,1	130	5	68	30	130,00
Ducato II	100-Multijet(2.2D)/120-Multijet(2.3D)/160-Multijet(3.0D)/Naturalpower(3.0CNG)		L778, L779, L968, N413	250/250D/250L/250M	07.06-06.12	6 J x 15	205/70R15	215/70R15	225/70R15	15273	R1-1908	4250906819084	4011	FL615007	71,1	118	5	68	40	108,90
Ducato II	100-Multijet(2.2D)/120-Multijet(2.3D)/160-Multijet(3.0D)/Naturalpower(3.0CNG)		L778, L779, L968, N413	250/250D/250L/250M	07.06-06.12	6 J x 15	205/70R15	215/70R15	225/70R15	15281	R1-1941	4250906819411	4012		71,1	118	5	68	40	108,90
Ducato II Maxi	120-Multijet(2.3D) / 160-Multijet(3.0D) / Naturalpower(3.0CNG)		L778, L779, L968, N413	250/250D/250L/250M	07.06-06.12	6 J x 16	215/75R16	225/75R16		16209	R1-1910	4250906819107	7011	FL616009	78,1	130	5	68	30	133,90
Ducato II/Maxi	120-Multijet(2.3D) / 160-Multijet(3.0D) / Naturalpower(3.0CNG)		L778, L779, L968, N413	250/250D/250L/250M	06.06-06.12	6 J x 16	215/75R16	225/75R16		16094	R1-1636	4250906816366	9601	FL616004	78,1	130	5	68	30	130,00
Ducato II (Facelift)	115-M(2.0D)/130-M(2.3D)/150-M(2.3D)/180-M(3.0D)/140-Naturalpower(3.0CNG)		bis e3*2007/46*0044*08, bis e3*2007/46*0049*07	250	07.12-03.14	6 J x 15	205/70R15	215/70R15	225/70R15	15273	R1-1908	4250906819084	4011	FL615007	71,1	118	5	68	40	108,90
Ducato II (Facelift)	115-M(2.0D)/130-M(2.3D)/150-M(2.3D)/180-M(3.0D)/140-Naturalpower(3.0CNG)		bis e3*2007/46*0044*08, bis e3*2007/46*0049*07	250	07.12-03.14	6 J x 15	205/70R15	215/70R15	225/70R15	15281	R1-1941	4250906819411	4012		71,1	118	5	68	40	108,90
Ducato II/Maxi (Facelift)	130-M(2.3D)/150-M(2.3D)/180-M(3.0D)/140-Naturalpower(3.0CNG)		bis e3*2007/46*0044*08, bis e3*2007/46*0049*07	250	07.12-03.14	6 J x 16	215/75R16	225/75R16		16209	R1-1910	4250906819107	7011	FL616009	78,1	130	5	68	30	133,90
Ducato II/Maxi	130-MJ(2.3D)/150-MJ(2.3D)/180-MJ(3.0D)/140-Natural Power(3.0CNG)		bis e3*2007/46*0044*08, bis e3*2007/46*0049*07	250	07.12-03.14	6 J x 16	215/75R16	225/75R16		16094	R1-1636	4250906816366	9601	FL616004	78,1	130	5	68	30	130,00
Ducato III	Multijet 115/130/140/150/160/180		ab e3*2001/116*0232*16, ab e3*2007/46*0044*13, ab e3*2007/46*0049*10	250	04.14-	6 J x 15	215/70R15	225/70R15		15273	R1-1908	4250906819084	4011	FL615007	71,1	118	5	68	40	108,90
Ducato III/Maxi	Multijet 115/130/140/150/160/180		ab e3*2001/116*0232*16, ab e3*2007/46*0044*13, ab e3*2007/46*0049*10	250	04.14-	6 J x 15	215/70R15	225/70R15		15281	R1-1941	4250906819411	4012		71,1	118	5	68	40	108,90

Modell- bezeichnung	Motorvarianten	Bemerkungen	ABE-Nummer	Fahrzeugtyp	Bauzeit von/bis	Radab- messung	Reifengröße		MWD- Nr.	MW-AM Nr.	EAN-Nr.	Alcar- Nr.	KPZ- Nr.	Bemerk.	Anschlussmaße				Stk. p.Pal.	Preis in € exkl. MwSt.
Car model	Motorversion	General remarks	ABE-Number	Project Code	Production year	Wheel Size	Tyre Size		MWD- Ref.	MW-AM Ref.	EAN-Nr.	Alcar- Ref.	KPZ- Ref.	Remarks	Techn. Connection				Qty. p.Pal.	Price in € without TVA
															Center hole	Pitch circle diameter	Hole number	Offset in mm		

Fiat Nfz. (Fortsetzung)

Ducato III/Maxi	Multijet 130/140CNG/150/180		ab e3*2001/116*0232*16, ab e3*2007/46*0044*13, ab e3*2007/46*0049*10	250	04.14-	6 J x16	215/75R16	225/75R16		16209	R1-1910	4250906819107	7011	FL616009	78,1	130	5	68	30	133,90
Fiorino	1.3D-16V-Multijet/1.4-8V/1.4-8V Naturalpower		N157, e3*2007/46*0011*	225L/225	02.08-	6 J x15	185/65R15			15211	R1-1681	4250906816816	7680	FL515013	58	98	4	44	40	100,30
Scudo (Facelift)	1.9JTD/2.0JTD/2.0i-16V		H105	220L	02.04-12.06	6 1/2 J x15	195/65R15	205/65R15		15198	R1-1643	4250906816434	9385		58	98	5	31	40	105,40
Scudo II Kasten	90-Multijet (1.6D)/120-Multijet (2.0D)/140-Multijet (2.0D)/L1H1/L2H1		L862	270L	01.07-08.16	7 J x16	215/60R16			16098	R1-1675	4250906816755	7780	PS616001	65	108	5	42	30	118,40
Scudo III/E-Scudo	1.5 Multijet-100/120/2.0 Multijet 145/180		ab e2*2007/46*0533*20	V	12.21-	7 J x16	215/65R16			16237	R1-1980	4250906819800	7505		65	108	5	46	30	105,40
Scudo III/E-Scudo	1.5 Multijet-100/120/2.0 Multijet 145/180		ab e2*2007/46*0533*20	V	12.21-	7 J x17	215/60R17			17035	R1-2046	4250906820462	9026		65	108	5	46	25	136,20
Talento	1.6/2.0 Ecojet/Multijet 90/95/115/120/125/145/170	nur Fahrzeugklasse N1	e2*2007/46*0497*	FFL	09.16-	6 J x16	205/65R16	215/65R16		16202	R1-1896	4250906818964	7503	RE616016	66	114,3	5	50	30	111,90

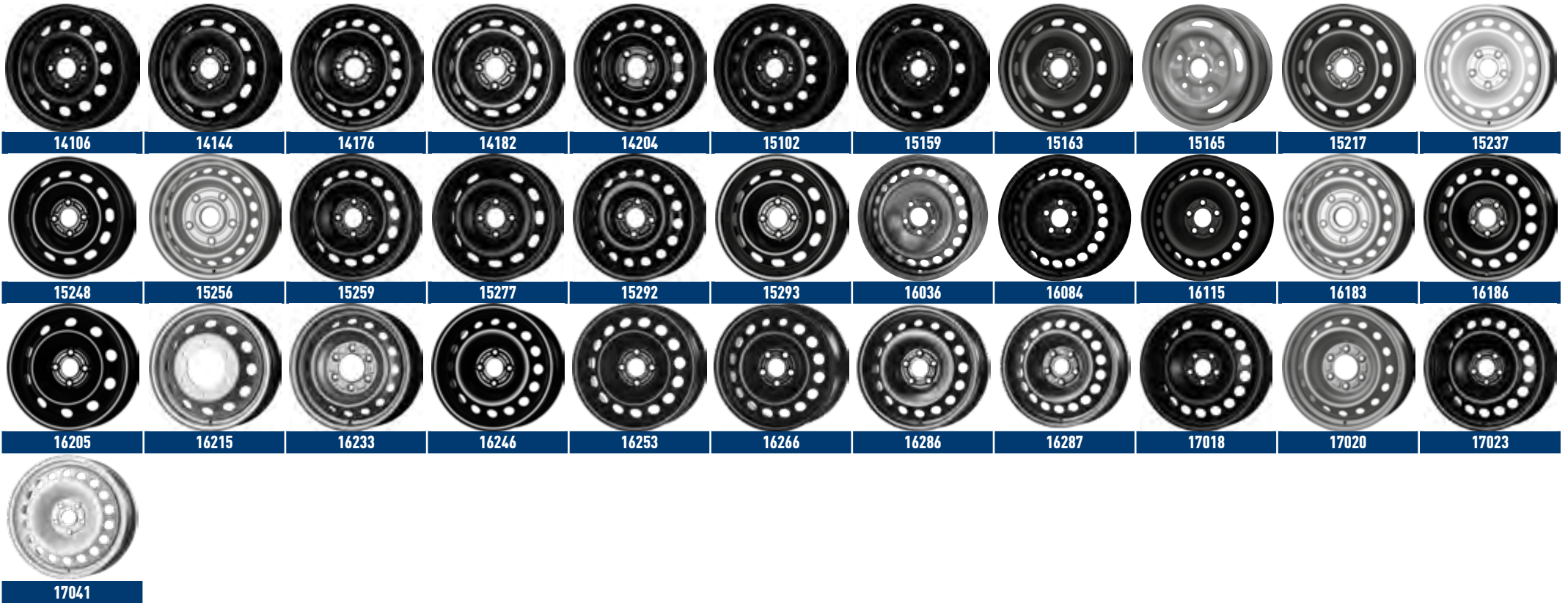

B-Max	1.0/1.4/1.4LPG/1.5TDCi/1.6TDCi/1.6Ti-VCT	e9*2007/46*0092*, e13*2007/46*1380*	JK8/JK8-LPG	07.12-12.17	6J x15	185/60R15	195/60R15			15248	R1-1847	4250906818476	5000	F0515016	63,3	108	4	37,5	40	87,00
C-Max	1.6/1.6Ti-VCT/1.6-TDCi/1.8/2.0-TDCi	e13*2001/116*0109*	DM2	09.03-10.10	6J x15	195/65R15				15163	R1-1522	4250906815222	8795	F0515014	63,3	108	5	52,5	40	91,00
C-Max	1.6/1.6Ti-VCT/1.6-TDCi/1.8/1.8-TDCi/2.0/2.0-TDCi	e13*2001/116*0109*	DM2	09.03-10.10	6½J x16	205/55R16				16036	R1-1557	4250906815574	9975	F0516005	63,3	108	5	52,5	30	100,70
C-Max	1.6/1.6-TDCi/1.8/1.8-Flexfuel/2.0/2.0-TDCi/2.0-CNG/2.0-LPG	ab e13*2001/116*0109*15, e13*2001/116*1000*, -/1018*	DM2/DM2-LPG/DM2-CNG	03.07-10.10	6½J x16	205/55R16				16115	R1-1707	4250906817073	8325	F0516008	63,3	108	5	50	30	92,60
C-Max/Grand C-Max	1.6SCTi/1.6TDCi/1.6LPG/2.0TDCi/2.0Energi	e13*2007/46*1103*, -/1288*, e13*KS07/46*1465*	DXA/DXA-LPG/DXA-PHEV	11.10-12.19	6½J x16	205/55R16	215/55R16	215/60R16		16115	R1-1707	4250906817073	8325	F0516008	63,3	108	5	50	30	92,60
EcoSport	1.0-EcoBoost/1.5Ti-VCT/1.5-TDCi	bis e9*2007/46*0092*17	JK8	01.14-01.18	6J x15	195/65R15				15259	R1-1923	4250906819237	8442	F0515018	63,3	108	4	37,5	40	95,70
EcoSport	1.0-EcoBoost/1.5Ti-VCT/1.5-TDCi	bis e9*2007/46*0092*17	JK8	01.14-01.18	6J x16	205/60R16				16205	R1-1940	4250906819404			63,3	108	4	37,5	30	97,20
EcoSport (Facelift)	1.0-EcoBoost/1.5-EcoBlue/1.5-TDCi	ab e9*2007/46*0092*19	JK8	02.18-	6½J x16	205/60R16				16253	R1-2038	4250906820387	7442	F0516012	63,3	108	4	37,5	30	104,70
Fiesta V	1.3i-8V/1.4i-16V/1.4-TDCi/1.6i-16V/1.6-TDCi	e1*98/14*0191*, e1*2001/116*0210*	JH1/JD3	02.02-09.08	5½J x14	175/65R14				14144	R1-1464	4250906814645	6275	F0514010	63,3	108	4	47,5	54	82,10

Modell- bezeichnung	Motorvarianten	Bemerkungen	ABE-Nummer	Fahrzeugtyp	Bauzeit von/bis	Radab- messung	Reifengröße			MWD- Nr.	MW-AM Nr.	EAN-Nr.	Alcar- Nr.	KPZ- Nr.	Bemerk.	Anschlussmaße				Stk. p.Pal.	Preis in € exkl. MwSt.
Car model	Motorversion	General remarks	ABE-Number	Project Code	Production year	Wheel Size	Tyre Size			MWD- Ref.	MW-AM Ref.	EAN-Nr.	Alcar- Ref.	KPZ- Ref.	Remarks	Techn. Connection				Qty. p.Pal.	Price in € without TVA
																Center hole	Pitch circle diameter	Hole number	Offset in mm		

Ford (Fortsetzung)

Fiesta V/ST150	1.3i-8V/1.4i-16V/1.4-TDCi/1.6i-16V/1.6-TDCi/ST150		e1*98/14*0191*, e1*2001/116*0210*	JH1/JD3	02.02-09.08	6 J x 15	185/55R15	195/50R15		15102	R1-1338	4250906813389	8200	F0515007		63,3	108	4	52,5	40	88,90
Fiesta VI	1.25/1.4/1.4LPG/1.6Ti-VCT/1.6-TDCi		bis e9*2001/116*0069*10, bis e13*2007/46*1058*08	JA8/JA8-LPG	10.08-12.12	5 1/2 J x 14	175/65R14			14182	R1-1738	4250906817387	6355	F0514011		63,3	108	4	37,5	54	79,90
Fiesta VI	1.25/1.4/1.4LPG/1.6Ti-VCT/1.6-TDCi		bis e9*2001/116*0069*10, bis e13*2007/46*1058*08	JA8/JA8-LPG	10.08-12.12	6 J x 15	195/50R15	195/60R15		15217	R1-1730	4250906817301	7255	F0515015		63,3	108	4	47,5	40	86,00
Fiesta VI (Facelift)	1.0/1.25/1.4LPG/1.5TDCi/1.6Ti-VCT/1.6TDCi		ab e9*2001/116*0069*11, ab e13*2007/46*1058*09	JA8/JA8-LPG	01.13-05.17	5 1/2 J x 14	175/65R14			14182	R1-1738	4250906817387	6355	F0514011		63,3	108	4	37,5	54	79,90
Fiesta VI (Facelift)	1.0/1.25/1.4LPG/1.5TDCi/1.6Ti-VCT/1.6TDCi		ab e9*2001/116*0069*11, ab e13*2007/46*1058*09	JA8/JA8-LPG	01.13-05.17	6 J x 15	195/50R15	195/55R15	195/60R15	15217	R1-1730	4250906817301	7255	F0515015		63,3	108	4	47,5	40	86,00
Fiesta VII	1.0/1.1/1.5TDCi/1.6ST		e9*2007/46*3142*, -/3159*, e13*2007/46*2148*	JHH/JGH/JHHL	06.17-	6 J x 15	195/60R15			15293	R1-2008	4250906820080	4095	F0515021		63,3	108	4	45	40	79,60
Fiesta VII	1.0/1.1/1.5TDCi		e9*2007/46*3142*, -/3159*, e13*2007/46*2148*	JHH/JGH/JHHL	06.17-	6 1/2 J x 16	195/55R16			16246	R1-2009	4250906820097	7095	F0516011		63,3	108	4	47,5	30	96,70
Focus	1.4i/1.6i/1.8i/1.8i-Zetec/2.0i-Zetec/1.8TDDi/1.8TDCi		e13*97/27*0037*, -/38*, -/39*, -/40*, e13*98/14*0056*, -/57*, -/58*, e13*98/14D0056*, -/57*, -/58*	DAW/DBW/DFW/DNW/DAX/DBX/DNX	11.98-09.04	5 1/2 J x 14	175/70R14	185/65R14		14106	R1-1330	4250906813303	6880	F0514007		63,3	108	4	47,5	54	88,90
Focus	1.4i/1.6i/1.8i/1.8i-Zetec/2.0i-Zetec/1.8TDDi/1.8TDCi		e13*97/27*0037*, -/38*, -/39*, -/40*, e13*98/14*0056*, -/57*, -/58*, e13*98/14D0056*, -/57*, -/58*	DAW/DBW/DFW/DNW/DAX/DBX/DNX	11.98-09.04	6 J x 15	195/55R15	195/60R15		15102	R1-1338	4250906813389	8200	F0515007		63,3	108	4	52,5	40	88,90
Focus II	1.4/1.6/1.6Ti-VCT/1.6-TDCi/1.8		e13*2001/116*0144*, -/157*	DA3/DB3	10.04-03.11	6 J x 15	195/65R15			15163	R1-1522	4250906815222	8795	F0515014		63,3	108	5	52,5	40	91,00
Focus II/CC/ST220	1.4/1.6/1.6Ti-VCT/1.6-TDCi/1.8/2.0/2.0-TDCi/ST220 Cabrio 1.6/2.0/2.0TDCi		e13*2001/116*0144*, -/157*	DA3/DB3	10.04-03.11	6 1/2 J x 16	205/55R16			16036	R1-1557	4250906815574	9975	F0516005		63,3	108	5	52,5	30	100,70
Focus II/CC	1.4/1.6/1.6Ti-VCT/1.6-TDCi/1.8/2.0/2.0-TDCi/2.0CNG/2.0LPG Cabrio 1.6/2.0/2.0TDCi		e13*2001/116*0144*, -/157*, -/999*, -/1017*	DA3/DB3/DA3-LPG/DA3-CNG	03.07-03.11	6 1/2 J x 16	205/55R16			16115	R1-1707	4250906817073	8325	F0516008		63,3	108	5	50	30	92,60
Focus III	1.0-EcoBoost/1.6Ti-VCT/1.6-EcoBoost/1.6TDCi/1.6LPG/2.0TDCi/Focus electric		e13*2007/46*1138, -/1289*, -/1390*	DYB/DYB-LPG/DYB-BEV	04.11-08.18	6 1/2 J x 16	205/55R16	215/55R16	215/60R16	16115	R1-1707	4250906817073	8325	F0516008		63,3	108	5	50	30	92,60
Focus IV	1.0/1.5-EcoBoost/1.5D/2.0D-EcoBlue		e13*2007/46*1911	DEH	09.18-	6 1/2 J x 16	195/65R16	205/60R16		16115	R1-1707	4250906817073	8325	F0516008		63,3	108	5	50	30	92,60
Fusion	1.25/1.4/1.4TDCi/1.6/1.6TDCi		bis e1*98/14*0194*25	JU2	08.02-06.12	5 1/2 J x 14	185/60R14			14144	R1-1464	4250906814645	6275	F0514010		63,3	108	4	47,5	54	82,10
Galaxy II	1.8TDCi/2.0/2.0-Flexfuel/2.0TDCi/2.0STCi/2.2TDCi/2.3		bis e13*2001/116*0185*23	WA6	05.06-08.15	6 1/2 J x 16	215/60R16			16084	R1-1645	4250906816458	8465	F0516007		63,3	108	5	50	30	103,90
Galaxy III	1.5EcoBoost/2.0EcoBoost/2.0TDCi/2.0TDCi Bi-Turbo/4WD / 2.5 Duratec Hybrid		ab e13*2001/116*0185*24, e13*2007/46*2374*	WA6/WAH6	09.15-	7 1/2 J x 17	235/55R17			17018	R1-1948	4250906819480	9001	F0517004		63,3	108	5	55	20	127,10
KA II	1.2/1.3TDCi	schwarz	e3*2001/116*0280*	RU8	01.09-08.16	5 1/2 J x 14	165/65R14	175/65R14		14176	R1-1689	4250906816892	7360	FL514026		58	98	4	35	54	75,60
KA II	1.2/1.3TDCi	silber	e3*2001/116*0280*	RU8	01.09-08.16	5 1/2 J x 14	165/65R14	175/65R14		14210	R1-2063	4250906820639	7360	FL514026		58	98	4	35	54	75,60
KA II	1.2/1.3TDCi		e3*2001/116*0280*	RU8	01.09-08.16	6 J x 15	195/50R15			15159	R1-1475	4250906814751	8185	FL515009		58	98	4	40	48	99,00

Modell- bezeichnung	Motorvarianten	Bemerkungen	ABE-Nummer	Fahrzeugtyp	Bauzeit von/bis	Radab- messung	Reifengröße		MWD- Nr.	MW-AM Nr.	EAN-Nr.	Alcar- Nr.	KPZ- Nr.	Bemerk.	Anschlussmaße				Stk. p.Pal.	Preis in € exkl. MwSt.
Car model	Motorversion	General remarks	ABE-Number	Project Code	Production year	Wheel Size	Tyre Size		MWD- Ref.	MW-AM Ref.	EAN-Nr.	Alcar- Ref.	KPZ- Ref.	Remarks	Techn. Connection				Qty. p.Pal.	Price in € without TVA
															Center hole	Pitch circle diameter	Hole number	Offset in mm		

Ford Nfz.

Fiesta Van	1.3i/1.4TDCi/1.6i/1.6TDCi		N070	JC3	04.07-12.08	5 1/2 J x 14	175/65R14			14144	R1-1464	4250906814645	6275	F0514010		63,3	108	4	47,5	54	82,10
Fiesta Van	1.3i/1.4TDCi/1.6TDCi		N070	JC3	04.07-12.08	6 J x 15	195/50R15			15102	R1-1338	4250906813389	8200	F0515007		63,3	108	4	52,5	40	88,90
Fiesta Van	1.25/1.4TDCi/1.6TDCi		DE2007/46*0072* bis e9*2007/46*0002*06	JR8	01.09-12.12	5 1/2 J x 14	175/65R14			14182	R1-1738	4250906817387	6355	F0514011		63,3	108	4	37,5	54	79,90
Fiesta Van	1.25/1.4TDCi/1.6TDCi		DE2007/46*0072* bis e9*2007/46*0002*06	JR8	01.09-12.12	6 J x 15	195/50R15	195/60R15		15217	R1-1730	4250906817301	7255	F0515015		63,3	108	4	47,5	40	86,00
Fiesta Van (Facelift)	1.25i/1.5TDCi/1.6TDCi		ab e9*2007/46*0002*07	JR8	01.13-	5 1/2 J x 14	175/65R14			14182	R1-1738	4250906817387	6355	F0514011		63,3	108	4	37,5	54	79,90
Fiesta Van (Facelift)	1.25i/1.5TDCi/1.6TDCi		ab e9*2007/46*0002*07	JR8	01.13-	6 J x 15	195/50R15	195/55R15		15217	R1-1730	4250906817301	7255	F0515015		63,3	108	4	47,5	40	86,00
Ranger/Ranger 4x4	2.0TDCi/2.2TDCi/3.2TDCi		e11*2007/46*0154*, e5*2007/46*0080*	2AB	02.12-	7 J x 16	215/70R16	255/70R16		16233	R1-1973	4250906819732	7655			93	139,7	6	55	30	134,90
Transit Courier	1.0/1.5TDCi/1.6TDCi		ab e13*2007/46*1349*01	JN8	06.14-	6 J x 15	185/60R15	195/60R15		15277	R1-1925	4250906819251	5005	F0615010		63,3	108	4	37,5	40	96,40
Transit Connect	1.0/1.6/1.6TDCi	M12 x 1,5	ab e1*2001/116*0207*16 bis*/25, ab e1*2007/46*0272*04 bis */13	PJ2/PU2	11.13-06.18	6 1/2 J x 16	205/60R16	215/55R16		16186	R1-1886	4250906818865	9232	F0616010		63,3	108	5	50	30	104,90
Transit Connect (Facelift)	1.0EcoBoost/1.5d EcoBlue	M14 x 1,5	ab e1*2001/116*0207*26, ab e1*2007/46*0272*14	PJ2/PU2	07.18-	6 1/2 J x 16	205/60R16	215/55R16		16266	R1-2047	4250906820479	7232	F0616012		63,3	108	5	50	30	116,00
Transit Connect	1.5-EcoBoost/2.0D-EcoBlue	Radlast 650 kg	e13*2018/858*00342*	SKN	07.22-	6 J x 15	205/65R15			15237	R1-1796	4250906817967	8385	V0615036		57	112	5	47	40	92,80
Transit Connect	1.5-EcoBoost/2.0D-EcoBlue	Radlast 720 kg	e13*2018/858*00342*	SKN	07.22-	6 1/2 J x 16	205/60R16			16287	R1-2090	4250906820905	8703			57	112	5	48	36	110,70
Transit Connect	1.5-EcoBoost/2.0D-EcoBlue		e13*2018/858*00342*	SKN	07.22-	6 1/2 J x 17	215/55R17			17041	R1-2091	4250906820912	9703			57	112	5	49	30	116,20
Transit	FT260/FT280/FT300/2.0TD/2.0TDE/2.0TDCi	nur für Frontantrieb	e11*98/14*0151*, -/152*, -/153*, -/154*, -/155*, -/156*, -/157*, -/172*, K710, K711, K712, K714, K715, K716	FBFY/FDEY/FDFY/FDGY/FSEY/FSFY/FSGY/FZEY/FAEY/FAFY/FAGY	01.01-05.06	5 1/2 J x 15	195/70R15			15165	R1-1421	4250906814218	8505	F0615005		65	160	5	60	48	134,10
Transit	FT260/280/300/330/350/2.2TDCi		L744, L745, L746, L751, L752, L758, e1*2007/46*0243*, -/244*, -/246*, -/255*, -/256*, -/268*	FAE6/FAF6/FAG6/FNF6/FMF6/FME6	06.06-12.14	5 1/2 J x 15	195/70R15			15165	R1-1421	4250906814218	8505	F0615005		65	160	5	60	48	134,10
Transit/Transit Custom	2.0TDCi/2.2TDCi		e1*2007/46*1005*, -/1100*, e11*2007/46*0676*, -/0801*, e5*2007/46*1032*	FCC/FAC/FAD/FCD	01.13-	6 1/2 J x 15	215/65R15			15256	R1-1863	4250906818636	8337	F0615009		65	160	5	60	40	115,90
Transit/Transit Custom	1.0TDCi-Hybrid/2.0TDCi/2.2TDCi/4x4		e1*2007/46*1005*, -/1096*, -/1097*, -/1098*, -/1100*, e11*2007/46*0676*, -/0801*, -/807*, e5*2007/46*032*, -/1033*	FCC/FAC/FAD/FED/FFD/FDD/FCD/FBD	01.13-	6 1/2 J x 16	215/65R16	235/65R16		16183	R1-1864	4250906818643	9118	F0616009		65	160	5	60	30	124,40
Transit	2.0TDCi/2.2TDCi	Bei Zwillingbereifung kein RDKS	e1*2007/46*1096*, -/1097*, -/1098*, -/1100*, e11*2007/46*0807*, e5*2007/46*1033*	FCD/FDD/FED/FFD/FBD	01.13-	6 J x 16	195/75R16			16215	R1-1924	4250906819244	9197	F0616011		138,8	180	6	109,5	30	145,60



14138 **15132** **15133** **15284** **16081** **16129** **16175**

Accord/Tourer	2.0/2.2i-DTEC		e6*2001/116*0113*, -/115*, -/120*, -/122*	CU1/CU3/CW1/CW3	07.08-07.16	6 1/2 J x 16	205/60R16	215/60R16		16129	R1-1739	4250906817394	9527	HO516007	64	114,3	5	50	30	129,10
Civic 3+4-türig	1.4iS/LS/1.6iS/LS/ES/1.7i-CTDi		e11*98/14*0158*, -/159*, -/160*, -/161*, -/173*, -/174*, 188*	EU5/EU6/EU7/EU8/EP1/EP2/EP4	03.01-12.05	5 1/2 J x 14	185/70R14			14138	R1-1148	4250906811484	5260	HO514010	56	100	4	45	48	87,50
Civic	1.3/1.4/1.8/2.2i-CDTi		bis e11*2001/116*0255*06, bis-/256*06, bis-/257*05, -/297*, -/298*, -/334*	FK1/FK2/FK3/FN1/FN3/FN4	01.06-01.12	6 1/2 J x 16	205/55R16			16081	R1-1610	4250906816106	8005	HO516006	64	114,3	5	55	30	116,20
Civic	1.4S/1.8S/2.2i-DTEC		ab e11*2001/116*0255*07, ab-/256*07, ab-/257*06, e11*2007/46*0186*	FK1/FK2/FK3/FB8	02.12-03.17	6 1/2 J x 16	205/55R16			16175	R1-1857	4250906818575	8067	HO516009	64	114,3	5	45	30	120,70
Civic	1.0VTEC/1.5VTEC/1.6i-DTEC		e11*2007/46*3633*, e6*2007/46*0256*	FC/FK	04.17-	7 J x 16	215/55R16			16251	R1-2035	4250906820356	7520	HO516011	64	114,3	5	45	30	120,90
CR-V	2.0i-S/ES/LS		e6*95/54*0044*, e6*98/14*0076*	RD1/RD3	06.97-05.02	6 J x 15	205/70R15			15133	R1-1176	4250906811767	8130	HO515009	64	114,3	5	50	36	129,00
CR-V	1.6i-DTEC/2.0i-VTEC/2.2i-DTEC/2WD/4WD		e11*2001/116*0301*06-09, -/302*06-*10	RE5/RE6	10.12-04.15	6 1/2 J x 17	225/65R17			17011	R1-1885	4250906818858	9312		64	114,3	5	50	25	151,40
HR-V	5DR/1.6i-2wd/1.6i-4wd/1.6i-4wd-CVT/1.6i-VTEC-4wd/3DR/1.6i-2wd/1.6i-VTEC-4wd		e6*98/14*0062*, -/63*, -/67*, -/68*	GH1/GH2/GH3/GH4	01.99-12.05	5 1/2 J x 15	195/70R15			15132	R1-1177	4250906811774	7930	HO515008	64	114,3	5	45	36	116,00
Jazz III	1.3i-VTEC		e6*2007/46*0162*	GK	10.15-05.20	6 J x 15	185/60R15			15284	R1-1949	4250906819497	4025	HO515019	56	100	4	50	48	100,60
Jazz IV Hybrid	1.5i-MMD		e6*2007/46*0415*	GR	06.20-	6 J x 15	185/60R15			15312	R1-2097	4250906820974	4026		56	100	4	50	40	109,10

Modell- bezeichnung	Motorvarianten	Bemerkungen	ABE-Nummer	Fahrzeugtyp	Bauzeit von/bis	Radab- messung	Reifengröße		MWD- Nr.	MW-AM Nr.	EAN-Nr.	Alcar- Nr.	KPZ- Nr.	Bemerk.	Anschlussmaße				Stk. p.Pal.	Preis in € exkl. MwSt.
Car model	Motorversion	General remarks	ABE-Number	Project Code	Production year	Wheel Size	Tyre Size		MWD- Ref.	MW-AM Ref.	EAN-Nr.	Alcar- Ref.	KPZ- Ref.	Remarks	Techn. Connection		Qty. p.Pal.	Price in € without TVA		
															Center hole	Pitch circle diameter	Hole number	Offset in mm		

Hyundai



Accent	1.3iL/GS/GLS/1.5iGS/GLS/1.5CRDi/1.6i-GLS		e4*98/14*0037*	LC	01.00-05.06	5 J x14	185/60R14			14133	R1-1548	4250906815482	5220	HY514005	54	100	4	46	54	108,10
Bayon	1.0T-GDI/1.0T-GDI Hybrid/1.2MPI/1.4MPI		e5*2007/46*0121*	BC3	10.20-	6 J x15	185/65R15			15282	R1-1942	4250906819428	5015	HY515020	54	100	4	47	40	93,70
Getz	1.1i/1.3i/1.4i/1.5CRDi/1.6i		e4*98/14*0066*	TB	09.02-01.09	5 J x14	165/65R14	175/65R14		14133	R1-1548	4250906815482	5220	HY514005	54	100	4	46	54	108,10
Getz	1.1i/1.4i/1.5CRDi/1.6i		e4*2001/116*0123*	TBI	01.07-01.09	5 J x14	165/65R14	175/65R14		14133	R1-1548	4250906815482	5220	HY514005	54	100	4	46	54	108,10
Ioniq Hybrid	1.6 GDi Hybrid/Electro 100kW	je nach Ausführung nur 17" zulässig	e4*2007/46*1157*	AE	08.16-	6 J x15	195/65R15			15295	R1-2014	4250906820141	4110		67	114,3	5	46	40	95,50
i10	1.0/1.1/1.25		bis e4*2001/116*0131*04	PA	03.08-02.11	4,00B x13	155/70R13			13116	R1-1572	4250906815727	2490	KI513003	54	100	4	46	72	91,20
i10 (Facelift)	1.0/1.1/1.25	Radkappe von 13116 - R1-1572 nicht passend	ab e4*2001/116*0131*05	PA	03.11-11.13	4,00B x13	155/70R13			13121	R1-1838	4250906818384	2491		54	100	4	46	72	89,70
i10	1.1/1.1CRDi/1.25		e4*2001/116*0131*	PA	03.08-11.13	5 J x14	165/60R14	175/60R14		14158	R1-1571	4250906815710	5490	KI514004	54	100	4	46	54	101,40
i10	1.0		e11*2007/46*1008*	JA	12.13-11.19	4 1/2 J x13	155/70R13			13122	R1-1902	4250906819022	4275	HY513009	54	100	4	35	63	91,20
i10	1.0/1.0LPG/1.2		e11*2007/46*1008*, e13*2007/46*1602*, e5*2007/46*1086*	JA/JA-HME	12.13-11.19	5 1/2 J x14	175/65R14			14197	R1-1903	4250906819039	5335	HY514010	54	100	4	47	54	80,90
i10	1.0/1.2		e5*2007/46*0090*	AC3	01.20-	5 1/2 J x14	175/65R14			14211	R1-2085	4250906820851	3553		54	100	4	42	54	83,60
i20	1.1CRDi/1.2/1.4/1.4CRDi/1.6/1.6CRDi		e11*2007/46*0129*, ab e11*2001/116*0333*03	PB/PBT	04.10-09.14	5 1/2 J x14	175/70R14			14186	R1-1790	4250906817905	6625	HY514009	54	100	4	46	63	105,60
i20 II	1.0/1.1CRDi/1.2/1.4/1.4CRDi/Hybrid/Active/Coupé		e11*2007/46*1600*, -/1603*, e5*2007/46*1087*	GB/GB-HME	10.14-09.20	6 J x15	185/65R15			15282	R1-1942	4250906819428	5015	HY515020	54	100	4	47	40	93,70
ix20	1.4/1.4CRDi/1.6/1.6CRDi		e4*2007/46*0207*, e4*2007/46*0223*, e13*2007/46*1605*	JC/JC-HME	11.10-	6 J x15	195/65R15			15265	R1-1901	4250906819015	8503	HY515017	67	114,3	5	48	48	92,90

i30/i30cw	1.4/1.6/1.6CRDi/2.0i/2.0CRDi	Tschechische Produktion	e11*2001/116*0343*, e11*2007/46*0225*	FDH	01.09-02.12	5 1/2 J x 15	185/65R15	195/65R15			15206	R1-1693	4250906816939	8077	KI515006	67	114,3	5	47	48	89,70	
i30/i30cw	1.4/1.6/1.6CRDi/2.0i/2.0CRDi		e11*2001/116*0313*, -/343*, e11*2007/46*0225*	FD/FDH	01.09-02.12	6 J x 16	205/55R16				16146	R1-1770	4250906817707	9617	HY516007	67	114,3	5	50	30	100,10	
i30/i30cw	1.4/1.4CRDi/1.6/1.6CRDi		e11*2007/46*0337*, -/338*, e13*2007/46*1604*	GDH/GDH-HME	03.12-01.17	6 1/2 J x 16	205/55R16				16176	R1-1853	4250906818537	9147	HY516011	67	114,3	5	51	30	107,70	
i30//Kombi	1.0T-GDI/1.4T-GDI/1.6CRDi		e11*2007/46*3807*, e5*2007/46*1075*	PDE	02.17-	6 J x 15	195/65R15				15294	R1-2010	4250906820103	4595	HY515022	67	114,3	5	46	40	90,60	
i30/Fastback/Kombi	1.0T-GDI/1.4T-GDI/1.5-GDI-Hybrid/1.6CRDi		e11*2007/46*3807*, e5*2007/46*1075*	PDE	02.17-	6 1/2 J x 16	205/55R16				16247	R1-2011	4250906820110	6595	HY516015	67	114,3	5	50	30	107,90	
ix35	1.6/1.6blue/1.7CRDi/2.0i/2.0CRDi/2WD/4WD		e11*2007/46*0104*, bis e11*2007/46*0192*05	EL/ELH	03.10-08.13	6 1/2 J x 16	215/70R16				16243	R1-1969	4250906819695	8756	HY516009	67	114,3	5	45	30	117,30	
ix35 (Facelift)	1.6/1.6blue/1.7CRDi/1.7CRDi-blue/2.0GDi/2.0CRDi		ab e11*2007/46*0192*06	ELH	09.13-12.15	6 1/2 J x 16	215/70R16				16210	R1-1926	4250906819268	8758	HY516012	67	114,3	5	48	30	112,30	
i40/i40cw/i40Space	1.6GDi/1.6CRDi/1.7CRDi/2.0GDi		e4*2007/46*0263*, -/264*	VF	07.11-	7 J x 16	205/60R16				16169	R1-1825	4250906818254	9317	HY516010	67	114,3	5	40	24	123,90	
Kona	1.0T-GDI/1.6T-GDI Hybrid/1.6-Gdi/1.6RDi-Hybrid/AWD		e4*2007/46*1259*	OS	10.17-	6 1/2 J x 16	205/60R16				16255	R1-2039	4250906820394	7001	HY516016	67	114,3	5	44	30	116,40	
Staria	2.2CRDi		e4*2018/858*00055*	US4	01.23-	6 1/2 J x 17	215/65R17				17047	R1-2130	4250906821308	9209		N	92,3	139,7	6	48	25	142,50
Sonata/Sonica	2.0/2.0CRDi/2.4/3.3-V6		e11*2001/116*0241*	NF	03.05-05.10	6 1/2 J x 16	215/60R16				16244	R1-1970	4250906819701	8755			67	114,3	5	46	30	139,60
Tucson	2WD/2.0/2.0-CRDi / 4WD/2.0/2.0-CRDi/2.7-V6		e4*2001/116*0087*	JM	07.04-02.10	6 1/2 J x 16	215/65R16				16244	R1-1970	4250906819701	8755			67	114,3	5	46	30	139,60
Tucson	1.6GDi/1.7CRDi/2.0CRDi	Nicht für Ausführungen mit elektr. Parkbremse und 17" Bremsanlage	e11*2007/46*2724*, e13*2007/46*1612*, e5*2007/46*1076*	TLE/TLE-HME	06.15-10.20	6 1/2 J x 16	215/70R16				16243	R1-1969	4250906819695	8756	HY516009	67	114,3	5	45	30	117,30	
Tucson	1.6T-GDI/1.6GDi-Hybrid		e5*2018/858*00001	NX4e	11.20-	7 J x 17	215/65R17				17045	R1-2111	4250906821117	9004			67	114,3	5	43,5	25	131,80

Hyundai Nfz.

H350	2.5CRDi		e9*2007/46*6265*, -/6429*	EU(V)/EU(V)-N2	06.15-	6 1/2 J x 16	235/65R16				16226	R1-1950	4250906819503	6503	HY616002	92,3	139,7	6	50	30	147,20
------	---------	--	---------------------------	----------------	--------	--------------	-----------	--	--	--	--------------	---------	---------------	------	----------	------	-------	---	----	----	---------------

Modell- bezeichnung	Motorvarianten	Bemerkungen	ABE-Nummer	Fahrzeugtyp	Bauzeit von/bis	Radab- messung	Reifengröße			MWD- Nr.	MW-AM Nr.	EAN-Nr.	Alcar- Nr.	KPZ- Nr.	Bemerk.	Anschlussmaße				Stk. p.Pal.	Preis in € exkl. MwSt.
Car model	Motorversion	General remarks	ABE-Number	Project Code	Production year	Wheel Size	Tyre Size			MWD- Ref.	MW-AM Ref.	EAN-Nr.	Alcar- Ref.	KPZ- Ref.	Remarks	Techn. Connection				Qty. p.Pal.	Price in € without TVA
															Center hole	Pitch circle diameter	Hole number	Offset in mm			

Iveco Nfz.

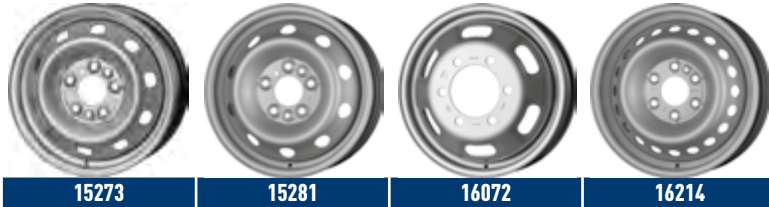

Daily S2000	29L9/29L.11/35S.9/35S.11/35S.13	Radlast 1.000 kg	K664	S1	07.99-12.13	6J x15	205/70R15	215/70R15	225/70R15	15273	R1-1908	4250906819084	4011	FL615007		71,1	118	5	68	40	108,90
Daily S2000	29L9/29L.11/35S.9/35S.11/35S.13	Radlast 1.000 kg	K664	S1	07.99-12.13	6J x15	205/70R15	215/70R15	225/70R15	15281	R1-1941	4250906819411	4012			71,1	118	5	68	40	108,90
Iveco Daily S2000	35C.9/35C.11/35C.13		K665	S2	01.90-12.99	5JK x16	185/75R16	195/65R16		16072	R1-1347	4250906813471	9485	IV616011		130	170	6	109	36	125,00
Iveco Daily/ DailyE6/DailyE6- Hi-Matic	35C-12/14/15/16/18/21; 40C-15/18/21 / 45C-15/18/21; 50C-15/18/21	Zwillingsbereifung - RDKS tauglich			01.14-	5 1/2 J x16	195/75R16			16285	R1-2044	4250906820448	6023	IV616015		130	170	6	107	30	138,60
Iveco Daily/ DailyE6/DailyE6- Hi-Matic	60C-18/21;65C-14N/15/18/21 / 70C-14G/15/18/21; 72C-15/18/21	Zwillingsbereifung			05.21-	6J x16	225/75R16			16292	R1-2105	4250906821056				161	205	6	124	36	146,10
Iveco Daily/ DailyE6/DailyE6- Hi-Matic	33S-12/14/16; 35S-12/14/14N/15/18/21/355-Flexbox		e1*2007/46*1933*	IS35512AA	01.14-	6 1/2 J x16	215/65R16	225/65R16	235/65R16	16214	R1-1913	4250906819138	6022	IV616013		74,1	125	6	68	30	152,30
Iveco Daily HEV	info				02.22-	6 1/2 J x16				16294	R1-2110	4250906821100				130	170	6	92	30	143,90



16213

16238

17016

Compass	1.4Multiair/1.6Multijet/2.0Multijet		e4*2007/46*1410*; e11*2007/46*4037*; e3*2007/46*0508*	MX/MP	04.17-	6½J x16	215/65R16			16213	R1-1918	4250906819183	8887	FL516008	65	110	5	40	30	105,40
Renegade	1.4/1.6TD/2.0TD	Stylingrad	e3*2007/46*0300*	BU	10.14-	6½J x16	215/65R16			16238	R1-1962	4250906819626			65	110	5	40	30	127,50
Renegade	1.4/1.6TD/2.0TD+D211	runde Ventilationslöcher	e3*2007/46*0300*	BU	10.14-	6½J x16	215/65R16			16213	R1-1918	4250906819183	8887	FL516008	65	110	5	40	30	105,40
Renegade	1.4/1.6TD/2.0TD		e3*2007/46*0300*	BU	10.14-	6½J x17	215/60R17			17016	R1-1944	4250906819442			65	110	5	40	25	105,90

Picanto	1.1i/1.1CRDi		e4*2001/116*0085*	BA	04.04-04.11	5 J x14	165/60R14	175/60R14			14158	R1-1571	4250906815710	5490	KI514004	54	100	4	46	54	101,40
Picanto II	1.0/1.0LPG/1.2		bis e4*2007/46*0256*08	TA	05.11-04.17	4,00B x13	155/70R13				13116	R1-1572	4250906815727	2490	KI513003	54	100	4	46	72	91,20
Picanto II	1.0/1.0LPG/1.2		e4*2007/46*0256*	TA	05.11-04.17	5 J x14	165/60R14				14189	R1-1819	4250906818193	5965	KI514006	54	100	4	49	54	101,20
Picanto III	1.0/1.2		e11*2007/46*3848*, e5*2007/46*1078*	JA	06.17-	5 1/2 J x14	175/65R14				14206	R1-2032	4250906820325	3635	KI514007	54	100	4	45	54	100,60
Rio III	1.1CRDi/1.2CVT/1.4CRDi/1.4CVT		e11*2007/46*0195*	UB	09.11-01.17	5 1/2 J x15	185/65R15				15246	R1-1828	4250906818285	7530	KI515010	54	100	4	36	48	104,60
Rio IV	1.0T-GDI/1.2/1.4/1.4CRDi/1.6CRDi	Nicht zulässig bei Fahrzeugen mit elektrischer Feststellbremse	e11*2007/46*3777*, e5*2007/46*1077*	YB	02.17-	6 J x15	185/65R15				15296	R1-2002	4250906820028	4065	KI515011	54	100	4	46	40	97,70
Sephia II	1.5SLX/1.6SLX/GTX/1.8i		G485, e13*95/54*0021*, e13*96/27*0021*	FA	10.95-04.98	5 1/2 J x14	185/60R14				14108	R1-1354	4250906813549	7220	KI514001	56	100	4	45	48	99,00
Shuma I	1.5i-LS/RS/1.8i-GS/LS/RS		e4*96/27*0024*, e4*98/14*0024*	FB	05.98-03.01	5 1/2 J x14	185/65R14				14108	R1-1354	4250906813549	7220	KI514001	56	100	4	45	48	99,00
Shuma II	1.6i-LS/RS/1.8i-LS/RS		e4*98/14*0024*	FB	04.01-04.04	5 1/2 J x14	185/65R14	195/60R14			14108	R1-1354	4250906813549	7220	KI514001	56	100	4	45	48	99,00
Soul	1.6CVT/1.6CRDi		e4*2001/116*0139*, e4*2007/46*0133*	AM	04.09-04.14	6 J x15	195/65R15				15226	R1-1751	4250906817516	7610	KI515008	67	114,3	5	44	40	90,90
Soul II	1.6CRDi/1.6GDI/2.0GDI/Electro EV (81kW)		e4*2007/46*0825*, e9*2007/46*6160*	PS/PSEV	04.14-03.19	6 1/2 J x16	205/60R16				16216	R1-1927	4250906819275	8787	KI516007	67	114,3	5	47	30	117,70
e-Soul	Elektro (100/150kW)		e4*2007/46*1365*	SK3	04.19-	7 J x17	215/55R17				17026	R1-2036	4250906820363	9012	MA517002	67	114,3	5	50	25	129,90
Sportage II	2.0CVT/2.0CRDi/2-WD 2.0CVT/2.0CRDi/2.7V6/4-WD		e4*2001/116*0089*, e4*2001/116*0120*	JE/JES	12.04-04.10	6 1/2 J x16	215/65R16				16244	R1-1970	4250906819701	8755		67	114,3	5	46	30	139,60
Sportage III	1.7CRDi/2.0/2.0CRDi/2WD/4WD	Modelle aus Slowakien	bis e11*2007/46*0136*09	SLS	05.10-03.14	6 1/2 J x16	215/70R16				16167	R1-1821	4250906818216	8987	KI516004	67	114,3	5	31,5	30	123,90
Sportage III	2.0/2.0CRDi/2WD/4WD	Modelle aus Südkorea	e11*2007/46*0166*	SL	07.10-03.14	6 1/2 J x16	215/65R16	215/70R16	225/65R16		16167	R1-1821	4250906818216	8987	KI516004	67	114,3	5	31,5	30	123,90
Sportage III (Facelift)	1.6GDI/1.7CRDi/2.0CRDi/2.0CRDi-184/2.0GDI/2.0CVT/2WD/4WD	Modelle aus Slowakien	ab e11*2007/46*0136*10	SLS	04.14-01.16	6 1/2 J x16	215/70R16				16217	R1-1928	4250906819282	8837	KI516008	67	114,3	5	36	30	117,30
Sportage IV	1.6GDI/1.6T-GDI/1.7CRDi/2.0CRDi/2WD/4WD		e11*2007/46*3144*, e5*2007/46*1081*	QLE	02.16-	6 1/2 J x16	215/70R16				16235	R1-1978	4250906819787	6655	KI516009	67	114,3	5	42,5	30	108,10
Sportage IV	1.6GDI/1.6T-GDI/1.7CRDi/2.0CRDi/2.4GDI/2WD/4WD		e11*2007/46*3144*, -/3139*, e5*2007/46*1081*	QLE/QL	02.16-	7 J x17	225/60R17				17024	R1-2017	4250906820172	8266	KI517001	67	114,3	5	48,5	25	141,50
Sportage V	1.6TCI/1.6T-GDI/2.0MPI		e4*2018/858*00079*	NQ5e	02.22-	7 J x17	215/65R17				17045	R1-2111	4250906821117	9104		67	114,3	5	43,5	25	131,80
Stonic	1.0T-GDI/1.2/1.4/1.6CRDi		e11*2007/46*3777*, e5*2007/46*1077*, e1*2007/46*2094*	YB/YB-KMD	10.17-	6 J x15	185/65R15				15296	R1-2002	4250906820028	4065	KI515011	54	100	4	46	40	97,70
Venga	1.4CVT/1.4CRDi-75/90/1.6CVT/1.6CRDi-115/128	RDKS	e4*2007/46*0130*, -/0131*, -/261*, -/262*	YN/YNS	01.10-05.19	6 J x15	195/65R15				15279	R1-1914	4250906819145	6505	KI515009	67	114,3	5	48	48	99,90

Modell- bezeichnung	Motorvarianten	Bemerkungen	ABE-Nummer	Fahrzeugtyp	Bauzeit von/bis	Radab- messung	Reifengröße		MWD- Nr.	MW-AM Nr.	EAN-Nr.	Alcar- Nr.	KPZ- Nr.	Bemerk.	Anschlussmaße				Stk.	Preis in €
Car model	Motorversion	General remarks	ABE-Number	Project Code	Production year	Wheel Size	Tyre Size		MWD- Ref.	MW-AM Ref.	EAN-Nr.	Alcar- Ref.	KPZ- Ref.	Remarks	Techn. Connection				Qty.	Price in €
															Center hole	Pitch circle diameter	Hole number	Offset in mm	p.Pal.	exkl. MwSt.

Lancia



Musa	1.3D-Multijet-16V/1.4-8V/1.4-16V		e3*2001/116*0153*	350 (Lancia)	01.05-12.12	6J x14	185/65R14			14172	R1-1638	4250906816380	6875	FL514023	58	98	4	40	45	90,80
Musa	1.3D-Multijet-16V/1.4-8V/1.4-16V/1.6D-Multijet-16V/1.9D-Multijet-8V		e3*2001/116*0153*	350 (Lancia)	01.05-12.12	6J x15	195/60R15			15159	R1-1475	4250906814751	8185	FL515009	58	98	4	40	48	99,00
Phedra	2.0JTD-16V/2.2JTD-16V/3.0 V6-24V		e2*98/14*0255*	179	06.04-08.10	7J x16	215/60R16			16050	R1-1470	4250906814706			58	98	5	27	30	114,70
Ypsilon	1.2-8V/1.3D-Multijet/1.3D-Multijet-DF-N/1.4-8V/1.4-16V		e3*2001/116*0149*	843	10.03-05.11	6J x14	185/65R14			14172	R1-1638	4250906816380	6875	FL514023	58	98	4	40	45	90,80
Ypsilon	1.2-8V/1.3D-Multijet/1.3D-Multijet-DF-N/1.4-8V/1.4-16V		e3*2001/116*0149*	843	10.03-05.11	6J x15	195/55R15			15159	R1-1475	4250906814751	8185	FL515009	58	98	4	40	48	99,00
Ypsilon	0.9-8V/1.2-8V/1.3-Multijet-16V		e3*2007/46*0064*	312	06.11-12.17	6J x15	185/55R15	195/50R15		15244	R1-1804	4250906818049	8753	FL515021	58	98	4	30	48	104,90

Land Rover



Freelander II	2.2D-TD4		e11*2001/116*0300*	LF	12.06-01.15	6 1/2J x16	215/75R16			16084	R1-1645	4250906816458	8465	F0516007	63,3	108	5	50	30	103,90
---------------	----------	--	--------------------	----	-------------	------------	-----------	--	--	--------------	---------	---------------	------	----------	------	-----	---	----	----	---------------

MAN Nfz.



16249

16250

16271

TGE 3.0/3.5/E-TGE	2.0D/4x4/E-TGE (100kW)	205/75R16 nur Frontantrieb bis 3.5t Radlast 1.050 kg	e1*2007/46*1626*, -/1632*	SYN1E/SZN1E	07.17-	6 1/2 J x 16	205/75R16	235/65R16			16250	R1-2016	4250906820165	6695	VO616031	65,1	120	5	60	30	120,30
TGE 3.5/E-TGE	2.0D/4x4/E-TGE (100kW)	nur Heckantrieb über 3.5t Radlast 1.200 kg	e1*2007/46*1626*, -/1627* -/1632*, -/1633*	SYN1E/SYN2E/SYN1E/SZN2E	07.17-	6 1/2 J x 16	235/65R16				16271	R1-2053	4250906820530	6696	VO616029	65,1	120	5	60	30	135,90
TGE 3.5/5.0	2.0D/4x4	Zwillingsbereifung auch für Vorderachse	e1*2007/46*1628*, -/1629*, -/1634*, -/1635*	SYN1Z/SYN2Z/SZN1Z/SZN2Z	07.17-	5 1/2 J x 16	205/75R16				16249	R1-2015	4250906820158	6685	VO616030	161	205	6	HMA 121,5	30	190,10

Modell- bezeichnung	Motorvarianten	Bemerkungen	ABE-Nummer	Fahrzeugtyp	Bauzeit von/bis	Radab- messung	Reifengröße		MWD- Nr.	MW-AM Nr.	EAN-Nr.	Alcar- Nr.	KPZ- Nr.	Bemerk.	Anschlussmaße				Stk. p.Pal.	Preis in € exkl. MwSt.
Car model	Motorversion	General remarks	ABE-Number	Project Code	Production year	Wheel Size	Tyre Size		MWD- Ref.	MW-AM Ref.	EAN-Nr.	Alcar- Ref.	KPZ- Ref.	Remarks	Techn. Connection		Qty. p.Pal.	Price in € without TVA		
															Center hole	Pitch circle diameter	Hole number	Offset in mm		

Mazda

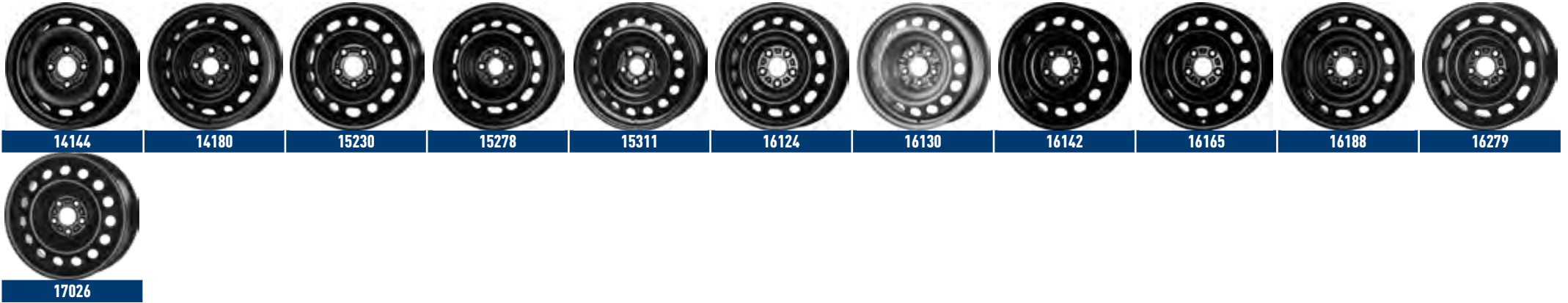

CX-3	Skyactiv-G 105/120/150/FWD/AWD / Skyactiv-D 105/FWD/AWD		e1*2007/46*1335*	DJ1	07.15-	6 1/2 J x 16	215/60R16				16188	R1-1883	4250906818834	9062	MA516007	67	114,3	5	50	30	119,80
CX-30	Skyactiv-D 1.8/Skyactiv-G 2.0 Hybrid/-150/Skyactiv-X 2.0M Hybrid	nicht geeignet für Allradversion	e13*2007/46*2041*	DM	09.19-	6 1/2 J x 16	215/65R16				16279	R1-2080	4250906820806	7063		67	114,3	5	45	30	119,80
CX-5 II	Skyactiv-G 160/165/192/194/FWD/AWD / Skyactiv-D 150/175/FWD/AWD		e13*2007/46*1803*	KF	05.17-	7 J x 17	225/65R17				17026	R1-2036	4250906820363	9012	MA517002	67	114,3	5	50	25	129,90
Mazda 2	1.25-MZI/1.4-MZI/1.4MZ-CD/1.6-MZI		e1*2001/116*0212*	DY	04.03-09.07	5 1/2 J x 14	175/65R14				14144	R1-1464	4250906814645	6275	F0514010	63,3	108	4	47,5	54	82,10
Mazda 2	1.3-MZR/1.4MZ-D/1.5MZ-i		e13*2001/116*0254* ,-/255*, e13*2007/46*1070*	DE/DE1/DEE	10.07-01.15	6 J x 14	175/65R14	185/60R14			14180	R1-1720	4250906817202	5270	MA514009	54	100	4	45	40	104,50
Mazda 2	Skyactiv-G75(1.5)/G90(1.5)/G105(1.5D)		e1*2007/46*1335*	DJ1	02.15-	5 1/2 J x 15	185/65R15				15278	R1-1929	4250906819299	7225	MA515014	54	100	4	40	40	108,50
Mazda 2 Hybrid	1.5 Hybrid		e6*2018/858*00149*	ZV	01.22-	6 J x 15	185/65R15				15311	R1-2096	4250906820967	7616		54	100	5	45	48	105,90
Mazda 3	1.6MZR/1.6MZ-CD		bis e11*2001/116*0262*09	BL	04.09-09.13	6 J x 15	195/65R15	205/60R15			15230	R1-1766	4250906817660	7223	MA515012	67	114,3	5	50	40	108,50
Mazda 3	1.6MZR/1.6MZ-CD/2.0MZR/2.0MZR-DISI/2.2MZR-CD		bis e11*2001/116*0262*09	BL	04.09-09.13	6 1/2 J x 16	205/55R16				16142	R1-1767	4250906817677	9223		67	114,3	5	50	30	119,80
Mazda 3	Skyactiv-D105/D150/G100/G120/G165		ab e11*2001/116*0262*10	BL	10.13-02.19	6 1/2 J x 16	205/60R16				16188	R1-1883	4250906818834	9062	MA516007	67	114,3	5	50	30	119,80
Mazda 3	Skyactiv-D 1.8/Skyactiv-G 2.0 M		e13*2007/46*1972*, e13*2007/46*2249*	BP/BPE	03.19-	6 1/2 J x 16	205/60R16				16279	R1-2080	4250906820806	7063		67	114,3	5	45	30	119,80
Mazda 5	1.8-MZR/2.0-MZR/2.0-MZR-CD		e13*2001/116*0156*	CR1	08.05-09.10	6 1/2 J x 16	205/55R16				16130	R1-1748	4250906817486	9645	MA516002	67	114,3	5	50	30	146,20
Mazda 5	1.6MZR/1.6MZ-CD/1.8MZR/2.0MZR-DISI		e1*2007/46*0433*	CW	10.10-12.15	6 1/2 J x 16	205/55R16				16165	R1-1818	4250906818186	8763		67	114,3	5	52,5	30	119,70
Mazda 6/Sport	1.8MZR/2.0-MZR/2.0-MZR-CD/2.3-MZR/4x4		e1*98/14*0188*	GG/GY	09.02-06.05	6 J x 15	195/65R15				15145	R1-1507	4250906815079	8735	MA515006	67	114,3	5	50	88	120,90

Mazda 6 (Facelift)	1.8MZR/2.0MZR/2.0MZR-CD	e11*2001/116*0203*	GG1	07.05-01.08	6JJ x15	195/65R15			15145	R1-1507	4250906815079	8735	MA515006	67	114,3	5	50	88	120,90
Mazda 6	1.8-MZR/2.0-MZR/2.0-MZR-CD/2.2-MZR-CD/2.5-MZR	bis e1*2001/116*0448*13, e13*2007/46*1075*	GH/GHE	02.08-11.12	6J x16	195/65R16	205/60R16		16124	R1-1722	4250906817226	9532	MA516004	67	114,3	5	50	30	121,60
MPV	2.0-MZR-CD	e1*98*/14*0118*	LW	09.02-12.05	6½J x16	215/60R16			16130	R1-1748	4250906817486	9645	MA516002	67	114,3	5	50	30	146,20
Tribute	2.0i-2WD/2.0i-4WD	e4*98/14*0044*, e13*2001/116*0092*	EP/EP2	09.01-12.06	6½J x16	215/70R16			16130	R1-1748	4250906817486	9645	MA516002	67	114,3	5	50	30	146,20

Modell- bezeichnung	Motorvarianten	Bemerkungen	ABE-Nummer	Fahrzeugtyp	Bauzeit von/bis	Radab- messung	Reifengröße			MWD- Nr.	MW-AM Nr.	EAN-Nr.	Alcar- Nr.	KPZ- Nr.	Bemerk.	Anschlussmaße				Stk. p.Pal.	Preis in € exkl. MwSt.
Car model	Motorversion	General remarks	ABE-Number	Project Code	Production year	Wheel Size	Tyre Size			MWD- Ref.	MW-AM Ref.	EAN-Nr.	Alcar- Ref.	KPZ- Ref.	Remarks	Techn. Connection		Hole number	Offset in mm	Qty. p.Pal.	Price in € without TVA

Mercedes

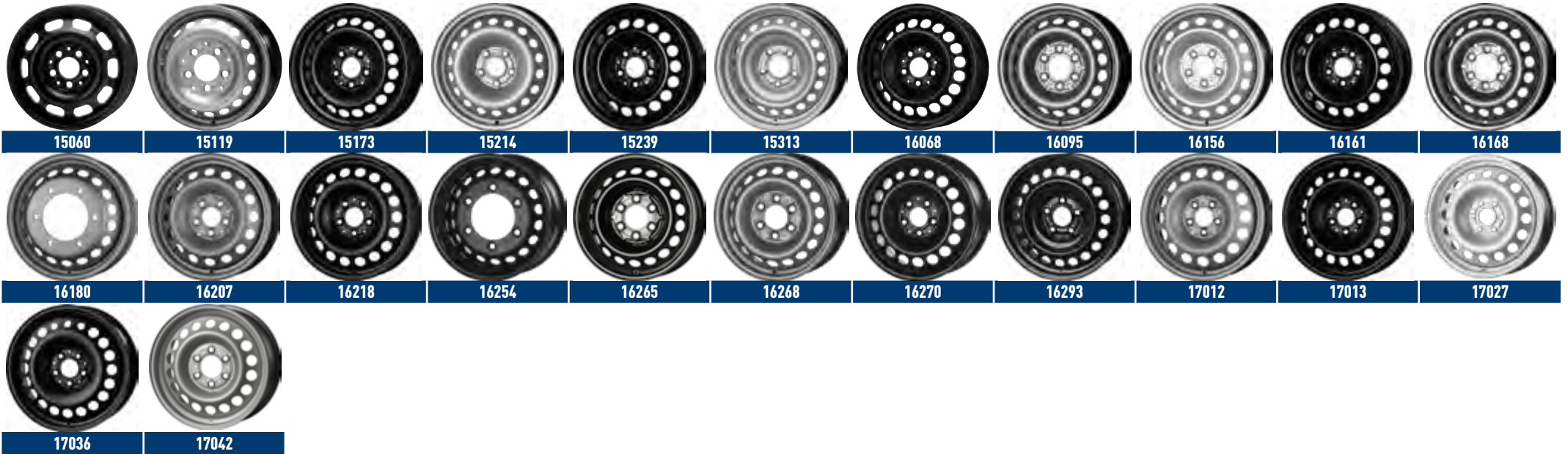

A-Klasse/A-Klasse-L	A140/A160/A160CDI/A170CDI/A140L/A160L/A170CDI-L		e1*96/79*0073*	168	10.97-09.04	5 1/2 J x 15	175/65R15	185/55R15	195/50R15	15060	R1-1275	4250906812757	8220	ME515036		66,5	112	5	54	40	89,90
A-Klasse	A150/A160CDI/A170/A180CDI		e1*2001/116*0288*	169	10.04-08.12	6 J x 15	185/65R15			15173	R1-1567	4250906815673	8245	ME515049		66,5	112	5	44	48	96,20
A-Klasse	A150/A160CDI/A170/A180CDI/A200/A200CDI/A200-Turbo		e1*2001/116*0288*	169	10.04-08.12	6 J x 16	195/55R16			16068	R1-1576	4250906815765	8595	ME516017		66,5	112	5	46	48	108,60
A-Klasse	160CDI/180/180CDI/180CDI-7G-DCT		e1*2007/46*0928*, e1*2001/116*0470*	176/245G	09.12-05.18	6 1/2 J x 15	195/65R15			15239	R1-1813	4250906818131	7620	ME515052		66,5	112	5	47	40	93,50
A-Klasse	160CDI/180/180CDI/180CDI-7G-DCT/200/200CDI/220C-DI/4-matic		e1*2007/46*0928*, e1*2001/116*0470*	176/245G	09.12-05.18	6 1/2 J x 16	205/55R16			16161	R1-1812	4250906818124	9732	ME516025		66,5	112	5	49	30	95,60
A-Klasse/ Limousine (W177)	A160/A160d/A180/A180d/A200/A200d / Limousine A160d/A180d/A200	nicht AMG Ausführung, nicht für Sportbremse geeignet	e1*2007/46*1829*	F2A	06.18-	6 1/2 J x 16	205/60R16			16270	R1-2048	4250906820486	7732	ME516028		66,5	112	5	44	30	111,20
A-Klasse/ Limousine (W177)	A160/A160d/A180/A180d/A200/A200d/A220/A220d/A250/4-matic / Limousine A160d/A180d/A200/A220/A250/4-matic	nicht AMG Ausführung, nicht für Sportbremse geeignet	e1*2007/46*1829*	F2A	06.18-	6 1/2 J x 17	205/55R17			17036	R1-2049	4250906820493	9832			66,5	112	5	44	25	121,10
B-Klasse	150/170		e1*2001/116*0314*	245	05.05-10.11	6 J x 15	195/65R15			15173	R1-1567	4250906815673	8245	ME515049		66,5	112	5	44	48	96,20
B-Klasse	150/170/170NGT/180CDI/200/200CDI/200-Turbo		e1*2001/116*0314*, -/470*	245/245G	05.05-10.11	6 J x 16	205/55R16			16068	R1-1576	4250906815765	8595	ME516017		66,5	112	5	46	48	108,60

B-Klasse	160CDI/180/180CDI		e1*2007/46*0751*, e1*2001/116*0470*	246/245G	11.11-01.19	6½J x15	195/65R15			15239	R1-1813	4250906818131	7620	ME515052	66,5	112	5	47	40	93,50
B-Klasse	160CDI/180/180CDI/200/200CDI/220CDI/4-matic		e1*2007/46*0751*, e1*2001/116*0470*	246/245G	11.11-01.19	6½J x16	205/55R16			16161	R1-1812	4250906818124	9732	ME516025	66,5	112	5	49	30	95,60
B-Klasse (W247)	B160/B160d/B180/B180d/B200/B200d	nicht AMG Ausführung, nicht für Sportbremse geeignet	e1*2007/46*1909*	F2B	02.19-	6½J x16	205/60R16			16270	R1-2048	4250906820486	7732	ME516028	66,5	112	5	44	30	111,20
B-Klasse (W247)	B160/B160d/B180/B180d/B200/B200d/B220d/B250/4-matic	nicht AMG Ausführung, nicht für Sportbremse geeignet	e1*2007/46*1909*	F2B	02.19-	6½ J x17	205/55R17			17036	R1-2049	4250906820493	9832		66,5	112	5	44	25	121,10
C-Klasse	180/200/200K/200CDI/220CDI/240/250TD/280		e1*92/53*0001*, e1*93/81*0034*	H0/202	09.95-04.00	7 J x16	205/55R16			16028	R1-1198	4250906811989	9890	ME516008	66,5	112	5	37	24	117,50
C-Klasse/ Sportcoupé	180/180K/200CDI/200CGI/200K/220C-DI/230K/240/270CDI/280/320/4-matic / Sportcoupé 180/180K/200CDI/200CGI/220CDI/230K/320		e1*98/14*0139*, -/158*, -/159*	203/203K/203CL	05.00-02.07	7 J x16	205/55R16	225/50R16		16028	R1-1198	4250906811989	9890	ME516008	66,5	112	5	37	24	117,50
C-Klasse	180K/180CGI/180CDI/200CDI/220CDI		bis e1*2001/116*0431*28	204	07.07-08.14	6 J x16	195/60R16			16102	R1-1696	4250906816960	8597	ME516022	66,5	112	5	39	40	101,20
C-Klasse Coupé	180		bis e1*2001/116*0431*32	204	01.12-10.15	6 J x16	195/60R16			16102	R1-1696	4250906816960	8597	ME516022	66,5	112	5	39	40	101,20
C-Klasse (W205)	C160/C180/C200	nur für Limousine	ab e1*2001/116*0431*29	204	04.14-	6 J x16	195/65R16			16218	R1-1919	4250906819190	8952	ME516026	66,5	112	5	36	30	92,20
CLA Klasse	CLA 180/CLA 180 Blue Efficiency/CLA 200/CLA-220CDI/4-matic		e1*2007/46*1007*, e1*2001/116*0470*	117/245G	04.13-03.19	6½J x16	205/55R16			16161	R1-1812	4250906818124	9732	ME516025	66,5	112	5	49	30	95,60
CLA-Klasse (W118)	CLA-180/CLA-180d/CLA-200	nicht AMG Ausführung, nicht für Sportbremse geeignet	e1*2007/46*1912*	F2CLA	04.19-	6½J x16	205/60R16			16270	R1-2048	4250906820486	7732	ME516028	66,5	112	5	44	30	111,20
CLA-Klasse (W118)	CLA-180/CLA-180d/CLA-200/CLA-220/CLA-250/4-matic	nicht AMG Ausführung, nicht für Sportbremse geeignet	e1*2007/46*1912*	F2CLA	04.19-	6½ J x17	205/55R17			17036	R1-2049	4250906820493	9832		66,5	112	5	44	25	121,10
CLC Sportcoupé (Facelift)	160/180K/200K/200CDI/220CDI/250		ab e1*98/14*0159*19	203CL	05.08-02.11	7 J x16	205/55R16			16028	R1-1198	4250906811989	9890	ME516008	66,5	112	5	37	24	117,50
CLK	Coupé 200/230K/320/Cabrio 200K/230K/320		e1*96/27*0054*	208	06.97-04.02	7 J x16	205/55R16			16028	R1-1198	4250906811989	9890	ME516008	66,5	112	5	37	24	117,50
CLK	Coupé 200K/200CGI-K/220CDI/240/270CDI/280/320 Cabrio 200K/200CGI/240/280/320		e1*98/14*0184*	209	05.02-03.10	7 J x16	205/55R16			16028	R1-1198	4250906811989	9890	ME516008	66,5	112	5	37	24	117,50
GLA	180/180CDI/200/200CDI/220CDI/250/4-matic		e1*2001/116*0470*	245G	01.14-05.20	6½J x17	215/60R17			17013	R1-1920	4250906819206	9787	ME517006	66,5	112	5	38	25	129,80
GLA II	180/180d/200d/220d/220e/250/250e/4-matic		ab e1*2007/46*1909*06	F2B	06.20-	7 J x17	215/65R17			17040	R1-2086	4250906820868	9788		66,5	112	5	44	25	133,40
GLB	180/180d/200/200d/220d/250/4-matic		ab e1*2007/46*1909*03	F2B	12.19-	7 J x17	215/65R17			17040	R1-2086	4250906820868	9788		66,5	112	5	44	25	133,40
T-Klasse	T160/T160d/T180/T180d				08.22-	6 J x16	205/60R16			16293	R1-2112	4250906821124	6516		66	114,3	5	38	30	109,60
V-Klasse/Marco Polo (W447)	V160d/V180d/V200d/V220d/V250d		ab e1*2007/46*0457*09, ab e1*2007/46*0458*08	639-2/639-4	06.14-	6½J x16	195/65R16	205/65R16	225/60R16	16207	R1-1911	4250906819114	6501	ME516027	66,5	112	5	52	30	128,10
V-Klasse/Marco Polo (W447)	V160d/V180d/V200d/V220d/V250d/V250d/V300d/4-matic		ab e1*2007/46*0457*09, ab e1*2007/46*0458*08	639-2/639-4	06.14-	6½J x17	225/55R17	235/55R17		17012	R1-1912	4250906819121	9002	ME517007	66,5	112	5	50	25	149,20
Viano	2.0CDI/2.2CDI/3.0CDI/3.0i/3.2i/3.5i		e9*2001/116*0048*	639	08.03-09.10	6½J x16	205/65R16	225/60R16		16156	R1-1793	4250906817936	9897	ME616017	66,5	112	5	60	30	146,40
Viano II (Facelift)	CDI-2.0/CDI2.2/CDI3.0		bis e1*2007/46*0457*08	639/2	10.10-05.14	6½J x16	205/65R16	225/60R16		16156	R1-1793	4250906817936	9897	ME616017	66,5	112	5	60	30	146,40

Modell- bezeichnung	Motorvarianten	Bemerkungen	ABE-Nummer	Fahrzeugtyp	Bauzeit von/bis	Radab- messung	Reifengröße			MWD- Nr.	MW-AM Nr.	EAN-Nr.	Alcar- Nr.	KPZ- Nr.	Bemerk.	Anschlussmaße				Stk. p.Pal.	Preis in € exkl. MwSt.	
Car model	Motorversion	General remarks	ABE-Number	Project Code	Production year	Wheel Size	Tyre Size			MWD- Ref.	MW-AM Ref.	EAN-Nr.	Alcar- Ref.	KPZ- Ref.	Remarks	Techn. Connection				Qty. p.Pal.	Price in € without TVA	
															Center hole	Pitch circle diameter	Hole number	Offset in mm				

Mercedes Nfz.

Citan/Tourer	108CDI/109CDI/111CDI/112/115CDI		e2*2007/46*0129*, e2*2007/46*0130*	X	10.12-	6 J x15	195/65R15				15214	R1-1712	4250906817127	7215	RE515023		60	108	5	44	40	101,70
Citan II/Citan II Tourer	110/110CDI/113		e2*2018/858*00014*, -/15*	MFK	10.21-	6 J x15	195/65R15				15313	R1-2099	4250906820998	4517			66	114,3	5	35	40	99,70
Citan II/Citan II Tourer	108/110/113/108CI/110CDI/112CDI		e2*2018/858*00014*, 00015*	MFK	10.21-	6 J x16	205/60R16				16293	R1-2112	4250906821124	6516			66	114,3	5	38	30	109,60
Sprinter I	208CDI/211CDI/213/213CDI/216CDI/308CDI/310C- DI/311CDI/312CDI/313CDI/314/316CDI/4x4		e1*98/14*0060*, -/21*, -/127*, -/128*, e1*2001/116*0127*, -/128*, K416, K471, K487, K623, K624, K627, K641, K642, K628, K719	A/B/C/D/902.6KA/903JC/ 903.6/903.6-KA/903.6- P7903-4x4/903-4x4-KA	01.00-03.06	6 J x15	195/70R15	225/70R15			15119	R1-1404	4250906814041	8555	ME615016		84	130	5	75	40	124,10
Sprinter II	209CDI/210CDI/211CDI/213CDI/215CDI/216/216C- DI/218CDI/219CDI/224	zulässig bis 3.0t Gesamtgewicht	e1*2001/116*0353*, L763, L765	906-AC30/KA30/OK30	04.06-04.11	6 1/2 J x16	205/75R16	225/75R16	235/65R16		16095	R1-1647	4250906816472	9488	ME616013		84	130	6	62	30	122,10
Sprinter II	209CDI/210CDI/211CDI/213CDI/215CDI/216/216C- DI/218CDI/219CDI/224 / 309CDI/310CDI/311CDI/313C- DI/315CDI/316/316CDI/316NGT/LGT/318CDI/319CDI/324	zulässig bis 3.5t Gesamtgewicht	e1*2001/116*0354*, -/424*, e1*2007/46*0569*, L764, L766, L969, L970	906-AC35/AC35G/AC35-4x4/ KA35/KA35-4x4/OK35/ OK35-4x4	04.06-04.11	6 1/2 J x16	225/75R16	235/65R16			16095	R1-1647	4250906816472	9488	ME616013		84	130	6	62	30	122,10
Sprinter II (Facelift)	210CDI/213CDI/216/216CDI/219CDI/224	zulässig bis 3.0t Gesamtgewicht	e1*2007/46*0279*, -/280*	906BA30/906BB30	05.11-12.18	6 1/2 J x16	205/75R16	225/75R16	235/65R16		16095	R1-1647	4250906816472	9488	ME616013		84	130	6	62	30	122,10
Sprinter II (Facelift)	310CDI/311CDI/313CDI/314CDI/316/316LGT/316C- DI/316LGT/316NGT/319CDI/324	zulässig bis 3.5t Gesamtgewicht	bis e1*2007/46*0300*, bis -/301*15, bis -/354*20, -/556*, -/569*, /557*	906AC35/906AC35G/ 906BA35/906BB35/ 906BA35G/906BB35G	05.11-12.18	6 1/2 J x16	225/75R16	235/65R16			16095	R1-1647	4250906816472	9488	ME616013		84	130	6	62	30	122,10
Sprinter II (Facelift)	413CDI/416CDI/419CDI/424/511CDI/514CDI/516/516C- DI/516NGT/519CDI/524	Zwillingsbereifung ersetzt 16100	bis e1*2007/46*0294*08, -/295*, -/299*, bis -/304*05, -/307*, bis -/308*05, -/311*	906BA50/906BB50	05.11-12.18	5 1/2 J x16	195/75R16	205/75R16			16180	R1-1859	4250906818599	7870	ME616036		161	205	6	HMA 117	30	175,00
Sprinter II 4x4 (Facelift)	310CDI/311CDI/313CDI/314CDI/316/316C- DI/316LGT/316NGT/319CDI/324	zulässig bis 3.5t Gesamtgewicht	bis e1*2001/116*0424*14, e1*2007/46*0309*, bis -/312*11, bis -/305*10, -/310*	906AC35-4x4/906BA35- 4x4/906BB35-4x4	05.11-12.18	6 1/2 J x16	225/75R16				16095	R1-1647	4250906816472	9488	ME616013		84	130	6	62	30	122,10
Sprinter II 4x4 (Facelift)	511CDI/514CDI/516/516CDI/516NGT/519CDI	Zwillingsbereifung	bis e1*2007/46*0304*05, bis e1*2007/46*0308*05	906BA50-4x4/906BB50-4x4	05.11-12.18	5 1/2 J x16	205/75R16				16180	R1-1859	4250906818599	7870	ME616036		161	205	6	HMA 117	30	175,00
Sprinter II	210CDI/213CDI/216CDI/219BueTEC/216		e1*2001/116*0353*, L763, L765	906AC30	05.06-05.18	5 1/2 J x16	205/75R16				16168	R1-1673	4250906816731		ME616037		84	130	6	51	30	119,20
Sprinter II (W906)	413CDI/414CDI/416/416CDI/419CDI/426/513CDI/514C- DI/516/516CDI/519CDI/526/313CDI/314CDI/316/ 316CI/319CDI/326		e1*2007/46*0294*, - 295*, - 296*, -299*	906BA50/906BB50	06.18-	8 1/2 J x16	285/65R16				16254	R1-2033	4250906820332				161	205	6	63	24	248,10
Sprinter III FWD (W910)	211CDI/214CDI/311CDI/314CDI/411CDI/414CDI/Elektro (70kW)	Frontantrieb	e1*2007/46*1760*, -/1761*, -/1762*, -/1763*	KL3A4/FL3A4/KL3A5/FL3A5	03.18-	6 1/2 J x16	225/65R16	225/75R16			16268	R1-2050	4250906820509	7488	ME616013		84	130	6	62	36	118,50
Sprinter III RWD (W907)	311CDI/314CDI/316CDI/319CDI/411CDI/414CDI/416C- DI/419CDI	Heckantrieb	ab e1*2001/116*0354*21, ab e1*2007/46*0300*14, ab e1*2007/46*0294*09, ab e1*2007/46*0296*09, ab e1*2007/46*0301*16	906AC35/906BA35/906BA50/ 906BB35/906BB50	03.18-	6 1/2 J x16	225/65R16	225/75R16	235/65R16		16265	R1-2051	4250906820516	6131	ME616027		84	130	6	54	36	121,90
Sprinter III RWD (W907)	511CDI/514CDI/516CDI/519CDI	Zwillingsbereifung	ab e1*2007/46*0300*14, ab e1*2007/46*0294*09, ab e1*2007/46*0301*16, ab e1*2007/46*0296*09	906BA35/906BA50/ 906BB35/906BB50	03.18-	5 1/2 J x16	195/75R16	205/75R16			16180	R1-1859	4250906818599	7870	ME616036		161	205	6	HMA 117	30	175,00

Sprinter III 4x4 (W907)	311CDI/314CDI/316CDI/319CDI/411CDI/414CDI/416C-DI/419CDI		ab e1*2001/116*0424*15, ab e1*2007/46*0305*11, ab e1*2007/46*0308*06, ab e1*2007/46*0304*06, ab e1*2007/46*0312*12	906AC35-4x4/906BA35-4x4/906BB35-4x4/906BA50-4x4/906BB50-4x4	05.18-	6 1/2 J x 16	225/75R16				16265	R1-2051	4250906820516	6131	ME616027	84	130	6	54	36	121,90
Sprinter III 4x4 (W907)	511CDI/514CDI/516CDI/519CDI	Zwillingbereifung	ab e1*2007/46*0312*12, ab e1*2007/46*0305*11, ab e1*2007/46*0308*06, ab e1*2007/46*0304*06	906BA35-4x4/906BB35-4x4/906BA50-4x4/906BB50-4x4	05.18-	5 1/2 J x 16	205/75R16				16180	R1-1859	4250906818599	7870	ME616036	161	205	6	HMA 117	30	175,00
Sprinter III (W907)	311CDI/314CDI/316CDI/319CDI		e1*2001/116*0354*	906AC35	02.20-	7 J x 17	245/65R17				17042	R1-2093	4250906820936			84	130	6	50	30	148,90
Vito II	109CDI/111CDI/111CDI-4x4/115CDI/115C-DI-4x4/119/120CDI/122/123/126		e9*2001/116*0048*, L275, L720	639/639-4/639-5	08.03-09.10	6 1/2 J x 16	205/65R16	225/60R16			16156	R1-1793	4250906817936	9897	ME616017	66,5	112	5	60	30	146,40
Vito II (Facelift)	110CDI/113CDI/116CDI/122CDI		bis e1*2007/46*0458*07, bis -/457*08, bis -/459*05	639-2/639-4/639-5	10.10-07.14	6 1/2 J x 16	205/65R16	225/60R16			16156	R1-1793	4250906817936	9897	ME616017	66,5	112	5	60	30	146,40
Vito E-CELL	Elektroantrieb	Elektroantrieb	e1*KS07/46*0028*, e1*2007/46*0621*	639-2E/639-4E	05.12-07.14	6 1/2 J x 16	205/65R16				16156	R1-1793	4250906817936	9897	ME616017	66,5	112	5	60	30	146,40
Vito III/Tourer/Kasten/Mixto	109CDI/111CDI/114CDI/116CDI/119CDI		ab e1*2007/46*0457*10, ab e1*2007/46*0458*08	639-2/639-4	08.14-	6 1/2 J x 16	195/65R16	205/65R16	225/50R16		16207	R1-1911	4250906819114	6501	ME516027	66,5	112	5	52	30	128,10
Vito III/Tourer/Kasten/Mixto/e-Vito	109CDI/111CDI/114CDI/116CDI/119CDI/4-matic/Elektro (85kW)		ab e1*2007/46*0457*09, ab e1*2007/46*0458*08, ab e1*2007/46*0459*06	639-2/639-4/639-5	08.14-	6 1/2 J x 17	225/55R17				17012	R1-1912	4250906819121	9002	ME517007	66,5	112	5	50	25	149,20
X-Klasse	X220d/X250d/e-matic		e9*2007/46*6531*, e9*2007/46*6531*	4701	11.17-	7 1/2 J x 17	255/60R17				17027	R1-2037	4250906820370	9031	ME617002	66	114,3	6	50	25	160,90

Modell- bezeichnung	Motorvarianten	Bemerkungen	ABE-Nummer	Fahrzeugtyp	Bauzeit von/bis	Radab- messung	Reifengröße		MWD- Nr.	MW-AM Nr.	EAN-Nr.	Alcar- Nr.	KPZ- Nr.	Bemerk.	Anschlussmaße				Stk.	Preis in €
Car model	Motorversion	General remarks	ABE-Number	Project Code	Production year	Wheel Size	Tyre Size		MWD- Ref.	MW-AM Ref.	EAN-Nr.	Alcar- Ref.	KPZ- Ref.	Remarks	Techn. Connection				Qty.	Price in €
															Center hole	Pitch circle diameter	Hole number	Offset in mm	p.Pal.	exkl. MwSt.

Mini



15142

15274

16157

Mini One/Cooper/ Cabrio	1.4-16V/1.6D/1.6-16V Cabrio 1.6i-16V	nicht für Cooper S	e1*98/14*0168*, e1*2001/116*0231*, -/343*	R50/Mini/Mini-N	09.01 - 01.10	5 1/2 J x 15	175/65R15			15142	R1-1417	4250906814171	8155	BM515015	56	100	4	45	48	106,80
Mini One/Cooper/ Cabrio	1.4-16V/1.6D/1.6-16V Cabrio 1.6i-16V		bis e1*2007/46*0371*09, -/369*	UKL-L/UKL-C	02.10 - 11.15	5 1/2 J x 15	175/65R15			15142	R1-1417	4250906814171	8155	BM515015	56	100	4	45	48	106,80
Mini Clubman	1.4-16V/1.6-16V/1.6D		e1*2001/116*0343*, e1*2007/46*0370*	Mini-N/UKL-K	10.07 - 08.15	5 1/2 J x 15	175/65R15			15142	R1-1417	4250906814171	8155	BM515015	56	100	4	45	48	106,80
Mini II One/Cabrio/ Cooper (F55/56/57)	1.2/1.5/1.5D		ab e1*2007/46*0371*10, e1*2007/46*1678*, -/1679*, -/1680*	UKL-L/FML2/FML4/FMCA	04.14 -	5 1/2 J x 15	175/65R15			15274	R1-1915	4250906819152	7605	BM515019	66,5	112	5	46	48	98,90
Mini Countryman (R60)	1.6/1.6D/2.0D/One/Cooper/ALL4		e1*2007/46*0496*, e24*2007/46*0023*	UKL-X/UKL-N1	09.10 - 12.16	6 1/2 J x 16	195/60R16	205/60R16		16157	R1-1802	4250906818025	8157	BM516024	72,5	120	5	46	30	110,70
Mini Paceman	1.6/1.6D/1.6JCW/2.0D/Cooper/ALL4		e1*2007/46*0563*	UKL-C/X	03.13 - 12.16	6 1/2 J x 16	195/60R16	205/60R16		16157	R1-1802	4250906818025	8157	BM516024	72,5	120	5	46	30	110,70

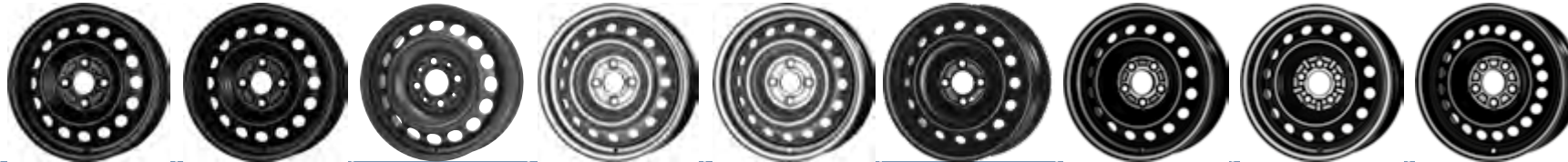

14195 14203 15177 15242 15243 15301 16132 16141 16166

ASX	1.8MIVEC/1.8D-D/2WD/4WD		e1*2007/46*0368*	GA0	07.10-01.23	6½J x16	215/65R16	215/70R16		16166	R1-1822	4250906818223	9427	MT516005		67	114,3	5	46	30	129,70
ASX	1.0T/1.3T Hybrid/1.6T Hybrid		e2*2007/46*0684*21	RJB	02.23-	6½J x16	215/65R16			16284	R1-2076	4250906820769	7312		N	66	114,3	5	32	30	100,80
Attrage	1.2 MIVEC		e1*2007/46*1230*	A10	11.14-	5J x14	175/65R14			14203	R1-1951	4250906819510	3005			56	100	4	38	54	94,70
Colt/CZ3/CZT	1.1MPI/1.3MPI/1.5MPI/1.5DI-D		e1*2001/116*0271*, e1*2007/46*0618*	Z30/Z3V	05.04-12.12	6J x15	185/55R15	195/50R15		15177	R1-1575	4250906815758	7960	MC515005		67	114,3	4	46	40	116,30
Colt CZC	1.5i/1.5i-Turbo		e1*2001/116*0368*	Z38	05.06-12.12	6J x15	185/55R15	195/50R15		15177	R1-1575	4250906815758	7960	MC515005		67	114,3	4	46	40	116,30
Colt					09.23-	6J x15				15301	R1-2045	4250906820455	4444		N	60	100	4	31	48	96,80
Colt					09.23-	6½J x16				16302					N	60	100	4	37	30	
Eclipse Cross	1.5T-MIVEC/2.3/2WD/4WD		e1*2007/46*1769*	GKO	12.17-	6½J x16	215/70R16			16141	R1-1880	4250906818803	9657	PS516020		67	114,3	5	38	30	129,80
i-Miev	Elektroantrieb (49kW)	nur auf Vorderachse	e1*2007/46*0527*, -/619*	HAD/HAV	01.11-12.18	4J x15	145/65R15			15242	R1-1805	4250906818056	7160	PS515049		56	100	4	35	48	115,70
i-Miev	Elektroantrieb (49kW)	nur auf Hinterachse	e1*2007/46*0527*, -/619*	HAD/HAV	01.11-12.18	5J x15	175/55R15			15243	R1-1806	4250906818063	7235	PS515050		54	100	4	35	48	115,00
Lancer/Sportback	1.5MPI/1.5MIVEC/1.8MPI/1.8MIVEC/2.0DI-D		e1*2001/116*0441*	CY0	11.07-12.17	6½JJ x16	205/60R16			16125	R1-1737	4250906817370	9228	MT516004		67	114,3	5	46	30	117,40
Outlander II	2.0DI-D/2.2DI-D/2.4/2.4MIVEC/4WD / 2.0MIVEC/2.4/2WD		bis e1*2001/116*0406*14, -/482*	CW0/CWB	02.07-07.12	6½JJ x16	215/70R16			16132	R1-1753	4250906817530	9407	MT516003		67	114,3	5	38	30	129,80
Outlander III	2.0MIVEC/2.2DI-D/Hybrid 2.0PHEV		ab e1*2001/116*0406*15, e1*2007/46*1218*	CW0/GF0	08.12-	6½J x16	215/70R16			16141	R1-1880	4250906818803	9657	PS516020		67	114,3	5	38	30	129,80
Space Star	1.0/1.2		e1*2007/46*0951*	A00	01.13-	4½J x14	165/65R14			14195	R1-1900	4250906819008	5215	MT514013		56	100	4	46	56	93,30

Modell- bezeichnung	Motorvarianten	Bemerkungen	ABE-Nummer	Fahrzeugtyp	Bauzeit von/bis	Radab- messung	Reifengröße	MWD- Nr.	MW-AM Nr.	EAN-Nr.	Alcar- Nr.	KPZ- Nr.	Bemerk.	Anschlussmaße	Stk. p.Pal.	Preis in € exkl. MwSt.	
Car model	Motorversion	General remarks	ABE-Number	Project Code	Production year	Wheel Size	Tyre Size	MWD- Ref.	MW-AM Ref.	EAN-Nr.	Alcar- Ref.	KPZ- Ref.	Remarks	Techn. Connection	Qty. p.Pal.	Price in € without TVA	
													Center hole	Pitch circle diameter	Hole number	Offset in mm	

Nissan

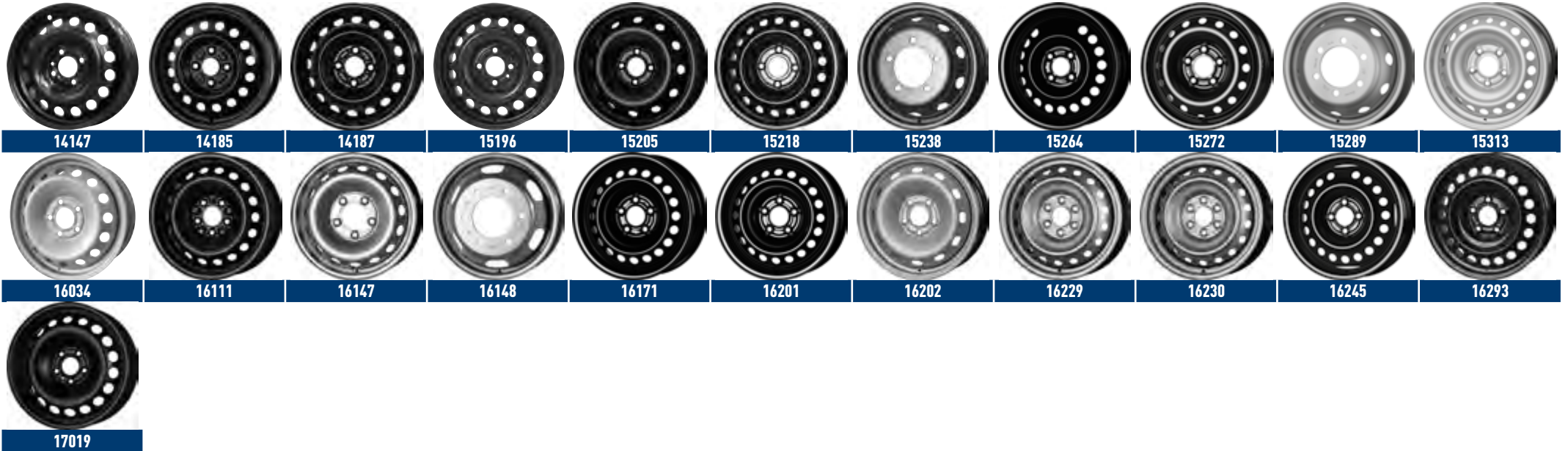

Almera	1.5i/1.5dCi/1.8i/2.2dCi		e11*98/14*0129*	N16	02.00-12.06	6 J x 15	175/70R15	185/65R15	195/60R15	15105	R1-1270	4250906812702	8410	NI515004	66	114,3	4	45	40	112,80
Juke	1.5dCi/1.6/1.6DIG-T/4x2/4x4		bis e11*2007/46*0132*13	F15	12.10-05.14	6 1/2 J x 16	205/60R16	215/60R16		16171	R1-1834	4250906818346	8177	NI516004	66	114,3	5	40	30	118,80
Juke	1.5dCi/1.6/1.6CVT/1.6DIG-T/4x2/4x4		ab e11*2007/46*0132*14, e5*2007/46*1031*	F15	06.14-12.19	6 1/2 JJ x 16	205/60R16			16201	R1-1897	4250906818971	7856	NI516005	66	114,3	5	40	30	106,90
Juke	DIG-T117		ab e9*2007/46*6697*01	F16	12.19-	6 1/2 J x 16	215/65R16			16284	R1-2076	4250906820769	7312		66	114,3	5	32	30	100,80
Leaf	Elektroantrieb (80kW)		e11*2007/46*0230*	ZEO	03.11-02.18	6 1/2 JJ x 16	205/55R16			16201	R1-1897	4250906818971	7856	NI516005	66	114,3	5	40	30	106,90
Leaf II	Leaf 40kW/62kW (110/160kW)		e9*2007/46*6537*	ZE1	03.18-	6 1/2 JJ x 16	205/55R16			16201	R1-1897	4250906818971	7856	NI516005	66	114,3	5	40	30	106,90
Micra	1.0i/1.2i/1.4i		e11*2001/116*0195*	K12	03.03-09.10	5 J x 14	165/70R14			14147	R1-1436	4250906814362	5820	NI514012	60	100	4	45	56	97,30
Micra/Micra CC	1.0i/1.2i/1.4i/1.5dCi/1.6i / CC 1.4i/1.6i		e11*2001/116*0195*	K12	03.03-09.10	5 1/2 J x 15	175/60R15	175/65R15		15149	R1-1435	4250906814355	8305	NI515007	60	100	4	50	48	108,70
Micra	1.2VTC		e13*2007/46*1111*	K13	10.10-03.17	5 1/2 J x 14	165/70R14			14187	R1-1794	4250906817943	7030	NI514013	60	100	4	45	48	90,50
Micra	1.2VTC		e13*2007/46*1111*	K13	10.10-03.17	5 1/2 J x 15	175/60R15			15149	R1-1435	4250906814355	8305	NI515007	60	100	4	50	48	108,70
Micra IV	0.9IG-T/1.0i/1.5dCi/1.0iG-T100		e9*2007/46*6454*	K14	04.17-	6 J x 15	185/65R15			15205	R1-1684	4250906816847	4130	NI515011	60	100	4	50	40	95,80

Micra IV	0.9iG-T/1.0i/1.5dCi90		e9*2007/46*6454*	K14	04.17-	6 J x16	195/55R16			16245	R1-1997	4250906819978	7130	NI516006	60	100	4	50	30	111,50
Note	1.4i/1.5dCi/1.6i		e11*2001/116*0268*	E11	03.06-09.13	5 1/2 J x15	175/65R15	185/65R15		15196	R1-1630	4250906816304	6775	NI515008	60	100	4	45	48	108,60
Note II	1.2/1.2DIG-S/1.5dCi		e11*2007/46*0753*	E12	10.13-12.17	5 1/2 J x15	185/65R15			15264	R1-1891	4250906818919	7340	NI515010	60	100	4	40	48	97,40
NV200 electric	e-NV 200		e11*2007/46*1339*, -/1340*	MEON	04.14-	6 J x15	185/65R15			15272	R1-1898	4250906818988			66	114,3	5	45	40	96,10
Pixo	1.0		e6*2001/116*0124*	HF	07.09-12.13	4 1/2 J x14	155/65R14			14185	R1-1763	4250906817639	5400	SU514008	54	100	4	45	56	93,20
Primera	1.6i/1.8i/2.0i/2.0TD/2.0i/Traveller 1.6i/1.8i/2.0i/2.0TD		e11*93/81*0060*	P11	09.96-03.02	6 J x15	185/65R15	195/60R15		15105	R1-1270	4250906812702	8410	NI515004	66	114,3	4	45	40	112,80
Pulsar	1.2DIG-T/1.5dCi		e9*2007/46*3086*	C13	10.14-12.18	6 1/2 JJ x16	195/60R16	205/55R16		16201	R1-1897	4250906818971	7856	NI516005	66	114,3	5	40	30	106,90
Qashqai	1.5dCi/1.6i/2.0i/2.0dCi/2.0CVT/2.0i-4x4/2.0dCi-4x4/2.0CVT-4x4		e11*2001/116*0295*	J10	02.07-02.14	6 1/2 J x16	215/65R16			16111	R1-1740	4250906817400	7855	NI516003	66	114,3	5	40	30	120,60
Qashqai II	1.2DIG-T/1.3DIG-T/1.5dCi/1.6dCi/1.6DIG-T/1.7dCi		e11*2007/46*0963*, e5*2007/46*1029*	J11	03.14-05.21	6 1/2 JJ x16	215/65R16			16201	R1-1897	4250906818971	7856	NI516005	66	114,3	5	40	30	106,90
Qashqai III	1.3DIG-T Mild-Hybrid		e9*2018/858*11042*	J12	06.21-	7 J x17	215/65R17			17019	R1-1946	4250906819466	9006	RE517005	66	114,3	5	37	20	132,80
Tiida	1.5dCi/1.6i/1.8i		e11*2001/116*0296*	C11	01.08-12.11	5 1/2 JJ x15	185/65R15	195/65R15		15218	R1-1728	4250906817288	7730	NI515009	66	114,3	4	40	48	89,70

Nissan Nfz.

Cabstar	2.5D/3.0D		e9*2007/46*0030*	F241	05.07-03.12	5 J x15	195/70R15			15238	R1-1833	4250906818339	RE615005		130	170	5	106,5	40	114,50	
Cabstar	2.5D		e9*2007/46*0030*	F241	04.12-	5 J x15	195/70R15			15289	R1-1972	4250906819725			130	170	6	106,5	40	114,60	
Navara/NP300	2.3dCi/4x2/4x4		bis e9*2007/46*6364*	D231	11.15-09.19	6 J x16	205R16			16229	R1-1965	4250906819657			66	114,3	6	55	30	111,60	
Navara/NP300	2.3dCi/4x2/4x4		bis e9*2007/46*6364*06	D231	11.15-05.19	7 J x16	205R16	255/70R16		16230	R1-1966	4250906819664	7921		66	114,3	6	45	30	144,10	
NV300	1.6dCi95/2.0dCi110/120/130/145/150/170		ab e2*2007/46*0037*11, ab e2*98/14*0271*35	J4/4	01.15-	6 J x16	205/65R16	215/65R16		16202	R1-1896	4250906818964	7503	RE616016	66	114,3	5	50	30	111,90	
NV400	2.3dCi100/110/130/170		e2*2007/46*0137*, -/138*, -/140*, -/142*	M1/M2/M6/M9	12.11-	6 1/2 J x16	215/65R16	225/65R16	235/65R16	16147	R1-1765	4250906817653	9133	RE616012	89	130	5	66	30	126,00	
NV400	2.3dCi	Zwillingsbereifung AL hinten 3.200 kg	e2*2007/46*0137*, -/138*, -/140*, -/141*	M1/M2/M6/M7	12.11-	5 1/2 J x16	195/75R16			16148	R1-1799	4250906817998	8733	RE616015	142,1	200	6	110	30	170,50	
Primastar	1.9-dCi/2.0i-16V/2.5dCi		bis e2*14*0271*35, bis e2*2007/46*0037*11, K995	F4/J4/4	10.06-12.14	6 J x16	195/65R16	205/65R16	215/65R16	16034	R1-1373	4250906813730	9506	RE616008	71	118	5	50	30	114,50	
Townstar	DIG-T130		e2*2018*858*00024*, 00025*	NFK	01.22-	6 J x15	195/65R15			15313	R1-2099	4250906820998	4517		N	66	114,3	5	35	40	99,70
Townstar	DIG-T130		e2*2018*858*00024*, 00025*	NFK	01.22-	6 J x16	205/60R16			16293	R1-2112	4250906821124	6516		N	66	114,3	5	38	30	109,60

Astra-G	1.2i-16V/1.6i/1.6i-16V/1.7TD/1.8i-16V	e1*97/27*0086*, -/87*, e1*97/27*0101*, e1*98/14*0086*, -/87*, -/101*	T98/T98NB/T98-Kombi	04.98-02.04	5 1/2 J x 14	165/70R14	175/70R14	185/65R14	14110	R1-1077	4250906810777	6160	OP514004	56,5	100	4	39	48	85,10	
Astra-G	1.2i-16V/1.6i/1.6i-16V/1.7TD/1.8i-16V	e1*97/27*0086*, -/87*, e1*97/27*0101*, e1*98/14*0086*, -/87*, -/101*	T98/T98NB/T98-Kombi	04.98-02.04	6 J x 15	185/65R15	195/60R15		15048	R1-1294	4250906812948	8390	OP515008	56,5	100	4	49	40	104,40	
Astra-G	1.6CNG/1.8i-16V/2.0i-16V/2.0DI/2.0DTI-16V/2.2i-16V	e1*97/27*0086*, -/87*, e1*97/27*0101*, e1*98/14*0086*, -/87*, -/101*, e1*2001/116*0216*	T98/T98NB/T98-Kombi/T98-CNG	04.98-02.04	6 J x 15	185/65R15	195/60R15		15092	R1-1318	4250906813181	8060	OP515016	65	110	5	49	40	104,40	
Astra-G Coupé/Cabrio	1.6i-16V/1.8i-16V	e1*98/14*0132*	T98C	02.00-04.05	6 J x 15	185/65R15	195/60R15		15048	R1-1294	4250906812948	8390	OP515008	56,5	100	4	49	40	104,40	
Astra-G Coupé/Cabrio	1.6i-16V/1.8i-16V/2.2i-16V	e1*98/14*0132*	T98C	02.00-04.05	6 J x 15	185/65R15	195/60R15		15092	R1-1318	4250906813181	8060	OP515016	65	110	5	49	40	104,40	
Astra-H	1.4/1.4-Twinport eco Flex/1.6/Ecotec	e1*2001/116*0261*, -/293*, -/454*, e50*2001/116*0007*, e1*2007/46*0340*, -/341*, -/344*	A-H/A-H-NB/A-H-SW/GMIH	03.04-05.12	6 1/2 J x 15	185/65R15	195/60R15	195/65R15	15164	R1-1559	4250906815598	8365	OP515022	56,5	100	4	35	40	92,90	
Astra-H	1.3CDTI/1.6/1.7-CDTI/1.8/Ecotec	e1*2001/116*0261*, -/293*, -/454*, e1*2007/46*0340*, -/341*, -/344*, e50*2001/116*0007*, -/08*	A-H/A-H-NB/A-H-SW/GMIH/GMU	03.04-05.12	6 1/2 J x 15	185/65R15	195/60R15	195/65R15	15144	R1-1463	4250906814638	9245	OP515027	65	110	5	35	40	92,50	
Astra-H	1.3-CDTI/1.4/1.6/1.6-Turbo/1.7-CDTI/1.8/1.9-CDTI/2.0-Turbo/Ecotec	e1*2001/116*0261*, -/293*, -/454*, e1*2007/46*0340*, -/341*, -/344*, e50*2001/116*0007*, -/08*	A-H/A-H-SW/A-H-NB/GMIH/GMU	03.04-05.12	6 1/2 J x 16	205/55R16			16057	R1-1560	4250906815604	9045	OP516007	65	110	5	37	40	107,30	
Astra-H GTC	1.4/1.6/Ecotec	e4*2001/116*0094*	A-H/C	03.05-12.11	6 1/2 J x 15	185/65R15	195/60R15	195/65R15	15164	R1-1559	4250906815598	8365	OP515022	56,5	100	4	35	40	92,90	
Astra-H GTC	1.3CDTI/1.4/1.6/1.7CDTI/1.8/Ecotec	e4*2001/116*0094*	A-H/C	03.05-12.11	6 1/2 J x 15	185/65R15	195/60R15	195/65R15	15144	R1-1463	4250906814638	9245	OP515027	65	110	5	35	40	92,50	
Astra-H GTC/Twintop	Coupé/1.3CDTI/1.4/1.6/1.7CDTI/1.8/1.9CDTI/2.0-Turbo/ Ecotec Cabrio/1.6/1.8/1.9CDTI/2.0-Turbo/ Ecotec	e4*2001/116*0094*	A-H/C	03.05-12.11	6 1/2 J x 16	205/55R16			16057	R1-1560	4250906815604	9045	OP516007	65	110	5	37	40	107,30	
Astra-J/Sports-Tourer	1.3CDTI/1.4/1.4Turbo/1.6	e1*2007/46*0141*, -/204*, e4*2007/46*0308*	P-J/-SW/-V	12.09-12.18	6 1/2 J x 16	205/55R16	205/60R16	215/60R16	16143	R1-1776	4250906817769	9247	OP516013	56,5	105	5	39	30	103,00	
Astra-J/Sports-Tourer	1.6Turbo/1.7CDTI/2.0CDTI	e1*2007/46*0141*, -/204*, e4*2007/46*0308*	P-J/-SW/-SW-V	12.09-12.18	6 1/2 J x 16	205/55R16	205/60R16	215/60R16	16144	R1-1777	4250906817776	9327	OP516014	70,3	115	5	41	30	103,90	
Astra-J GTC	1.4/1.4-Turbo/1.6-Turbo/1.6-SIDI-Turbo/1.7CDTI/2.0CDTI/2.0-BiTurbo CDTI	e4*2007/46*0204*	P-J/SW	01.12-12.18	7 J x 17	225/55R17	235/55R17		17014	R1-1932	4250906819329	9947		70,3	115	5	41	25	133,70	
Astra-K/Sports Tourer	1.0Ecotec/1.4Ecotec/1.6Ecotec/1.6CDTI/1.2DI-DI-Turbo/1.5D	e4*2007/46*0996*	B-K	12.15-12.21	6 J x 15	195/65R15			15286	R1-1952	4250906819527	6365	OP515029	56,6	105	5	37	40	88,90	
Astra-K/Sports Tourer	1.0Ecotec/1.4Ecotec/1.6Ecotec/1.6CDTI/1.2DI-DI-Turbo/1.5D	e4*2007/46*0996*	B-K	12.15-12.21	6 1/2 J x 16	205/55R16	215/55R16		16225	R1-1953	4250906819534	7035	OP516017	56,6	105	5	41	30	98,60	
Astra-L/ Sportstourer	1.2Turbo/1.5Diesel	e2*2007/46*0628*	F	11.21-	7 J x 16	205/55R16			16191	R1-1882	4250906821247	9834		N	65	108	5	44	30	105,10
Cascada	1.4/1.4-Turbo/1.6-SIDI Turbo	e4*2007/46*0204*	P-J/SW	05.13-12.19	7 J x 17	225/55R17	235/55R17		17014	R1-1932	4250906819329	9947		70,3	115	5	41	25	133,70	
Combo Combi/Tour	1.3-CDTI/1.4i-Twinport/1.6i/1.7DI/1.7DTI	e1*98/14*0179*, DE*2007/46*0129*, e1*2007/46*0129*, -/291*	Combo-C/-Van	11.01-12.11	5 1/2 J x 14	175/65R14	175/70R14		14165	R1-1588	4250906815888	6480	OP614001	56,5	100	4	49	48	90,70	
Combo Combi/Tour	1.3-CDTI/1.4i-Twinport/1.6i/1.6CNG/1.7DI/1.7DTI	e1*98/14*0179*, e1*20001/116*0327*, DE*2007/46*0129*, -/131*, e1*2007/46*0129*, -/131*, -/291*, -/293*, e4*2007/46*0299*	Combo-C/CNG/-Van/-V	11.01-12.11	6 J x 15	185/55R15	185/60R15		15222	R1-1783	4250906817837	8375	OP615001	56,5	100	4	49	40	98,20	
Combo Combi/Tour	1.6-CNG/1.7-CDTI	e1*98/14*0179*, e1*20001/116*0327*, DE*2007/46*0129*, -/131*, e1*2007/46*0129*, -/131*, -/291*, -/293*	Combo-C/-CNG/-Van/-Van-CNG	11.01-12.11	6 J x 15	185/55R15	185/60R15	185/65R15	15092	R1-1318	4250906813181	8060	OP515016	65	110	5	49	40	104,40	

Modell- bezeichnung	Motorvarianten	Bemerkungen	ABE-Nummer	Fahrzeugtyp	Bauzeit von/bis	Radab- messung	Reifengröße			MWD- Nr.	MW-AM Nr.	EAN-Nr.	Alcar- Nr.	KPZ- Nr.	Bemerk.	Anschlussmaße				Stk. p.Pal.	Preis in € exkl. MwSt.		
Car model	Motorversion	General remarks	ABE-Number	Project Code	Production year	Wheel Size	Tyre Size			MWD- Ref.	MW-AM Ref.	EAN-Nr.	Alcar- Ref.	KPZ- Ref.	Remarks	Techn. Connection				Qty. p.Pal.	Price in € without TVA		
																Center hole	Pitch circle diameter	Hole number	Offset in mm				

Opel (Fortsetzung)

Combo Life	1.2/1.5D		e2*2007/46*0622*	E	09.18-	6 1/2 J x 15	195/65R15			15302	R1-2056	4250906820561	5477	PS615004		65	108	5	42	40	102,60
Combo Life	1.2/1.5D	Radlast 610 kg	e2*2007/46*0622*	E	09.18-	6 1/2 J x 16	205/60R16			16190	R1-1887	4250906818872	7460	PS616004		65	108	5	47	30	108,30
Combo-e Life	Combo-e Elektroantrieb (100kW)		ab e2*2007/46*0622*13	E	09.21-	6 1/2 J x 16	205/60R16			16289	R1-2094	4250906820943	7461	PS616004		65	108	5	47	30	108,30
Corsa-B	1.0Eco/1.2i/1.2i-16V/1.4i/1.4iS/1.4i-16V/1.5D/1.5TD/1.7D		G290, e1*96/27*0053*, e1*98/14*0053*, e1*97/27*0098*, e1*98/14*0098*	Corsa-B/S93/S93 Kombi	03.93-09.00	5 J x 13	145 R 13	145/80R13	165/70R13	13032	R1-964	4250906809641	3240	OP513004		56,5	100	4	49	54	63,40
Corsa-C	1.0i-12V/1.2i-16V/1.3CDTI/1.4i-16V/1.7DI-16V/1.7DTI-16V/1.8i-16V GSi		e1*98/14*0148*	Corsa-C	10.00-08.06	5 1/2 J x 14	175/65R14			14132	R1-1508	4250906815086	6790	OP514018		56,5	100	4	49	40	84,40
Corsa-C	1.0i-12V/1.2i-16V/1.3CDTI/1.4i-16V/1.7DI-16V/1.7DTI-16V/1.8i-16V GSi		e1*98/14*0148*	Corsa-C	10.00-08.06	6 J x 15	185/55R15			15048	R1-1294	4250906812948	8390	OP515008		56,5	100	4	49	40	104,40
Corsa-C	1.7CDTI		e1*98/14*0148*	Corsa-C	07.03-08.06	6 J x 15	185/55R15			15092	R1-1318	4250906813181	8060	OP515016		65	110	5	49	40	104,40
Corsa-D	1.0i/1.2i/1.2LPG/1.3CDTI/1.4i/1.4LPG/Ecotec		bis e1*2001/116*0379*29, E50*2001/116*0001*	S-D/GMIB	09.06-12.14	5 1/2 J x 14	175/70R14	185/70R14		14170	R1-1662	4250906816625	6515	OP514021		56,5	100	4	39	54	72,60
Corsa-D	1.0i/1.2i/1.2LPG/1.3CDTI/1.4i/1.4LPG/Ecotec		bis e1*2001/116*0379*29, E50*2001/116*0001*	S-D/GMIB	09.06-12.14	6 J x 15	185/60R15	185/65R15	195/60R15	15193	R1-1648	4250906816489	6445	OP515024		56,5	100	4	39	40	85,90
Corsa-E	1.0/1.2/1.4		ab e1*2001/116*0379*30	S-D	12.14-12.19	5 1/2 J x 14	175/70R14	185/70R14		14170	R1-1662	4250906816625	6515	OP514021		56,5	100	4	39	54	72,60
Corsa-E	1.0/1.2/1.3CDTI/1.4/1.4-Turbo		ab e1*2001/116*0379*30	S-D	12.14-12.19	6 J x 15	185/65R15			15193	R1-1648	4250906816489	6445	OP515024		56,5	100	4	39	40	85,90
Corsa-F	1.2		e2*2007/46*0639*	U	11.19-	6 J x 15	185/65R15			15303	R1-2060	4250906820608	6593			65	108	4	32	40	97,60
Corsa-F	1.2/1.2-Turbo/1.5d		e2*2007/46*0639*	U	11.19-	6 1/2 J x 16	195/55R16			16274	R1-2061	4250906820615	7493			65	108	4	38	30	96,80
Corsa-F Elektro	Corsa-e Elektro (100kW)		ab e2*2007/46*0639*10	U	05.20-	6 1/2 J x 16	195/55R16			16273	R1-2059	4250906820592	7432			65	108	4	32	30	104,20
Crossland-X	1.2/1.5D/1.6D		e4*2007/46*1194*	P7 Monocab C	08.17-	6 1/2 J x 15	195/65R15			15261	R1-1889	4250906818896	7385	PS515052		65	108	4	20	40	93,70
Crossland-X	1.2/1.5D/1.6D		e4*2007/46*1194*	P7 Monocab C	08.17-	6 1/2 J x 16	195/60R16	205/60R16		16189	R1-1890	4250906818902	9432	PS516021		65	108	4	20	30	97,90
Crossland-X	1.2/1.5D/1.6D	Stylingrad	e4*2007/46*1194*	P7 Monocab C	08.17-	6 1/2 J x 16	195/60R16			16278	R1-2020	4250906820202				65	108	4	23	30	99,90
Grandland-X/ Grandland	1.2-Turbo/1.5-D/1.6-Turbo/1.6D/2.0-D		e2*2007/46*0597*	Z	12.17-	7 J x 16	215/70R16			16191	R1-1882	4250906821247	9834	N	65	108	5	44	30	105,10	
Grandland-X/ Grandland	1.2-Turbo/1.5-D/1.6-Turbo/1.6D/2.0-D		e2*2007/46*0597*	Z	12.17-	7 J x 17	215/65R17			17025	R1-1996	4250906819961	9036	PS517006		65	108	5	42	25	115,90
Insignia II Grand Sport/Sports Tourer	1.5/1.6D		e8*2007/46*0264*	Z-B	04.17-	6 1/2 J x 16	215/60R16			16144	R1-1777	4250906817776	9327	OP516014		70,3	115	5	41	30	103,90
Karl/Karl Rocks	1.0		e4*2007/46*0957*	D-A	04.15-12.19	5 J x 14	165/65R14			14201	R1-1954	4250906819541	3015	OP514022		56,5	100	4	38	54	69,70

Modell- bezeichnung	Motorvarianten	Bemerkungen	ABE-Nummer	Fahrzeugtyp	Bauzeit von/bis	Radab- messung	Reifengröße			MWD- Nr.	MW-AM Nr.	EAN-Nr.	Alcar- Nr.	KPZ- Nr.	Bemerk.	Anschlussmaße				Stk. p.Pal.	Preis in € exkl. MwSt.		
Car model	Motorversion	General remarks	ABE-Number	Project Code	Production year	Wheel Size	Tyre Size			MWD- Ref.	MW-AM Ref.	EAN-Nr.	Alcar- Ref.	KPZ- Ref.	Remarks	Techn. Connection				Qty. p.Pal.	Price in € without TVA		
																Center hole	Pitch circle diameter	Hole number	Offset in mm				

Opel Nfz.

Astra-Van	1.6i/1.7D/2.0D		K182	Astra-G-Van	07.98-04.05	5 1/2 J x 14	175/70R14	185/65R14	185/70R14	14110	R1-1077	4250906810777	6160	OP514004		56,5	100	4	39	48	85,10
Astra-Van	1.6i/1.7D/2.0D		K182	Astra-G-Van	07.98-04.05	6 J x 15	185/65R15	195/60R15		15048	R1-1294	4250906812948	8390	OP515008		56,5	100	4	49	40	104,40
Astra-H/Van	1.3CDTi/1.7CDTi		e1*2007/46*0576*	A-H/Van	05.05-01.11	6 1/2 J x 15	195/65R15			15144	R1-1463	4250906814638	9245	OP515027		65	110	5	35	40	92,50
Astra-H/Van	1.3CDTi/1.7CDTi/1.9CDTi/2.0CDTi		e1*2007/46*0576*	A-H/Van	05.05-01.11	6 1/2 J x 16	205/55R16			16057	R1-1560	4250906815604	9045	OP516007		65	110	5	37	40	107,30
Astra-J Van	1.3CDTi/1.4/1.6		e4*2007/46*0309*	P-J/V	12.11-12.18	6 1/2 J x 16	205/60R16	215/60R16		16143	R1-1776	4250906817769	9247	OP516013		56,5	105	5	39	30	103,00
Astra-J Van	1.6CDTi/1.7CDTi		e4*2007/46*0309*	P-J/V	12.11-12.18	6 1/2 J x 16	205/60R16	215/60R16		16144	R1-1777	4250906817776	9327	OP516014		70,3	115	5	41	30	103,90
Combo-C	1.3-CDTi/1.4i-Twinport/1.6i/1.7DI/1.7DTi/Ecotec		e1*98/14*0179*, DE*2007/46*0129*, e1*2007/46*0129*, -/291*, K886	Combo-C/Van	11.01-12.11	5 1/2 J x 14	175/65R14	175/70R14		14165	R1-1588	4250906815888	6480	OP614001		56,5	100	4	49	48	90,70
Combo-C	1.3-CDTi/1.4i-Twinport/1.6i/1.6CNG/1.7DI/1.7DTi/ Ecotec		e1*98/14*0179*, e1*2001/116*0327*, DE*2007/46*0129*, -/131*, e1*2007/46*0129*, -/131*, -/291*, -/293*, e4*2007/46*0299*, K886, L620	Combo-C/-CNG/-Van/-V	06.02-12.11	6 J x 15	185/55R15	185/60R15		15222	R1-1783	4250906817837	8375	OP615001		56,5	100	4	49	40	98,20
Combo-C	1.6CNG/1.7CDTi/Ecotec		e1*98/14*0179*, e1*2001/116*0327*, DE*2007/46*0129*, -/131*, e1*2007/46*0129*, -/131*, -/291*, -/293*, K886, L620	Combo-C/-CNG/-Van/- Van-CNG	06.02-12.11	6 J x 15	185/55R15	185/60R15	185/65R15	15092	R1-1318	4250906813181	8060	OP515016		65	110	5	49	40	104,40
Combo-D	1.3CDTi/1.4/1.6CDTi		e3*2007/46*0076*, -/79*	Combo-D/Combo-D-Van	12.11-	6 J x 15	185/65R15	195/65R15		15232	R1-1741	4250906817417	7395	FL615006		58	98	5	39	48	100,90
Combo-D	1.3CDTi/1.4/1.4CNG/1.6CDTi/2.0CDTi		e3*2007/46*0076*, -/79*	Combo-D/Combo-D-Van	12.11-	6 J x 16	195/60R16			16154	R1-1786	4250906817868	8049	FL616007		58	98	5	36,5	30	101,10
Combo Cargo	1.2/1.5D/1.6D		e2*2007/46*0623*	E	09.18-	6 1/2 J x 15	195/65R15			15302	R1-2056	4250906820561	5477	PS615004		65	108	5	42	40	102,60
Combo Cargo/ Cargo XL/Combo-e Cargo	1.2/1.5D/1.6D/Combo-e Cargo Elektroantrieb (100kW)	Radlast 700 kg	e2*2007/46*0623*	E	09.18-	6 1/2 J x 16	205/60R16	215/65R16		16289	R1-2094	4250906820943	7461	PS616004		65	108	5	47	30	108,30
Corsa-B-Van	1.7D		H393	Corsa-B-LFW	01.96-10.01	5 J x 13	145 R 13	145/80R13	165/70R13	13032	R1-964	4250906809641	3240	OP513004		56,5	100	4	49	54	63,40
Corsa-C Van	1.2i/1.3-CDTi/1.4i/Ecotec		L659	Corsa-C-Van	07.05-02.11	5 1/2 J x 14	175/65R14			14165	R1-1588	4250906815888	6480	OP614001		56,5	100	4	49	48	90,70
Corsa-C Van	1.2i/1.3-CDTi/1.4i/Ecotec		L659	Corsa-C-Van	07.05-02.11	6 J x 15	185/55R15			15222	R1-1783	4250906817837	8375	OP615001		56,5	100	4	49	40	98,20
Corsa-C Van	1.7CDTi-Ecotec		L659	Corsa-C-Van	07.05-02.11	6 J x 15	185/55R15			15092	R1-1318	4250906813181	8060	OP515016		65	110	5	49	40	104,40
Corsa-D Van	1.0/1.2/1.3CDTi		bis e1*2007/46*0505*08, bis e50*2007/46*0055*04	S-D/-Van/-V	12.10-03.15	5 1/2 J x 14	185/70R14			14170	R1-1662	4250906816625	6515	OP514021		56,5	100	4	39	54	72,60
Corsa-D Van	1.0/1.2/1.3CDTi		bis e1*2007/46*0505*08, bis e50*2007/46*0055*04	S-D/-Van/-V	12.10-03.15	6 J x 15	185/60R15	185/65R15	195/60R15	15193	R1-1648	4250906816489	6445	OP515024		56,5	100	4	39	40	85,90
Corsa-E Van	1.2/1.4		ab e1*2007/46*0505*09	S-D/Van	04.15-12.19	5 1/2 J x 14	175/70R14	185/70R14		14170	R1-1662	4250906816625	6515	OP514021		56,5	100	4	39	54	72,60

Corsa-E Van	1.2/1.3CDTi/1.4	ab e1*2007/46*0505*09, ab e1*2007/46*055*05	S-D/Van/-V	04.15-12.19	6J x15	185/65R15			15193	R1-1648	4250906816489	6445	OP515024	56,5	100	4	39	40	85,90
Meriva-B Van	1.7CDTi	e4*2007/46*0271*	S-D/Monocab B/V	01.11-	6½J x16	195/60R16	205/55R16		16057	R1-1560	4250906815604	9045	OP516007	65	110	5	37	40	107,30
Movano II	2.3CDTi	e1*2007/46*0362*, -/405*, -/471*, -/579*, -/580*	MR/MS/MT/MW/MV	03.10-12.21	6½J x16	215/65R16	225/65R16	235/65R16	16147	R1-1765	4250906817653	9133	RE616012	89	130	5	66	30	126,00
Movano II	2.3CDTi	e1*2007/46*0362*, -/405*, -/471*, -/472*	MR/MS/MT/MU	03.10-12.21	5½J x16	195/75R16			16148	R1-1799	4250906817998	8733	RE616015	142,1	200	6	110	30	170,50
Movano III Cargo	2.2d	e3*2007/46*0045*22	Y/H	01.22-	6J x15	215/70R15	225/70R15		15273	R1-1908	4250906819084	4011	FL615007	71,1	118	5	68	40	108,90
Movano III Cargo/ Movano-e Cargo	2.2d/Movano-e Cargo Elektro (100kW)	e3*2007/46*0045*22, ab e2*2007/0045*22, ab e2*2007/46*0735*02, ab e3*2007/46*0050*24	Y/H	01.22-	6J x16	215/75R16	225/75R16		16209	R1-1910	4250906819107	7011	FL616009	78,1	130	5	68	30	133,90
Vivaro II	1.9D/1.9DTi/2.0i/2.0-D-CDTi/2.5DTi/2.5-CDTi	bis e1*98/14*0170*29, bis e1*2007/46*0575*11, K830, L048	X83/E7/F7	10.06-08.14	6J x16	195/65R16	205/65R16	215/65R16	16034	R1-1373	4250906813730	9506	RE616008	71	118	5	50	30	114,50
Vivaro III	1.6CDTi/1.6Biturbo CDTi	ab 2007/46*0575*12, ab e1*98/14*0170*30	F7/X83	09.14-04.19	6J x16	205/65R16	215/65R16		16202	R1-1896	4250906818964	7503	RE616016	66	114,3	5	50	30	111,90
Vivaro IV Cargo/ Vivaro-e Cargo	1.5d/2.0d/Elektro (100kW)	ab e2*2007/46*0533*08	V	05.19-	7J x16	215/65R16			16237	R1-1980	4250906819800	7505	PS616003	65	108	5	46	30	105,40
Vivaro IV Cargo/ Vivaro-e Cargo	1.5d/2.0d/Elektro (100kW)	ab e2*2007/46*0533*08	V	05.19-	7J x17	215/60R17	225/55R17		17035	R1-2046	4250906820462	9026		65	108	5	46	25	136,20
Zafira-B Van	1.6CNG-Turbo/1.7CDTi	e1*2007/46*0595*	A-H/Monocab/V	01.11-	6½J x16	195/60R16	205/55R16		16057	R1-1560	4250906815604	9045	OP516007	65	110	5	37	40	107,30

Modell- bezeichnung	Motorvarianten	Bemerkungen	ABE-Nummer	Fahrzeugtyp	Bauzeit von/bis	Radab- messung	Reifengröße	MWD- Nr.	MW-AM Nr.	EAN-Nr.	Alcar- Nr.	KPZ- Nr.	Bemerk.	Anschlussmaße				Stk. p.Pal.	Preis in € exkl. MwSt.
Car model	Motorversion	General remarks	ABE-Number	Project Code	Production year	Wheel Size	Tyre Size	MWD- Ref.	MW-AM Ref.	EAN-Nr.	Alcar- Ref.	KPZ- Ref.	Remarks	Center hole	Pitch circle diameter	Techn. Connection Hole number	Offset in mm	Qty. p.Pal.	Price in € without TVA

Peugeot

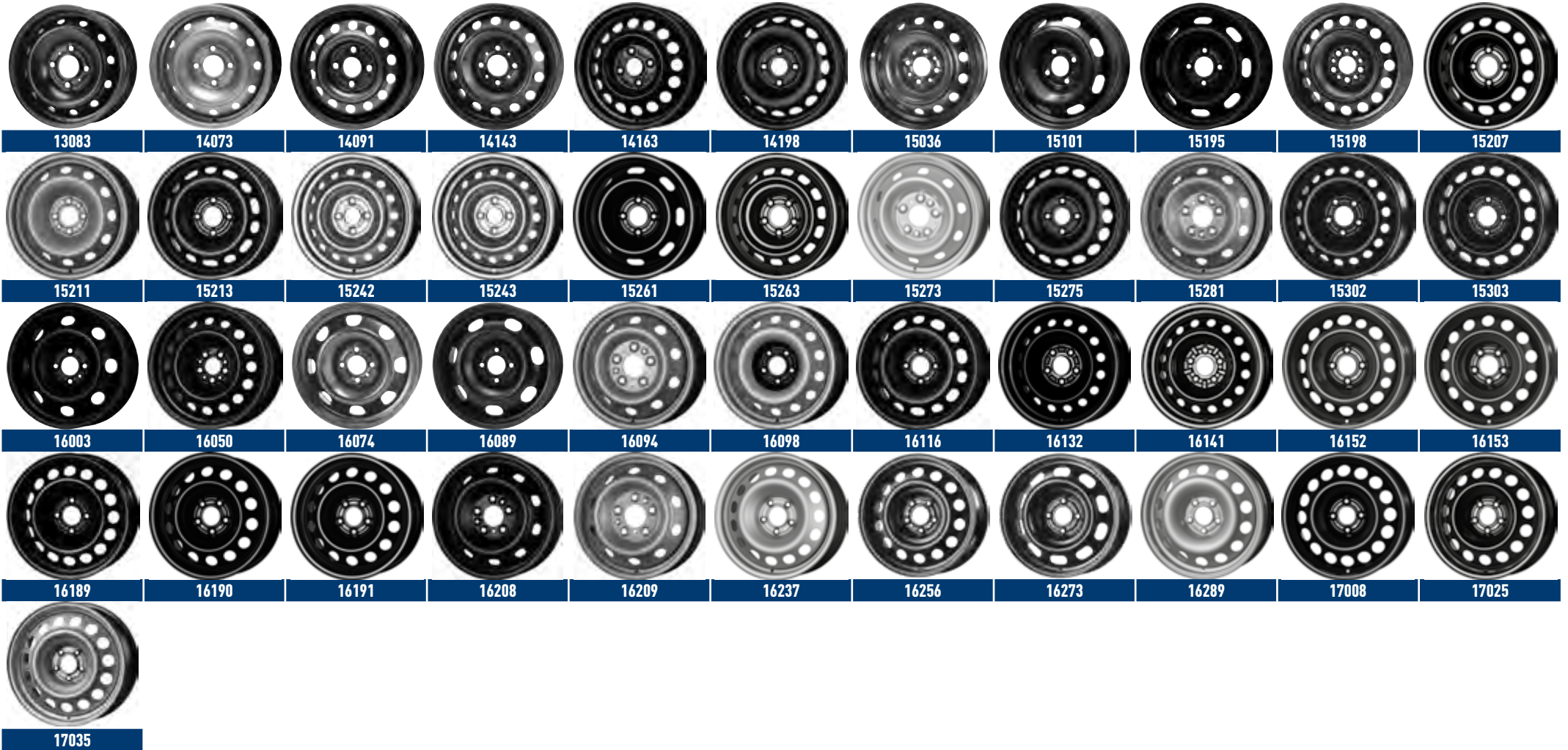

107	1.0i/1.4HDi	bis e11*2001/116*0237*10	P/P*****	08.05-06.14	4 1/2 J x 14	155/65R14													14163	R1-1601	4250906816014	4940	T0514017	54	100	4	39	63	83,10
108	68VTi/82VTi	ab e11*2001/116*0237*11, e6*2007/46*0350*	P/P*****	07.14-	4 1/2 J x 14	165/65R14													14198	R1-1930	4250906819305	5770	T0514021	54	100	4	35	63	80,30
108	68VTi/82VTi	ab e11*2001/116*0237*11, e6*2007/46*0350*	P/P*****	07.14-	4 1/2 J x 15	165/60R15													15275	R1-1931	4250906819312	7510	T0515019	54	100	4	35	56	95,70

Modell- bezeichnung	Motorvarianten	Bemerkungen	ABE-Nummer	Fahrzeugtyp	Bauzeit von/bis	Radab- messung	Reifengröße	MWD- Nr.	MW-AM Nr.	EAN-Nr.	Alcar- Nr.	KPZ- Nr.	Bemerk.	Anschlussmaße				Stk. p.Pal.	Preis in € exkl. MwSt.
Car model	Motorversion	General remarks	ABE-Number	Project Code	Production year	Wheel Size	Tyre Size	MWD- Ref.	MW-AM Ref.	EAN-Nr.	Alcar- Ref.	KPZ- Ref.	Remarks	Techn. Connection				Qty. p.Pal.	Price in € without TVA
														Center hole	Pitch circle diameter	Hole number	Offset in mm		

Peugeot (Fortsetzung)

307/SW/Break	1.4i/1.4Hdi/1.6i-16V/1.6Hdi-FAP/2.0i/2.0Hdi/2.0H-Di-FAP		e2*98/14*0242*, -/243*, -/245*, -/251*, e2*2001/116*0243*, -/287*, -/288*, -/299*, -/301*, -/333*	3*NFU/RHY/KFW/8HZ/ KFU/9HY/9HZ/9HX/9HV	09.01-12.08	6J x 15	195/65R15	15101	R1-1372	4250906813723	8690	PS515037		65	108	4	27	40	91,30
307/SW/Break/CC	1.4Hdi/1.6i-16V/1.6Hdi-FAP/2.0i/2.0Hdi/2.0Hdi-FAP		e2*98/14*0243*, -/244*, -/245*, -/251*, -/252*, e2*2001/116*0235*, -/243*, -/287*, -/299*, -/301*, -/313*, -/333*	3*NFU/RFN/RHY/8HZ/ RHS/9HY/RHR/RFK/9HZ/9HX/ RFJ/9HV	09.01-12.08	6 1/2 J x 16	205/55R16	16074	R1-1582	4250906815826	9695	PS516003		65	108	4	31	30	106,50
308/SW/CC	1.4VTi/1.6VTi/1.6Hdi/2.0Hdi / CC 1.6Hdi		e2*2001/116*0362*	4/4*****	10.07-12.13	6 1/2 J x 15	195/65R15	15207	R1-1700	4250906817004	7815	PS515048		65	108	4	27	40	91,80
308/SW/CC	1.4VTi/1.6VTi/1.6THP/1.6Hdi/2.0Hdi		e2*2001/116*0362*	4/4*****	10.07-12.13	7 J x 16	205/55R16	16116	R1-1701	4250906817011	9783	PS516015		65	108	4	32	30	107,90
308/SW	1.2THP/1.2VTi/1.6VTi/1.6Hdi		e2*2007/46*0405*	L	10.13-	6 1/2 J x 15	195/65R15	15263	R1-1881	4250906818810	7823	PS515053		65	108	5	42	40	89,10
308/SW	1.2THP/1.2VTi/1.6VTi/1.6Hdi/2.0Hdi/2.0GT-Hdi		e2*2007/46*0405*	L	10.13-	7 J x 16	205/55R16	16191	R1-1882	4250906818827	9833	PS516023		65	108	5	44	30	105,10
308 III	1.2 PureTech 110/130/1.5 Hdi130/1.6		ab e2*2007/46*0628*13	F	06.21-	7 J x 16	205/55R16	16191	R1-1882	4250906818827	9833	PS516023		65	108	5	44	30	105,10
308/308SW	Hdi130/Hybrid 180/225/PureTech 110/130		ab e2*2007/46*0628*13	F	01.22-	7 J x 16	205/55R16	16191	R1-1882	4250906818827	9834			65	108	5	44	30	105,10
3008	1.2THP/1.6THP/1.6VTi/1.6Hdi/2.0Hdi/Hybrid		e2*2001/116*0377*, e2*2007/46*0094*	OU/OU****/HU	10.07-10.16	7 J x 16	215/60R16	16116	R1-1701	4250906817011	9783	PS516015		65	108	4	32	30	107,90
3008	1.2THP/1.6THP/1.6VTi/1.6Hdi/2.0Hdi/Hybrid/4x4		e2*2001/116*0377*, e2*2007/46*0094*	OU/OU****/HU	06.09-10.16	7 1/2 J x 17	225/50R17	17008	R1-1778	4250906817783	9943			65	108	4	29	25	131,90
3008 II	1.2/1.6Hdi/1.6THP/2.0Hdi		e2*2007/46*0534*	M	11.16-	7 J x 17	215/65R17	17025	R1-1996	4250906819961	9036	PS517006		65	108	5	42	25	115,90
406	1.6i/1.8i/1.8i-16V/1.9TD/2.0Hdi/2.1TD/TDi/2.0i-16V/2.0 turbo		e2*93/81*0023*, bis -/29*, -/73*, -/87*, -/88*, -/155*, -/188*, e2*98/14*0024*, -/25*, -/26*, -/87*, -/88*, -/92*, -/155*, -/188*, -/223*, -/222*, -/264*	8*BFZ/RFV/LFY/DHX/P8C/ RGX/LFX/RFN/DHW/LFX/D8B/ RHZ/RHY/RFV/RFV/RHS	11.95-03.04	6J x 15	195/65R15	15036	R1-1334	4250906813341				65	108	4	18	40	88,20
406	1.6i/1.8i/1.8i-16V/1.9TD/2.0Hdi/2.1TD/TDi/2.0i-16V/2.0 turbo		e2*93/81*0023*, bis -/29*, -/73*, -/87*, -/88*, -/155*, -/188*, e2*98/14*0024*, -/25*, -/26*, -/87*, -/88*, -/92*, -/155*, -/188*, -/223*, -/222*, -/264*	8*BFZ/RFV/LFY/DHX/P8C/ RGX/DHW/LFX/D8B/RFN/ DHW/LFX/D8B/RHZ/RHY/RFV/ RFV/RHS	11.95-03.04	6J x 15	195/65R15	15180	R1-1087	4250906810876	8470	PS515022		65	108	4	18	40	102,70
4007	2.2Hdi-FAP/2.4-16V		e2*2001/116*0357*	VN*****	09.07-07.12	6 1/2 JJ x 16	215/70R16	16132	R1-1753	4250906817530	9407	MT516003		67	114,3	5	38	30	129,80
4008	1.6/1.6Hdi-115/1.8Hdi-150		e2*2007/46*0115*	B	08.12-12.17	6 1/2 JJ x 16	215/70R16	16141	R1-1880	4250906818803	9657	PS516020		67	114,3	5	38	30	129,80
508/SW	1.6THP/1.6VTi/1.6Hdi/2.0Hdi		e2*2007/46*0080*	8	05.11-05.18	7 J x 16	215/60R16	16153	R1-1782	4250906817820	9983	PS516019		65	108	5	47	30	111,50
508/SW II	Hdi-130/Puretech-180		e2*2007/46*0628*	F	06.18-	7 J x 16	215/60R16	16256	R1-2041	4250906820417	8983			65	108	5	40	30	105,20
5008 II	PureTech-130(1.2)/THP-165(1.6)/Hdi-120(1.6)/Hdi-150/-180(2.0)		e2*2007/46*0534*	M	04.17-	7 J x 17	215/65R17	17025	R1-1996	4250906819961	9036	PS517006		65	108	5	42	25	115,90
807	2.0D/2.0Hdi/2.0i-16V/2.2Hdi/2.2i-16V		e2*98/14*0253*	E/E*****	09.02-	7 J x 16	215/60R16	16050	R1-1470	4250906814706	9417			58	98	5	27	30	114,70
Bipper Tepee	1.3Hdi/1.4i/1.4Hdi		e3*2001/116*0272*, e3*2007/46*0012*	A/A*****	02.08-12.15	6J x 15	185/65R15	15211	R1-1681	4250906816816	7680	FL515013		58	98	4	44	40	100,30

Boxer Kombi	270C/310C/320M 1.9DT/2.0i/2.5D/2.8HDI / 320MH 2.5D/2.8HDI/350LH 2.8HDI	Radlast 1.000 kg	G716, G717, G718, G828, e3*96/27*0026*	23/230L/230D/230P	05.95-03.02	6J x15	195/70R15	205/70R15	215/70R15	15273	R1-1908	4250906819084	4011	FL615007	71,1	118	5	68	40	108,90
Boxer Kombi	270C/310C/320M 1.9DT/2.0i/2.5D/2.8HDI / 320MH 2.5D/2.8HDI/350LH 2.8HDI	Radlast 1.000 kg	G716, G717, G718, G828, e3*96/27*0026*	23/230L/230D/230P	05.95-03.02	6J x15	195/70R15	205/70R15	215/70R15	15281	R1-1941	4250906819411	4012	FL615007	71,1	118	5	68	40	108,90
Boxer Kombi	290C/2.0HDI/2.2HDI/2.8HDI/4x4 / 330M/330M-H/2.0i/2.0HDI/2.2HDI/2.8HDI/4x4	Radlast 1.000 kg	e3*98/14*0103*	Z	04.02-09.06	6J x15	195/70R15	205/70R15		15273	R1-1908	4250906819084	4011	FL615007	71,1	118	5	68	40	108,90
Boxer Kombi	290C/2.0HDI/2.2HDI/2.8HDI/4x4 / 330M/330M-H/2.0i/2.0HDI/2.2HDI/2.8HDI/4x4	Radlast 1.000 kg	e3*98/14*0103*	Z	04.02-09.06	6J x15	195/70R15	205/70R15		15281	R1-1941	4250906819411	4012	FL615007	71,1	118	5	68	40	108,90
Boxer II Kombi	2.2HDI-100/2.2HDI-120/3.0HDI-160	Radlast 1.000 kg	bis e3*2001/116*0233*10, bis e3*2007/46*0045*08	Y	10.06-03.14	6J x15	205/70R15	215/70R15	225/70R15	15273	R1-1908	4250906819084	4011	FL615007	71,1	118	5	68	40	108,90
Boxer II Kombi	2.2HDI-100/2.2HDI-120/3.0HDI-160	Radlast 1.000 kg	bis e3*2001/116*0233*10, bis e3*2007/46*0045*08	Y	10.06-03.14	6J x15	205/70R15	215/70R15	225/70R15	15281	R1-1941	4250906819411	4012	FL615007	71,1	118	5	68	40	108,90
Boxer II Kombi	2.2HDI-120/3.0HDI	Radlast 1.280 kg	bis e3*2001/116*0233*10	Y	10.06-03.14	6J x16	215/75R16	225/75R16		16209	R1-1910	4250906819107	7011	FL616009	78,1	130	5	68	30	133,90
Boxer III Kombi	2.2HDI-120/140	Radlast 1.000 kg	ab e3*2001/116*0233*16	Y	04.14-	6J x15	215/70R15	225/70R15		15273	R1-1908	4250906819084	4011	FL615007	71,1	118	5	68	40	108,90
Boxer III Kombi	2.2HDI-120/140	Radlast 1.000 kg	ab e3*2001/116*0233*16	Y	04.14-	6J x15	215/70R15	225/70R15		15281	R1-1941	4250906819411	4012	FL615007	71,1	118	5	68	40	108,90
Boxer III Kombi	2.2HDI-120/140	Radlast 1.100 kg	ab e3*2001/116*0233*16	Y	04.14-	6J x16	215/75R16	225/75R16		16208	R1-1909	4250906819091	6011	FL616008	71,1	118	5	68	25	141,60
Expert I Kombi	2.0i-16V/2.0HDI		e2*2001/116*0185*	B/B*****	03.04-01.07	6 1/2 J x15	205/65R15			15198	R1-1643	4250906816434	9385	PS615001	58	98	5	31	40	105,40
Expert II Tepee	1.6HDI-90/2.0HDI-120/2.0HDI-135-FAP/2.0B-140		e2*2001/116*0349*, e2*2007/46*0046*	X/X*****	02.07-12.16	7J x16	215/60R16			16098	R1-1675	4250906816755	7780	PS616001	65	108	5	42	30	118,40
Expert Traveller/ e-Traveller	1.5HDI100/1.6-HDI95/115/2.0-HDI120/150/180/Elektro (100kW)		e2*2007/46*0532*	V	06.16-	7J x16	215/65C16			16237	R1-1980	4250906819800	7505	PS616003	65	108	5	46	30	105,40
Expert Traveller/ e-Traveller	1.5HDI100/1.6-HDI95/115/2.0-HDI120/150/180/Elektro (100kW)		e2*2007/46*0532*	V	06.16-	7J x17	215/60R17	225/55R17		17035	R1-2046	4250906820462	9026		65	108	5	46	25	136,20
iOn	Elektro (49kW)	nur für Vorderachse	e2*2007/46*0069*	1	01.11-	4J x15	145/65R15			15242	R1-1805	4250906818056	7160	PS515049	56	100	4	35	48	115,70
iOn	Elektro (49kW)	nur für Hinterachse	e2*2007/46*0069*	1	01.11-	5J x15	175/55R15			15243	R1-1806	4250906818063	7235	PS515050	54	100	4	35	48	115,00
Partner I Kombi	1.1i/1.4i/1.6i/1.8i/1.9D/2.0HDI		e2*93/81*0060*,-/61*,-/162*,-/133*,-/182*, e2*98/14*0060*,-/61*,-/133*,-/182*,-/202*,-/228*,-/229*,-/230,-/231*	5*HDZ/DJY/WJZ/KFX/LFX/RHY/KFW/NFU/WJY	03.96-03.03	5 1/2 J x14	175/65R14	175/70R14		14073	R1-1278	4250906812788	6395	PS614002	65	108	4	24	54	86,30
Partner I Kombi	1.4i/1.6HDI/1.9D/2.0HDI		e2*2001/116*0279*, -/281*, -/282*, -/322, -/338*	6*KFW/WJY/RHY/9HX/9HW	04.03-12.08	5 1/2 J x14	175/70R14			14073	R1-1278	4250906812788	6395	PS614002	65	108	4	24	54	86,30
Partner II Tepee	1.6-16V/1.6HDI/Electrique (49kW)		e2*2001/116*0365*, e2*2007/46*0001*	7/7*****	07.08-12.18	6 1/2 J x15	195/65R15	195/70R15	205/65R15	15213	R1-1735	4250906817356	8477	PS615003	65	108	4	27	40	97,60
Partner II Tepee	1.6-16V/1.6HDI		e2*2001/116*0365*, e2*2007/46*0001*	7/7*****	07.08-12.18	6 1/2 J x16	215/55R16			16089	R1-1663	4250906816632	7860	PS516012	65	108	4	26	30	105,90
Rifter L1	1.2-PureTech 110/1.5HDI-75/100		e2*2007/46*0624*	E	09.18-	6 1/2 J x15	195/65R15			15302	R1-2056	4250906820561	5477	PS615004	65	108	5	42	40	102,60
Rifter L1/L2	1.2-PureTech 110/1.5HDI-75/100/130	Radlast 610 kg	e2*2007/46*0624*	E	09.18-	6 1/2 J x16	205/60R16	215/65R16		16190	R1-1887	4250906818872	7460	PS616004	65	108	5	47	30	108,30
e-Rifter L1/L2	e-Rifter Elektroantrieb (100kW)		ab e2*2007/46*0624*13	E	09.21-	6 1/2 J x16	205/60R16	215/65R16		16289	R1-2094	4250906820943	7461	PS616004	65	108	5	47	30	108,30
Traveller Crosscamp	Hdi/120/145/150/EATB-145/170		e1*2007/46*2079*	EG/DK0002	01.20-	7J x17	215/60R17	225/55R17		17035	R1-2046	4250906820462	9026		65	108	5	46	25	136,20

Modellbezeichnung	Motorvarianten	Bemerkungen	ABE-Nummer	Fahrzeugtyp	Bauzeit von/bis	Radabmessung	Reifengröße	MWD-Nr.	MW-AM Nr.	EAN-Nr.	Alcar-Nr.	KPZ-Nr.	Bemerk.	Anschlussmaße				Stk. p.Pal.	Preis in € exkl. MwSt.
Car model	Motorversion	General remarks	ABE-Number	Project Code	Production year	Wheel Size	Tyre Size	MWD-Ref.	MW-AM Ref.	EAN-Nr.	Alcar-Ref.	KPZ-Ref.	Remarks	Techn. Connection				Qty. p.Pal.	Price in € without TVA
														Center hole	Pitch circle diameter	Hole diameter	Offset in mm		

Peugeot Nfz.

Bipper	1.3HdI/1.4i/1.4HdI		N127, e3*2007/46*0012*	225L/A	02.08-12.15	6J x 15	185/65R15			15211	R1-1681	4250906816816	7680	FL515013	58	98	4	44	40	100,30
Boxer I	270C/270CS 1.9D/1.9DT/2.0i/310C/310CS 2.0i/2.5D/2.8HdI/320 M 2.0i/2.5D/2.8HdI/320MH/320LH 2.0i/2.5D/2.8HdI	Radlast 1.000 kg	G716, G717, G718, G828	230/230L/230D/230P	03.94-03.02	6J x 15	195/70R15	205/70R15		15273	R1-1908	4250906819084	4011	FL615007	71,1	118	5	68	40	108,90
Boxer I	270C/270CS 1.9D/1.9DT/2.0i/310C/310CS 2.0i/2.5D/2.8HdI/320 M 2.0i/2.5D/2.8HdI/320MH/320LH 2.0i/2.5D/2.8HdI	Radlast 1.000 kg	G716, G717, G718, G828	230/230L/230D/230P	03.94-03.02	6J x 15	195/70R15	205/70R15		15281	R1-1941	4250906819411	4012	FL615007	71,1	118	5	68	40	108,90
Boxer I (Facelift)	330C/CS/330M/330L/2.0HdI/2.2HdI/2.8HdI/2.0iBipower/4x4	Radlast 1.000 kg	K912, K913, K914, L113	244/244D/244L/244M	04.02-09.06	6J x 15	195/70R15	205/70R15		15273	R1-1908	4250906819084	4011	FL615007	71,1	118	5	68	40	108,90
Boxer I (Facelift)	330C/CS/330M/330L/2.0HdI/2.2HdI/2.8HdI/2.0iBipower/4x4	Radlast 1.000 kg	K912, K913, K914, L113	244/244D/244L/244M	04.02-09.06	6J x 15	195/70R15	205/70R15		15281	R1-1941	4250906819411	4012	FL615007	71,1	118	5	68	40	108,90
Boxer II	2.2HdI-100/2.2HdI-120/3.0HdI-160	Radlast 1.000 kg	L771, L772, L936	250/250D/250L	10.06-06.11	6J x 15	215/70R15	225/70R15		15273	R1-1908	4250906819084	4011	FL615007	71,1	118	5	68	40	108,90
Boxer II	2.2HdI-100/2.2HdI-120/3.0HdI-160	Radlast 1.000 kg	L771, L772, L936	250/250D/250L	10.06-06.11	6J x 15	215/70R15	225/70R15		15281	R1-1941	4250906819411	4012	FL615007	71,1	118	5	68	40	108,90
Boxer II	2.2HdI/3.0HdI	Radlast 1.280 kg	L771, L772, L936	250/250D/250L	10.06-06.11	6J x 16	215/75R16	225/75R16		16209	R1-1910	4250906819107	7011	FL616009	78,1	130	5	68	30	133,90
Boxer II (Facelift)	2.2HdI/3.0HdI	Radlast 1.000 kg	bis e3*2007/46*0045*09, bis e3*2007/46*0050*07	Y	07.11-03.14	6J x 15	215/70R15	225/70R15		15273	R1-1908	4250906819084	4011	FL615007	71,1	118	5	68	40	108,90
Boxer II (Facelift)	2.2HdI/3.0HdI	Radlast 1.000 kg	bis e3*2007/46*0045*09, bis e3*2007/46*0050*07	Y	07.11-03.14	6J x 15	215/70R15	225/70R15		15281	R1-1941	4250906819411	4012	FL615007	71,1	118	5	68	40	108,90
Boxer II (Facelift)	2.2HdI/3.0HdI	Radlast 1.280 kg	bis e3*2007/46*0045*09, bis e3*2007/46*0050*07	Y	07.11-03.14	6J x 16	215/75R16	225/75R16		16209	R1-1910	4250906819107	7011	FL616009	78,1	130	5	68	30	133,90
Boxer III	2.0HdI/2.2HdI/3.0HdI	Radlast 1.000 kg	ab e3*2001/116*0233*12, ab e3*2007/46*0045*10	Y	04.14-	6J x 15	215/70R15	225/70R15		15273	R1-1908	4250906819084	4011	FL615007	71,1	118	5	68	40	108,90
Boxer III	2.0HdI/2.2HdI/3.0HdI	Radlast 1.000 kg	ab e3*2001/116*0233*12, ab e3*2007/46*0045*10	Y	04.14-	6J x 15	215/70R15	225/70R15		15281	R1-1941	4250906819411	4012	FL615007	71,1	118	5	68	40	108,90
Boxer III	2.0HdI/2.2HdI/3.0HdI	Radlast 1.100 kg	ab e3*2001/116*0233*12, ab e3*2007/46*0045*10	Y	04.14-	6J x 16	215/75R16	221/75R16		16208	R1-1909	4250906819091	6011	FL616008	71,1	118	5	68	25	141,60
Boxer III	2.0HdI/2.2HdI/3.0HdI	Radlast 1.280 kg	ab e3*2001/116*0233*12, ab e3*2007/46*0045*10, ab e2*2007/46*0050*08	Y	04.14-	6J x 16	215/75R16	225/75R16		16209	R1-1910	4250906819107	7011	FL616009	78,1	130	5	68	30	133,90
Expert I (Facelift)	1.9D/2.0i-16V/2.0HdI		H174	222	03.04-01.07	6 1/2 J x 15	195/65R15	205/65R15		15198	R1-1643	4250906816434	9385	PS615001	58	98	5	31	40	105,40
Expert II	1.6HdI-90/2.0HdI-120/2.0HdI-135-FAP/2.0B-140		L867	G9	02.07-12.16	7J x 16	215/60R16			16098	R1-1675	4250906816755	7780	PS616001	65	108	5	42	30	118,40
Expert III/e-Expert III	1.5HdI100/120/1.6-HdI95/115/2.0HdI120/150/180/Elektro (100kW)		e2`*2007/46*0533*	V	08.16-	7J x 16	215/65C16			16237	R1-1980	4250906819800	7505	PS616003	65	108	5	46	30	105,40
Expert III/e-Expert III	1.5HdI100/120/1.6-HdI95/115/2.0HdI120/150/180/Elektro (100kW)		e2`*2007/46*0533*	V	08.16-	7J x 17	215/60R17			17035	R1-2046	4250906820462	9026		65	108	5	46	25	136,20

Partner I	170C 1.1i/1.4i/1.6i/1.9D/2.0HDI/190 C 1.4i/1.9D/2.0HDi		e2*93/81*0060*, -/61*, -/62*, -/133*, -/182*, e2*98/14*0060*, -/61*, -/133*, -/182*, -/202*, -/228*, -/229*, -/230*, -/231*, H420	5/5*HDZ/DJY/WJZ/KFX/LFX/WJZ/RHY/HFX/KFW/NFU/WJY	03.96-03.03	5 1/2 J x 14	165/70R14	175/65R14	175/70R14	14073	R1-1278	4250906812788	6395	PS614002	65	108	4	24	54	86,30
Partner I	170C/190C/1.1i/1.4i/1.6i-16V/1.9D/2.0HDi		L083, L162, L163	M59/M59GL/M59GN	04.03-12.08	5 1/2 J x 14	175/65R14			14073	R1-1278	4250906812788	6395	PS614002	65	108	4	24	54	86,30
Partner II	1.6-16V/1.6HDi		N128	B9	07.08-12.18	6 1/2 J x 15	195/65R15	195/70R15		15213	R1-1735	4250906817356	8477	PS615003	65	108	4	27	40	97,60
Partner III L1	1.2-PureTech 110/1.5HDi-100/1.6HDi-75/100		e2*2007/46*0625*	E	09.18-	6 1/2 J x 15	195/65R16			15302	R1-2056	4250906820561	5477	PS615004	65	108	5	42	40	102,60
Partner III/Rifter/L1/L2	1.2-PureTech 110/1.5HDi-100/130/1.6HDi-75/100	Radlast 610 kg	e2*2007/46*0624*	E	09.18-	6 1/2 J x 16	205/60R16	215/65R16		16289	R1-2094	4250906820943	7461	PS616004	65	108	5	47	30	108,30

Piaggio

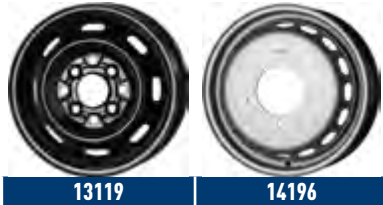

13119

14196

Ape					-	400B x 12				12013	R1-1749	4250906817493								
Porter		silber			-	4 1/2 J x 13				13119	R1-1798	4250906817981			66,5	110	4	50	63	96,80
Porter			e11*2007/46*0031*	S90	-	4,50B x 14	165/65R14			14196	R1-1875	4250906818759			110	139,7	5	90	64	98,80

Clio III/Grandtour	1.2i-16V	e2*2001/116*0327*	R	09.05-06.13	5½J x 15	165/65R15				15178	R1-1579	4250906815796	7935	RE515020	60	100	4	43	48	99,90
Clio III/Grandtour	1.2i-16V/1.5dCi/1.4i-16V/1.6i-16V/2.0i-16V	e2*2001/116*0327*	R	09.05-06.13	6J x 15	175/65R15	185/60R15			15179	R1-1580	4250906815802	7965	RE515021	60	100	4	50	40	101,90
Clio III/Grandtour	1.2i-16V/1.5dCi/1.4i-16V/1.6i-16V/2.0i-16V	e2*2001/116*0327*	R	09.05-06.13	6J x 15	185/60R15	185/65R15			15189	R1-1611	4250906816113	7715		60	100	4	43	40	108,20
Clio IV/Grandtour	0.9-TCe90/1.2-16V-65/75/120/1.5-dCi-75/90/110	ab e2*2001/116*0327*46*, e2*2007/46*0008*	R	11.12-	6J x 15	185/65R15				15253	R1-1855	4250906818551	7777	RE515027	60	100	4	40	40	94,90
Clio V	dCi85/115/SCe65/75/TCe100/130/e-Tech Hybrid	e2*2007/46*0676*	RJA	10.19-	6J x 15	185/65R15				15301	R1-2045	4250906820455	4444		60	100	4	31	48	96,80
Clio V	dCi85/115/SCe65/75/TCe100/TCe100/130/e-Tech Hybrid	e2*2007/46*0676*	RJA	10.19-	6½J x 16	195/55R16				16282	R1-2075	4250906820752	6666		60	100	4	37	30	105,70
Espace/Grand Espace	1.9dCi/2.0i-16V/2.0T/2.0dCi/2.2dCi/3.0dCi/3.5V6	e2*98/14*0265*	K	10.02-03.15	7J x 17	225/55R17				17003	R1-1429	4250906814294	9135	RE517004	60	108	5	50	25	145,90
Espace	dCi130-1.6/dCi160-1.6/TCe200-1.6	e2*2007/46*0470*	RFC	04.15-	7J x 17	235/65R17				17019	R1-1946	4250906819466	9006	RE517005	66	114,3	5	37	20	132,80
Fluence	1.5dCi/1.6-16V/2.0-16V	e2*2001/116*0373*	Z	06.10-12.14	6½J x 15	205/65R15				15215	R1-1734	4250906817349	7306	RE515026	66	114,3	5	43	40	105,30
Fluence	1.5dCi/1.6-16V/2.0-16V	e2*2001/116*0373*	Z	06.10-12.14	6½J x 16	205/60R16				16122	R1-1732	4250906817325	9563	RE516013	66	114,3	5	47	30	102,70
Fluence Z.E.	Elektrofahrzeug (70kW)	e2*2007/46*0090*	LZ	02.12-12.14	6½J x 16	205/55R16				16122	R1-1732	4250906817325	9563	RE516013	66	114,3	5	47	30	102,70
Kadjar/Kadjar XMOD	dCi110/dCi130/TCe130/TCe160	e2*2007/46*0475*	RFE	04.15-	6½JJ x 16	215/65R16				16201	R1-1897	4250906818971	7856	NI516005	66	114,3	5	40	30	106,90
Kangoo	1.2i/1.2i-16V/1.4i/1.5dCi/1.9D/1.9dTi	e2*93/81*0164*, e2*98/14*0164*	KC	04.98-12.09	5½J x 14	165/70R14	165/75R14	175/65R14		14084	R1-1132	4250906811323	6530	RE514009	60	100	4	36	54	85,40
Kangoo II	1.2TCE/1.5dCi/1.6-8V/1.6-16V/1.6LPG	e2*2001/116*0364*, e2*2007/46*0006*	W	02.08-	6J x 15	195/65R15				15214	R1-1712	4250906817127	7215	RE515023	60	108	5	44	40	101,70
Kangoo III	dCi75/dCi95/TCe100/TCe130	e2*2018/858*00001*	RFK	03.21-	6J x 15	195/65R15				15313	R1-2099	4250906820998	4517		66	114,3	5	35	40	99,70
Kangoo III	dCi75/dCi95/TCe100/TCe130	e2*2018/858*00001*	RFK	03.21-	6J x 16	205/60R16				16293	R1-2112	4250906821124	6516		66	114,3	5	38	30	109,60
Laguna II/Grandtour	1.6i-16V/1.8i-16V/1.9dCi/2.0i-16V/2.0dCi/2.2dCi/3.0iV6-24V/Automatic	e2*98/14*0206*	G	03.01-09.07	6½J x 16	205/55R16	205/60R16			16027	R1-1187	4250906811873	9435	RE516009	60	108	5	50	30	103,90
Laguna III/Grandtour	1.5dCi/1.6-16V/2.0-16V/2.0dCi	e2*2001/116*0363*	T	10.07-06.15	7J x 16	205/60R16	215/55R16	215/60R16		16114	R1-1670	4250906816700	9583	RE516015	66	114,3	5	47	30	115,10
Latitude	2.0-16V/2.0dCi	e2*2001/116*0363*	T	10.10-12.12	7J x 16	195/60R16	205/60R16	215/55R16		16114	R1-1670	4250906816700	9583	RE516015	66	114,3	5	47	30	115,10
Megane	Limousine/Classic 1.4i-16V/1.6i-16V/1.6e/Cabrio/Coupé 1.4i-16V/1.6e	e2*93/81*0009*, -/10*, -/72*, -/103*, e2*98/14*0009*, -/10*, -/72*, -/103*	BA/DA/LA/EA	01.96-10.02	5½J x 14	175/65R14	175/70R14	185/60R14		14084	R1-1132	4250906811323	6530	RE514009	60	100	4	36	54	85,40
Megane Break	1.4i-16V/1.9dTi	e2*98/14*0192*	KA	01.99-05.03	5½J x 14	175/70R14				14084	R1-1132	4250906811323	6530	RE514009	60	100	4	36	54	85,40
Megane Scenic	1.6i/1.6eRN/RT	e2*93/81*0068*, e2*98/14*0068*	JA	01.97-07.98	5½J x 14	175/70R14				14084	R1-1132	4250906811323	6530	RE514009	60	100	4	36	54	85,40
Megane II	1.4i-16V/1.5dCi/1.6i-16V/1.9dCi/Cabrio 1.6i-16V/1.9dCi	e2*98/14*0272*	M	11.02-12.08	6½J x 15	195/65R15				15153	R1-1469	4250906814690	8715	RE515019	60	100	4	45	40	97,80
Megane II	1.4i-16V/1.5dCi/1.6i-16V/1.9dCi/2.0i-16V/2.0T-16V/Cabrio 1.6i-16V/1.9dCi/2.0i-16V/2.0T-16V	e2*98/14*0272*	M	11.02-12.08	6½J x 16	205/55R16				16038	R1-1468	4250906814683	9985	RE516010	60	100	4	49	30	104,20
Megane II Scenic	1.4i-16V/1.5dCi/1.6i-16V	e2*2001/116*0274*	JM	06.03-12.08	6½J x 15	195/65R15				15153	R1-1469	4250906814690	8715	RE515019	60	100	4	45	40	97,80
Megane II Scenic	1.4i-16V/1.5dCi/1.6i-16V/1.9dCi/2.0i-16V/2.0T-16V	e2*2001/116*0274*	JM	06.03-12.08	6½J x 16	205/55R16	205/60R16			16038	R1-1468	4250906814683	9985	RE516010	60	100	4	49	30	104,20

Modell- bezeichnung	Motorvarianten	Bemerkungen	ABE-Nummer	Fahrzeugtyp	Bauzeit von/bis	Radab- messung	Reifengröße			MWD- Nr.	MW-AM Nr.	EAN-Nr.	Alcar- Nr.	KPZ- Nr.	Bemerk.	Anschlussmaße				Stk. p.Pal.	Preis in € exkl. MwSt.	
Car model	Motorversion	General remarks	ABE-Number	Project Code	Production year	Wheel Size	Tyre Size			MWD- Ref.	MW-AM Ref.	EAN-Nr.	Alcar- Ref.	KPZ- Ref.	Remarks	Techn. Connection				Qty. p.Pal.	Price in € without TVA	
															Center hole	Pitch circle diameter	Hole number	Offset in mm				

Renault (Fortsetzung)

Megane III/Coupé/ Grandtour	1.2TCe/1.4TCe/1.5dCi/1.6-16V/2.0-16V/Coupé/Cabrio 1.4TCe/1.5dCi/1.6-16V/2.0-16V		e2*2001/116*0373*	Z	11.08-12.15	6 1/2 J x 15	195/65R15			15215	R1-1734	4250906817349	7306	RE515026		67	114,3	5	43	40	105,30
Megane III/Coupé/ Grandtour	1.4TCe/1.5dCi/1.6-16V/1.9dCi/2.0-16V/Coupé 1.4TCe/1.5dCi/1.6-16V/1.9dCi/2.0-16V		e2*2001/116*0373*	Z	11.08-12.15	6 1/2 J x 16	205/55R16	205/60R16		16122	R1-1732	4250906817325	9563	RE516013		67	114,3	5	47	30	102,70
Megane III Scenic	1.5dCi/1.6-16V	passt nicht auf Scenic und nicht auf X Mod.	e2*2001/116*0379*	JZ	06.09-12.15	6 1/2 J x 15	195/65R15			15215	R1-1734	4250906817349	7306	RE515026		67	114,3	5	43	40	105,30
Megane III Scenic/ Grand Scenic/ Xmod	1.4TCe/1.5dCi/1.6-16V/1.9dCi		e2*2001/116*0379*	JZ	06.09-12.15	6 1/2 J x 16	205/55R16	205/60R16		16122	R1-1732	4250906817325	9563	RE516013		67	114,3	5	47	30	102,70
Megane IV/ Grandtour	dCi110(1.5d)/TCe100(1.2)/TCe130(1.2)		e2*2007/46*0546*	RFB	12.15-	6 J x 15	195/65R15			15285	R1-1955	4250906819558	5020	RE515035		66	114,3	5	35	40	89,00
Megane IV/ Grandtour	dCi110(1.5d)/dCi130(1.6d)/TCe100(1.2)/TCe130(1.2) TCe160(1.3)		e2*2007/46*0546*	RFB	12.15-	6 1/2 J x 16	205/55R16			16222	R1-1956	4250906819565	7005	RE516021		66	114,3	5	41	30	105,90
Modus/Grand Modus	1.2i-16V		e2*2001/116*0319*	P	09.04-12.12	5 1/2 J x 15	165/65R15	185/60R15		15178	R1-1579	4250906815796	7935	RE515020		60	100	4	43	48	99,90
Modus/Grand Modus	1.2i-16V/1.5dCi/1.4i-16V/1.6i-16V		e2*2001/116*0319*	P	09.04-12.12	6 J x 15	175/75R15	185/60R15		15179	R1-1580	4250906815802	7965	RE515021		60	100	4	50	40	101,90
Scenic/Grand- Scenic	dCi95/dCi110/dCi130/dCi160/TCe115/TCe130/TCe140/ TCe160/TCe165		e2*2007/46*0574	RFA	08.16-	6 1/2 J x 20	195/55R20			20001	R1-1984	4250906819848	9981	RE520001		66	114,3	5	33	20	175,50
Talisman/ Grandtour	dCi110(1.5d)/dCi130(1.6d)		e11*2007/46*2969*, e2*2007/46*0653*	RFD	11.15-	6 1/2 J x 16	215/60R16			16222	R1-1956	4250906819565	7005	RE516021		66	114,3	5	41	30	105,90
Thalia/Symbol	1.2i-16V/1.4e/1.4i-16V/1.5dCi/1.6i-16V		e2*98/14*0126*	B	01.02-12.08	5 1/2 J x 14	175/65R14	185/60R14		14084	R1-1132	4250906811323	6530	RE514009		60	100	4	36	54	85,40
Twingo I	1.2i		G391, e2*93/81*0071*, e2*98/14*0071*	CO6	05.93-08.07	450B x 13	145/70R13	155/70R13		13041	R1-950	4250906809504	3440	RE513008		60	100	4	36	63	78,60
Twingo I	1.2i/1.2i-16V		e2*98/14*0071*	CO6	10.00-08.07	5 1/2 J x 14	155/65R14			14084	R1-1132	4250906811323	6530	RE514009		60	100	4	36	54	85,40
Twingo II	1.2/1.2-16V-TCE/1.2-16V-GT/1.5dCi1		e2*2001/116*0359*	N	10.07-08.14	5 1/2 J x 14	165/65R14	175/65R14		14175	R1-1637	4250906816373	7320	RE514020		60	100	4	29	54	86,40
Twingo III/e- Twingo	SCe70/TCe90/TCe110/e-Twingo electric (60kW)	Vorderachse	e2*2007/46*0457*	AH	09.14-	5 J x 15	165/65R15			15268	R1-1937	4250906819374	4001	RE515032		60	100	4	38	48	94,50
Twingo III/e- Twingo	SCe70/TCe90/TCe110/e-Twingo electric (60kW)	Hinterachse	e2*2007/46*0457*	AH	09.14-	5 1/2 J x 15	185/60R15			15269	R1-1938	4250906819381	4002	RE515033		60	100	4	36	48	93,60
Vel Satis	2.0i/2.0T/2.0dCi/2.2dCi/3.5i-V6/3.0dCi		e2*98/14*0263*, e2*98/14D0263*	J	10.02-12.09	7 J x 17	225/55R17			17003	R1-1429	4250906814294	9135	RE517004		60	108	5	50	25	145,90
Zoe	Zoe		e2*2007/46*0251*	AG	09.12-11.19	6 J x 15	185/65R15			15245	R1-1865	4250906818650				60	100	4	40	40	91,40
Zoe (Facelift)	R110 (80kW)/R135 (100kW)		ab e2*2007/46*0251*15, ab e2*2007/46*0681*03	AG	12.19-	6 J x 15	185/65R15			15305	R1-2081	4250906820813	4703			66	114,3	5	40	40	100,90

Renault Nfz.

Express	1.3TCe-100/1.5dCi-75/95		e2*2007/46*0717	RJK	03.21-	6 J x 15	185/65R15			15314	R1-2100	4250906821001	4516		66	114,3	5	40	40	98,80
Kangoo Rapid	1.2i/1.4i/1.9D		H984	FC	04.98-12.07	5,00B x 13	165/70R13			13068	R1-1303	4250906813037	4440	RE513015	60	100	4	36	54	69,80
Kangoo II Rapid	1.5dCi/1.6-8V		e2*2007/46*0006*	W	08.13-	6 J x 15	195/65R15			15262	R1-1894	4250906818940	7575	RE515028	60	100	4	44	40	118,10
Kangoo II Rapid	1.5dCi/1.6-8V/1.6-16V		N196	FW	02.08-	6 J x 15	195/65R15			15214	R1-1712	4250906817127	7215	RE515023	60	108	5	44	40	101,70
Kangoo II Z.E.	Elektro (44kW)		e2*2007/46*0089*	FW	12.11-	6 J x 15	195/65R15			15214	R1-1712	4250906817127	7215	RE515023	60	108	5	44	40	101,70
Kangoo III Rapid	dCi75/dCi95/TCe100/TCe130		e2*2018/858*00002*	RFK	03.21-	6 J x 15	195/65R15			15313	R1-2099	4250906820998	4517		66	114,3	5	35	40	99,70
Kangoo III Rapid	dCi75/dCi95/TCe100/TCe130		e2*2018/858*00002*	RFK	03.21-	6 J x 16	205/60R16			16293	R1-2112	4250906821124	6516		66	114,3	5	38	30	109,60
Master/Master Z.E.	2.3-100dCi/2.3-125dCi/2.3-150dCi/Elektro (57kW)		e2*2007/46*0016*,17*, -/18, -/19*, -/22*, -/348*	MA/MB/MC/ME/ML/MAEVA	05.10-	6 1/2 J x 16	215/65R16	225/65R16	235/65R16	16147	R1-1765	4250906817653	9133	RE616012	89	130	5	66	30	126,00
Master	2.3-125dCi/2.3-150dCi		e2*2007/46*0016*, -/17*, -/19*, -/20*	MA/MB/MC/MD	05.10-	5 1/2 J x 16	195/75R16			16148	R1-1799	4250906817998	8733	RE616015	142,1	200	6	110	30	170,50
Maxity	Dxi 2,5 / Dxi 3	Gianetti 15927	e9*2007/46*0035*	F241	05.07-	5 J x 15	195/70R15			15238	R1-1833	4250906818339		RE615005	130	170	5	106,5	40	114,50
Maxity	Dxi 2,5		e9*2007/46*0035*	F241	05.07-	5 J x 15	195/70R15			15289	R1-1972	4250906819725			130	170	6	106,5	40	114,60
Trafic II	1.9dCi/2.0dCi/2.0i-16V/2.5dCi		bis e2*98/14*0213*49, bis e2*2007/46*0014**22, K833	FL/JL/L	10.06-08.14	6 J x 16	195/65R16	205/65R16	215/65R16	16034	R1-1373	4250906813730	9506	RE616008	71	118	5	50	30	114,50
Trafic III	1.6-dCi90/115/120-TwinTurbo/140-TwinTurbo		ab e2*2007/46*0014*21, ab e2*98/14*0213*48	L/JL	09.14-	6 J x 16	205/65R16	215/65R16		16202	R1-1896	4250906818964	7503	RE616016	66	114,3	5	50	30	111,90

Modell- bezeichnung	Motorvarianten	Bemerkungen	ABE-Nummer	Fahrzeugtyp	Bauzeit von/bis	Radab- messung	Reifengröße			MWD- Nr.	MW-AM Nr.	EAN-Nr.	Alcar- Nr.	KPZ- Nr.	Bemerk.	Anschlussmaße				Stk.	Preis in €
Car model	Motorversion	General remarks	ABE-Number	Project Code	Production year	Wheel Size	Tyre Size			MWD- Ref.	MW-AM Ref.	EAN-Nr.	Alcar- Ref.	KPZ- Ref.	Remarks	Techn. Connection				Qty.	Price in €
																Center hole	Pitch circle diameter	Hole number	Offset in mm	p.Pal.	exkl. MwSt.

Saab



16045

16120

9-3/9-3X	1.8i/1.8T/1.9TiD/2.0T/2.2TiD/2.8V6-Turbo		e4*2001/116*0065*	YS3F	09.02-12.11	6½J x 16	205/55R16	215/55R16	225/55R16	16045	R1-1483	4250906814836	9455	SA516002		65	110	5	41	25	107,90
9-3 Cabrio	1.8T/1.9TiD/2.0T/2.8V6-Turbo		e4*2001/116*0077*	YS3Fx7xx/YS3FC	09.03-12.11	6½J x 16	205/55R16	215/55R16		16045	R1-1483	4250906814836	9455	SA516002		65	110	5	41	25	107,90
9-5	2.0TiD		e4*2007/46*0137*	YS3G	05.10-	6½J x 16	215/60R16	225/60R16		16120	R1-1718	4250906817189	9623	OP516012		67	120	5	41	30	102,10



Alhambra II	1.4TSI/2.0TDI/2.0TSI/4x4	e1*2007/46*0402*, e1*2007/46*0435*	7N	09.10-	6½J x 16	205/60R16	215/60R16			16117	R1-1723	4250906817233	9922	V0516028	57	112	5	33	30	105,70
Altea/Altea XL Kombi	1.2TSI/1.4/1.4TSI/1.6/1.6TDI/1.8TSI/1.9TDI/2.0TDI/2.0FSI	ab e9*2001/116*0050*23	5P	10.08-07.16	6J x 15	195/65R15				15155	R1-1489	4250906814898	9165	V0515024	57	112	5	47	40	83,80
Altea/Altea XL Kombi	1.2TSI/1.4/1.4TSI/1.6/1.6TDI/1.8TSI/1.9TDI/2.0TDI/2.0FSI/4Drive	ab e9*2001/116*0050*06	5P	10.08-07.16	6J x 16	205/55R16				16044	R1-1492	4250906814928	9535	AD516012	57	112	5	50	30	95,60
Altea/Altea XL Kombi	1.2TSI/1.4/1.4TSI/1.6/1.6TDI/1.8TSI/1.9TDI/2.0TDI/2.0FSI/4Drive	e9*2001/116*0050*	5P	06.04-07.16	6½J x 16	205/55R16				16043	R1-1491	4250906814911	9915	V0516015	57	112	5	50	30	94,80
Altea Freetrack	1.4TSI/1.6TDI	ab e9*2001/116*0050*29	5P	04.08-07.16	6J x 15	195/65R15				15155	R1-1489	4250906814898	9165	V0515024	57	112	5	47	40	83,80
Altea Freetrack/4x4	1.4TSI/1.6TDI/2.0FSI/2.0TDI/2.0TDI-CR	ab e9*2001/116*0050*22	5P	04.08-07.16	6J x 16	205/55R16	205/60R16			16044	R1-1492	4250906814928	9535	AD516012	57	112	5	50	30	95,60
Altea Freetrack/4x4	1.4TSI/1.6TDI/2.0FSI/2.0TDI/2.0TDI-CR	e9*2001/116*0050*	5P	09.07-07.16	6½J x 16	205/55R16	205/60R16			16043	R1-1491	4250906814911	9915	V0516015	57	112	5	50	30	94,80
Arona	1.0TSI/1.0TGI-Hybrid/1.5TSI/1.6TDI	e9*2007/46*3134*	KJ	12.17-	6J x 16	195/60R16	205/55R16	205/60R16		16252	R1-2034	4250906820349	6955	V0516040	57	100	5	45	30	98,80
Ateca	1.0TSI/1.4TSI/1.6TDI/2.0TSI/2.0TDI/4Drive	e9*2007/46*6394*	5FP	07.16-	6J x 16	215/60R16	225/60R16			16236	R1-1979	4250906819794	6665	V0516039	57	112	5	43	30	97,90
Exeo/ST	1.6/1.8T/2.0TDI-CR/2.0TFSI	e9*2001/116*0072*	3R	03.09-12.13	7J x 16	195/60R16	205/55R16			16133	R1-1754	4250906817547	9257	V0516029	57	112	5	45	36	107,70
Ibiza/Cordoba	1.2i-6V/1.2i-12V/1.4i-16V/1.4TDI/1.9SDI	e9*98/14*0041*, e9*2001/116*0041*	6L	05.02-05.08	5J x 14	165/70R14				14082	R1-1399	4250906813990	5210	V0514015	57	100	5	35	54	72,60
Ibiza/Cordoba	1.2i-6V/1.2i-12V/1.4i-16V/1.4TDI/1.6i-16V/1.9SDI/1.9TDI-PD	e9*98/14*0041*, e9*2001/116*0041*	6L	05.02-05.08	6J x 14	185/60R14				14083	R1-1200	4250906812009	7280	V0514016	57	100	5	43	45	82,20
Ibiza/ST	1.2-12V/1.4-16V/1.4TDI/1.6-16V/1.6TDI-CR/1.9TDI	e9*2001/116*0067*	6J	06.08-06.17	5J x 14	165/70R14	175/70R14			14082	R1-1399	4250906813990	5210	V0514015	57	100	5	35	54	72,60
Ibiza/ST	1.2-12V/1.4-16V/1.4TDI/1.4TSI/1.6-16V/1.6TDI-CR/1.9TDI/2.0TDI-CR	e9*2001/116*0067*	6J	06.08-06.17	6J x 15	175/65R15	185/60R15			15219	R1-1727	4250906817271	7760	V0515030	57	100	5	38	40	83,70
Ibiza	1.0MPI/1.0TSI	e9*2007/46*3134*	KJ	07.17-	5J x 14	185/70R14				14205	R1-2018	4250906820189	3055	V0514022	57	100	5	38	54	74,20
Ibiza	1.0MPI/1.0Eco TSI/1.0TGI/1.5TSI/1.6TDI	e9*2007/46*3134*	KJ	07.17-	5½J x 15	185/65R15				15299	R1-2019	4250906820196	4055	V0515032	57	100	5	40	48	83,30

Modell- bezeichnung	Motorvarianten	Bemerkungen	ABE-Nummer	Fahrzeugtyp	Bauzeit von/bis	Radab- messung	Reifengröße		MWD- Nr.	MW-AM Nr.	EAN-Nr.	Alcar- Nr.	KPZ- Nr.	Bemerk.	Anschlussmaße				Stk. p.Pal.	Preis in € exkl. MwSt.
Car model	Motorversion	General remarks	ABE-Number	Project Code	Production year	Wheel Size	Tyre Size		MWD- Ref.	MW-AM Ref.	EAN-Nr.	Alcar- Ref.	KPZ- Ref.	Remarks	Techn. Connection				Qty. p.Pal.	Price in € without TVA
															Center hole	Pitch circle diameter	Hole number	Offset in mm		

Seat (Fortsetzung)

Ibiza	1.0MPI/1.0Eco TSI/1.0TGI/1.5TSI/1.6TDI		e9*2007/46*3134*	KJ	07.17-	6J x 16	185/60R16	195/55R16			16252	R1-2034	4250906820349	6955	V0516040	57	100	5	45	30	98,80
Leon II	1.2TSI/1.4/1.4TSI/1.6/1.6L-PG/1.6TDI-CR/1.8TSI/1.9TDI/2.0FSI/2.0TDI		e9*2001/116*0052*	1P	10.08-11.12	6J x 15	195/65R15				15155	R1-1489	4250906814898	9165	V0515024	57	112	5	47	40	83,80
Leon II	1.2TSI/1.4/1.4TSI/1.6/1.6L-PG/1.6TDI-CR/1.8TSI/1.9TDI/2.0FSI/2.0TDI/2.0TDI-CR/2.0TFSI		e9*2001/116*0052*	1P	09.05-11.12	6J x 16	205/55R16				16044	R1-1492	4250906814928	9535	AD516012	57	112	5	50	30	95,60
Leon II	1.2TSI/1.4/1.4TSI/1.6/1.6L-PG/1.6TDI-CR/1.8TSI/1.9TDI/2.0FSI/2.0TDI/2.0TDI-CR/2.0TFSI		e9*2001/116*0052*	1P	09.05-11.12	6 1/2 J x 16	205/55R16				16043	R1-1491	4250906814911	9915	V0516015	57	112	5	50	30	94,80
Leon III	1.0TSI/1.2TSI/1.4TGI/1.4TSI/1.6TDI/2.0TDI/4-Drive		e9*2007/46*0094*	5F	12.12-03.20	6J x 15	195/65R15				15255	R1-1850	4250906818506	7755	V0515031	57	112	5	43	40	86,80
Leon III	1.2TSI/1.4TGI/1.4TSI/1.6TDI/1.8TSI/2.0TDI/4-Drive		e9*2007/46*0094*	5F	12.12-03.20	6J x 16	205/55R16				16177	R1-1851	4250906818513	8247	V0516034	57	112	5	48	30	95,10
Leon III	1.0TSI/1.2TSI/1.4TGI/1.4TSI/1.6TDI/1.8TSI/2.0TDI/4-Drive		e9*2007/46*0094*	5F	12.12-03.20	6 1/2 J x 16	205/55R16				16178	R1-1852	4250906818520	8667	V0516035	57	112	5	46	30	95,40
Leon IV/ Sportstourer	1.0TSI/2.0TDI		e9*2007/46*3167*	KL	04.20-	6J x 15	195/65R15				15310	R1-2087	4250906820875	4755	V0515033	57	112	5	43	40	84,10
Leon IV/ Sportstourer	1.0TSI/1.5TSI/1.5Hybrid/2.0TDI		e9*2007/46*3167*	KL	04.20-	6 1/2 J x 16	205/55R16				16275	R1-2088	4250906820882	6667	V0516044	57	112	5	46	30	96,10
Mii	1.0/1.0-Hybrid/electric (61kW)		e13*2007/46*1168*, e13*2007/46*1183*	AA/AAN	03.12-	5J x 14	165/70R14	175/65R14			14190	R1-1829	4250906818292	6795	V0514021	57	100	4	35	54	73,80
Tarraco	1.5TSI/2.0TDI/2.0TSI/4-Drive		e9*2007/46*6666*	KN	12.18-	6 1/2 J x 17	215/65R17				17021	R1-1981	4250906819817	9021	V0517007	57	112	5	38	25	110,90
Toledo II/Leon	1.4i/1.6i-16V/1.9SDi		e9*97/27*0026*, e9*98/14*0026*	1M	11.98-11.04	6J x 14	175/80R14				14057	R1-1273	4250906812733	7600	V0514009	57	100	5	38	45	94,80
Toledo II/Leon	1.4i-16V/1.6i-16V/1.8i-20V/1.9SDi/1.9TDI/1.9TDI-PD		e9*97/27*0026*, e9*98/14*0026*	1M	11.98-11.04	6J x 15	195/65R15				15051	R1-1229	4250906812290	8380	V0515011	57	100	5	38	40	85,90
Toledo III	1.4/1.4TSI/1.6/1.8TSI/1.9TDI/2.0TDI/2.0TSI		ab e9*2001/116*0050*23	5P	10.08-12.09	6J x 15	195/65R15				15155	R1-1489	4250906814898	9165	V0515024	57	112	5	47	40	83,80
Toledo III	1.4/1.4TSI/1.6/1.8TSI/1.9TDI/2.0TDI/2.0TSI		ab e9*2001/116*0050*06	5P	12.04-12.09	6J x 16	205/55R16				16044	R1-1492	4250906814928	9535	AD516012	57	112	5	50	30	95,60
Toledo III	1.4/1.4TSI/1.6/1.8TSI/1.9TDI/2.0TDI/2.0TSI		e9*2001/116*0050*	5P	12.04-12.09	6 1/2 J x 16	205/55R16				16043	R1-1491	4250906814911	9915	V0516015	57	112	5	50	30	94,80
Toledo IV	1.2/1.2TSI/1.4TDI		e11*2007/46*0251*, e8*2007/46*0321*	NH	12.12-	5J x 14	175/70R14				14082	R1-1399	4250906813990	5210	V0514015	57	100	5	35	54	72,60
Toledo IV	1.2/1.2TSI/1.4/1.4TSI/1.6TDI		e11*2007/46*0251*, e8*2007/46*0321*	NH	12.12-	6J x 15	185/60R15	195/55R15			15219	R1-1727	4250906817271	7760	V0515030	57	100	5	38	40	83,70



Citigo	1.0MPI/1.0-Hybrid/electric (61kW)		e13*2007/46*1169*, e13*2007/46*1184*	AA/AAN	06.12-	5J x14	165/70R14	175/65R14			14190	R1-1829	4250906818292	6795	V0514021	57	100	4	35	54	73,80
Enyaq iV	Enyaq iV50 (109kW)		e9*2007/46*0416*	NY	12.20-	8J x18	235/60R18				18005	R1-2108	4250906821087	9383		57	112	5	45	25	142,80
Enyaq iV	Enyaq iV50 (109kW) / 60 (132kW) / 80 (150kW) / 80X (220kW)	Asführung 80 nur mit VA 235/55R18 und HA 255/50R18	e8*2007/46*0416*	NY	12.20-	8J x19	235/55 VA+HA	255/50 R19HA			19004	R1-2109	4250906821094	9393		57	112	5	45	20	154,10
Fabia	1.2i/1.4i/1.4i-16V/1.4TDI/1.9SDI		e11*98/14*0123*	6Y	12.99-04.07	5J x14	165/70R14				14082	R1-1399	4250906813990	5210	V0514015	57	100	5	35	54	72,60
Fabia	1.2i/1.4i/1.4i-16V/1.4TDI/1.9SDI/1.9TDI-PD		e11*98/14*0123*	6Y	12.99-04.07	6J x14	185/60R14				14083	R1-1200	4250906812009	7280	V0514016	57	100	5	43	45	82,20
Fabia/RS	1.2i/1.4i/1.4i-16V/1.4TDI/1.9SDI/1.9TDI-PD/2.0i		e11*98/14*0123*	6Y	12.99-04.07	6J x15	185/55R15	195/50R15			15154	R1-1519	4250906815192	8000	V0515025	57	100	5	43	40	91,20
Fabia II	1.2/1.2TSI/1.4-16V/1.4TDI		bis e11*2001/116*0291*42, bis e11*2007/46*0013*19	5J	05.07-10.14	5J x14	165/70R14				14082	R1-1399	4250906813990	5210	V0514015	57	100	5	35	54	72,60
Fabia II	1.2/1.2TSI/1.4-16V/1.4TDI/1.6-16V/1.6TDI		bis e11*2001/116*0291*42, bis e11*2007/46*0013*19	5J	05.07-10.14	6J x14	185/60R14				14174	R1-1672	4250906816724	7250	V0514020	57	100	5	37	56	86,80
Fabia II/Scout	1.2/1.2TSI/1.4-16V/1.4TDI/1.6-16V/1.6TDI/1.9TDI/RS/Scout 1.2TSI/1.6TDI		bis e11*2001/116*0291*42, bis e11*2007/46*0013*19	5J	05.07-10.14	6J x15	185/55R15	185/60R15	195/55R15		15154	R1-1519	4250906815192	8000	V0515025	57	100	5	43	40	91,20
Fabia III	1.0MPI/1.2TSI/1.4TDI		ab e11*2001/116*0291*43, ab e11*2007/46*0013*20, e8*2007/46*0319*	5J	11.14-	5J x14	175/70R14				14082	R1-1399	4250906813990	5210	V0514015	57	100	5	35	54	72,60
Fabia III	1.0MPI/1.2TSI/1.4TDI/1.4TSI		ab e11*2001/116*0291*43, ab e11*2007/46*0013*20, e8*2007/46*0319*	5J	11.14-	6J x15	185/60R15	195/55R15			15219	R1-1727	4250906817271	7760	V0515030	57	100	5	38	40	83,70
Fabia IV	1.0MPI/1.0TSI		e8*2018/858*00014*	PJ	08.21-	5J x14	185/70R14				14205	R1-2018	4250906820189	3055	V0514022	57	100	5	38	54	74,20

Modell- bezeichnung	Motorvarianten	Bemerkungen	ABE-Nummer	Fahrzeugtyp	Bauzeit von/bis	Radab- messung	Reifengröße			MWD- Nr.	MW-AM Nr.	EAN-Nr.	Alcar- Nr.	KPZ- Nr.	Bemerk.	Anschlussmaße				Stk. p.Pal.	Preis in € exkl. MwSt.		
Car model	Motorversion	General remarks	ABE-Number	Project Code	Production year	Wheel Size	Tyre Size			MWD- Ref.	MW-AM Ref.	EAN-Nr.	Alcar- Ref.	KPZ- Ref.	Remarks	Techn. Connection				Qty. p.Pal.	Price in € without TVA		
																Center hole	Pitch circle diameter	Hole number	Offset in mm				

Skoda (Fortsetzung)

Fabia IV	1.0PMI/1.0TSi		e8*2018/858*00014*	PJ	08.21-	5 1/2 J x 15	185/65R15			15299	R1-2019	4250906820196	4055	V0515032		57	100	5	40	48	83,30
Kamiq	1.0-TEC/1.0TSI/1.5TSI/1.6TDI		e8*2007/46*0349*	NW	08.19-	6 J x 15	195/65R15			15304	R1-2065	4250906820653				57	100	5	35	48	83,80
Kamiq	1.0TSI/1.0TGI-Hybrid/1.5TSI/1.6TDI		e8*2007/46*0349*	NW	08.19-	6 J x 16	195/60R16	205/60R16		16277	R1-2066	4250906820660	6664	V0516041		57	100	5	35	36	99,90
Kamiq	1.0TSI/1.0TGI-Hybrid/1.5TSI/1.6TDI		e8*2007/46*0349*	NW	08.19-	6 J x 16	195/60R16	205/60R16		16280	R1-2067	4250906820677	6977	V0516042		57	100	5	40	42	94,90
Karoq	1.0TSI/1.5TSI/1.6TDI/2.0TDI/4x4		e8*2007/46*0272*	NU	11.17-	6 J x 16	215/60R16	225/60R16		16236	R1-1979	4250906819794	6665	V0516039		57	112	5	43	30	97,90
Kodiaq	1.4TSI/1.5TSI/2.0TSI/2.0TDI/4x4		e8*2007/46*0249*	NS	02.17-	6 1/2 J x 17	215/65R17			17021	R1-1981	4250906819817	9021	V0517007		57	112	5	38	25	110,90
Octavia/Tour	1.4i/1.6MPI/1.9SDI/Combi 1.6MPI/1.9SDI		e11*95/54*0066*, e11*2001/116*0066*, e11*2007/46*0011*	1U	04.97-12.10	6 J x 14	175/80R14			14057	R1-1273	4250906812733	7600	V0514009		57	100	5	38	45	94,80
Octavia/Tour	1.4i/1.6MPI/1.8i-20V/1.9SDI/1.9TDI/4x4 Combi 1.6MPI/1.8i-20V/1.9SDI/1.9TDI/4x4		e11*95/54*0066*, e11*2001/116*0066*, e11*2007/46*0011*	1U	04.97-12.10	6 J x 15	195/65R15			15051	R1-1229	4250906812290	8380	V0515011		57	100	5	38	40	85,90
Octavia II	1.2TSI/1.4-16V/1.4TSI/1.6MPI/1.6F-SI/1.6TDI/1.8TSI/1.9TDI/2.0FSI/2.0TDI/Combi 4x4 1.6TDI/1.8TSI/2.0TDI		e11*2001/116*0230*, e11*2007/46*0012*	1Z	06.04-02.13	6 J x 15	195/65R15			15155	R1-1489	4250906814898	9165	V0515024		57	112	5	47	40	83,80
Octavia II/Scout/RS	1.2TSI/1.4-16V/1.4TSI/1.6MPI/1.6F-SI/1.6TDI/1.8TSI/1.9TDI/2.0FSI/2.0TDI/Combi 4x4 1.6TDI/1.8TSI/2.0TDI/Scout 1.8TSI/2.0TDI/RS2.0TF-SI/2.0TDI		e11*2001/116*0230*, e11*2007/46*0012*	1Z	06.04-02.13	6 J x 16	205/55R16			16044	R1-1492	4250906814928	9535	AD516012		57	112	5	50	30	95,60
Octavia II	1.2TSI/1.4-16V/1.4TSI/1.6MPI/1.6F-SI/1.6TDI/1.8TSI/1.9TDI/2.0FSI/2.0TDI/Combi 4x4 1.6TDI/1.8TSI/2.0TDI		e11*2001/116*0230*, e11*2007/46*0012*	1Z	06.04-02.13	6 1/2 J x 16	205/55R16			16043	R1-1491	4250906814911	9915	V0516015		57	112	5	50	30	94,80
Octavia III	1.0TSI/1.2TSI/1.6TDI/4x4		e11*2007/46*0243*, e8*2007/46*0318*	5E	03.13-	6 J x 15	195/65R15			15255	R1-1850	4250906818506	7755	V0515031		57	112	5	43	40	86,80
Octavia III	1.0TSI/1.2TSI/1.4TSI/1.5TSI/1.6TDI/1.8TSI/2.0TDI/4x4/Scout		e11*2007/46*0243*, e8*2007/46*0318*	5E	03.13-	6 J x 16	205/55R16	205/60R16		16177	R1-1851	4250906818513	8247	V0516034		57	112	5	48	30	95,10
Octavia III	1.0TSI/1.2TSI/1.4TSI/1.5TSI/1.6TDI/1.8TSI/2.0TDI/2.0TSI/4x4		e11*2007/46*0243*, e8*2007/46*0318*	5E	03.13-	6 1/2 J x 16	205/55R16			16178	R1-1852	4250906818520	8667	V0516035		57	112	5	46	30	95,40
Octavia IV	1.0TSI/1.5TGI/1.5TSI/2.0TDI/4x4/Scout		e8*2007/46*0355*	NX	05.20-	6 1/2 J x 16	205/60R16			16275	R1-2088	4250906820882	6667	V0516044		57	112	5	46	30	96,10
Rapid/Spaceback	1.2MPI/1.2TSI/1.4TDI		e11*2007/46*0250*, e8*2007/46*0320*	NH	12.12-	5 J x 14	175/70R14			14082	R1-1399	4250906813990	5210	V0514015		57	100	5	35	54	72,60
Rapid/Spaceback	1.2MPI/1.2TSI/1.4TSI/1.6TDI		e11*2007/46*0250*, e8*2007/46*0320*	NH	12.12-	6 J x 15	185/60R15	195/55R15		15219	R1-1727	4250906817271	7760	V0515030		57	100	5	38	40	83,70
Roomster	1.2/1.2TSI/1.4-16V/1.4TDI		e11*2001/116*0291*	5J	06.06-04.15	5 J x 14	175/70R14			14082	R1-1399	4250906813990	5210	V0514015		57	100	5	35	54	72,60
Roomster	1.2/1.2TSI/1.4-16V/1.4TDI		e11*2001/116*0291*	5J	06.06-04.15	6 J x 14	185/65R14			14174	R1-1672	4250906816724	7250	V0514020		57	100	5	37	56	86,80
Roomster/Scout	1.2/1.2TSI/1.4-16V/1.4TDI/1.6-16V/1.6TDI/1.9TDI Scout 1.2TSI/1.6TDI		e11*2001/116*0291*, e11*2007/46*0013*	5J	06.06-04.15	6 J x 15	185/55R15	185/60R15	195/55R15	15154	R1-1519	4250906815192	8000	V0515025		57	100	5	43	40	91,20

Scala	1.0TSI/1.5TSI/1.6TDI		e8*2007/46*0349	NW	03.19-	6J x15	195/65R15			15304	R1-2065	4250906820653			57	100	5	35	48	83,80
Scala	1.0TSI/1.5TSI/1.6TDI		e8*2007/46*0349	NW	03.19-	6J x16	195/60R16			16277	R1-2066	4250906820660	6664	VO516041	57	100	5	35	36	99,90
Scala	1.0TSI/1.0TGI-Hybrid/1.5TSI/1.6TDI		e8*2007/46*0349	NW	03.19-	6J x16	195/60R16	205/55R16		16280	R1-2067	4250906820677	6977	VO516042	57	100	5	40	42	94,90
Superb	1.8i-Turbo/1.9TDI/2.0i/2.0TDI/2.5TDI-V6/2.8i-V6		e11*98/14*0187*	3U	01.02-08.08	6J x16	205/55R16			16005	R1-1361	4250906813617	9490	AD516004	57	112	5	40	40	118,70
Superb II/Combi	1.4TSI/1.8TSI/1.9TDI/2.0TDI/2.0TSI / Combi 1.8TSI 4x4/2.0TDI 4x4		bis e11*2001/116*0326*31, e11*2007/46*0014	3T	07.08-04.15	6J x16	205/55R16			16044	R1-1492	4250906814928	9535	AD516012	57	112	5	50	30	95,60
Superb II/Combi	1.4TSI/1.8TSI/1.9TDI/2.0TDI/2.0TSI / Combi 1.8TSI 4x4/2.0TDI 4x4		bis e11*2001/116*0326*31, e11*2007/46*0014	3T	07.08-04.15	7J x16	205/55R16			16133	R1-1754	4250906817547	9257	VO516029	57	112	5	45	36	107,70
Superb III/Combi	1.4TSI/1.6TDI/1.8TSI/2.0TDI/2.0TSI/4x4	nicht für Hybrid 115kW	ab e11*2001/116*0326*32, e8*2007/46*0317*	3T	05.15-	6½J x16	215/60R16			16219	R1-1921	4250906819213	8426	VO516037	57	112	5	41	30	99,90
Superb IV	info				11.23-	7J x16				16303	R1-2132	4250906821322		N	57	112	5	43	30	info
Yeti	1.2TSI/1.6TDI/1.8TSI/2.0TDI/4x4		e11*2007/46*0010*	5L	10.09-12.17	6J x16	205/55R16			16044	R1-1492	4250906814928	9535	AD516012	57	112	5	50	30	95,60
Yeti	1.2TSI/1.6TDI/1.8TSI/2.0TDI/4x4		e11*2007/46*0010*	5L	10.09-12.17	7J x16	205/55R16	215/60R16		16133	R1-1754	4250906817547	9257	VO516029	57	112	5	45	36	107,70

Skoda Nfz.

Fabia Praktika	1.2i/1.4i/1.4D/1.9D		L164	6Y	03.03-05.07	5J x14	165/70R14			14082	R1-1399	4250906813990	5210	VO514015	57	100	5	35	54	72,60
Fabia Praktika	1.2i/1.4TDI		L164	6Y	11.05-05.07	6J x14	185/60R14			14083	R1-1200	4250906812009	7280	VO514016	57	100	5	43	45	82,20
Fabia Praktika	1.2i/1.4TDI		L164	6Y	11.05-05.07	6J x15	185/55R15	195/50R15		15154	R1-1519	4250906815192	8000	VO515025	57	100	5	43	40	91,20
Praktik	1.2/1.2TSI/1.4-16V/1.4TDI		N083, e11*2007/46*0013*	5J	05.09-04.15	5J x14	175/70R14			14082	R1-1399	4250906813990	5210	VO514015	57	100	5	35	54	72,60
Praktik	1.2/1.2TSI/1.4-16V		ab e11*2007/46*0013*04	5J	01.10-04.15	6J x14	185/65R14			14174	R1-1672	4250906816724	7250	VO514020	57	100	5	37	56	86,80
Praktik	1.2/1.2TSI/1.4-16V/1.4TDI/1.6TDI		N083, e11*2007/46*0013*	5J	06.07-04.15	6J x15	185/55R15	185/60R15	195/55R15	15154	R1-1519	4250906815192	8000	VO515025	57	100	5	43	40	91,20

Modell- bezeichnung	Motorvarianten	Bemerkungen	ABE-Nummer	Fahrzeugtyp	Bauzeit von/bis	Radab- messung	Reifengröße	MWD- Nr.	MW-AM Nr.	EAN-Nr.	Alcar- Nr.	KPZ- Nr.	Bemerk.	Anschlussmaße				Stk. p.Pal.	Preis in € exkl. MwSt.
Car model	Motorversion	General remarks	ABE-Number	Project Code	Production year	Wheel Size	Tyre Size	MWD- Ref.	MW-AM Ref.	EAN-Nr.	Alcar- Ref.	KPZ- Ref.	Remarks	Techn. Connection				Qty. p.Pal.	Price in € without TVA
														Center hole	Pitch circle diameter	Hole number	Offset in mm		

Smart



Fortwo II	Coupé 1.0i/1.0mhd/1.0-Brabus/0.8cdi/electric (60kW) Cabrio 1.0i/1.0mhd/1.0-Brabus/0.8cdi/electric (60kW)	nur für Vorderachse	bis e1*2001/116*0413*21, e1*2007/46*0540*	451/451E	04.07-10.14	4 1/2 J x 15	155/60R15	15202	R1-1697	4250906816977	7820	MC515006		57	112	3	23,5	48	96,00
Fortwo II	Coupé 1.0i/1.0mhd/1.0-Brabus/0.8cdi/electric (60kW) Cabrio 1.0i/1.0mhd/1.0-Brabus/0.8cdi/electric (60kW)	nur für Hinterachse	bis e1*2001/116*0413*21, e1*2007/46*0540*	451/451E	04.07-10.14	5 1/2 J x 15	175/55R15	15203	R1-1698	4250906816984	7830	MC515007		57	112	3	22	48	99,20
Fortwo III (C453)	0.9/1.0/Cabrio/Brabus/EQ electric drive (60kW)	nur für Vorderachse	ab e1*2001/116*0413*22	451	11.14-	5 J x 15	165/65R15	15270	R1-1935	4250906819350	4003	MC515008		60	100	4	32	48	93,30
Fortwo III (C453)	0.9/1.0/Cabrio/Brabus/EQ electric drive (60kW)	nur für Hinterachse	ab e1*2001/116*0413*22	451	11.14-	5 1/2 J x 15	185/60R15	15271	R1-1936	4250906819367	4004	MC515009		60	100	4	42	48	94,60
Forfour	1.1i/1.3i/1.5i/1.5CDi		e1*2001/116*0263*	454	04.04-07.06	6 J x 15	195/50R15	15177	R1-1575	4250906815758	7960	MC515005		67	114,3	4	46	40	116,30
Forfour II (W453)	0.9/1.0/Brabus/electric drive (60kW)	nur für Vorderachse	ab e1*2001/116*0413*23	451	11.14-	5 J x 15	165/65R15	15270	R1-1935	4250906819350	4003	MC515008		60	100	4	32	48	93,30
Forfour II (W453)	0.9/1.0/Brabus/electric drive (60kW)	nur für Hinterachse	ab e1*2001/116*0413*23	451	11.14-	5 1/2 J x 15	185/60R15	15271	R1-1936	4250906819367	4004	MC515009		60	100	4	42	48	94,60

Streetscooter



Work	Elektro (15kW)		e1*KS07/46*0039*	B14	02.15-	6 J x 15	195/65R15	15051	R1-1229	4250906812290	8380	VO515011		57	100	5	38	40	85,90
Work	Elektro (39-51kW)		e1*KS07/46*0056*, e1*2007/46*1866*	B16/B16C	05.18-	6 J x 15	195/65R15	15051	R1-1229	4250906812290	8380	VO515011		57	100	5	38	40	85,90
Work L	Elektro (39-51kW)	nur für Vorderachse	e1*KS07/46*0070*	D16A	04.19-	6 J x 15	195/65R15	15051	R1-1229	4250906812290	8380	VO515011		57	100	5	38	40	85,90
Work L	Elektro (39-51kW)	nur für Hinterachse	e1*K07/46*0070*	D16A	04.19-	6 J x 15	195/70R15	15281	R1-1941	4250906819411	4012	FL615007		71,1	118	5	68	40	108,90
Work XL	Elektro (51-58kW)		e1*2007/46*2082*	D17	03.20-	6 1/2 J x 16	195/65R16	16163	R1-1808	4250906818087	9686	VO616024		65	120	5	52	30	129,70

Subaru



15240

16126

16269

BRZ	2.0i		e13*2007/46*1281*	ZC	03.12 -	6 1/2 JJ x 16	205/55R16			16126	R1-1725	4250906817257	9552	SB516004	56	100	5	48	30	134,90
Forester	2.0i/2.0i Turbo		e13*96/79*0029*, e1*97/27*0088*, e1*98/14*0088*	SF/SFS	05.97 - 09.02	6 1/2 JJ x 16	215/55R16	215/60R16		16126	R1-1725	4250906817257	9552	SB516004	56	100	5	48	30	134,90
Forester	2.0i/2.0i-S-Turbo/2.5i-Turbo		e13*98/14*0087*	SG	10.02 - 12.05	6 1/2 JJ x 16	215/60R16			16126	R1-1725	4250906817257	9552	SB516004	56	100	5	48	30	134,90
Forester	2.0i/2.0X/2.5XT		e1*2001/116*0209*	SG/SGS	01.06 - 03.08	6 1/2 JJ x 16	205/60R16	205/65R16	215/60R16	16126	R1-1725	4250906817257	9552	SB516004	56	100	5	48	30	134,90
Forester	2.0X/2.0D/2.5XT Turbo		e13*2001/116*0982*, e1*2001/116*0485*	SH/SHS	04.08 - 09.12	6 1/2 JJ x 16	215/65R16			16126	R1-1725	4250906817257	9552	SB516004	56	100	5	48	30	134,90
Forester	2.0X		e13*2007/46*1305*	SJ	10.12 - 12.19	6 1/2 JJ x 16	215/65R16			16126	R1-1725	4250906817257	9552	SB516004	56	100	5	48	30	134,90
Impreza	1.6i/2.0/4WD		e1*2007/46*0597*	G4	07.12 - 09.17	6 1/2 JJ x 16	205/55R16			16126	R1-1725	4250906817257	9552	SB516004	56	100	5	48	30	134,90
Impreza	1.6i/AWD		e13*2007/46*1648*	G5	10.17 -	6 1/2 J x 16	205/55R16			16269	R1-2052	4250906820523	7552		56	100	5	55	30	125,20
Legacy	2.0i/2.0D/2.5i		e1*2007/46*0079*, e13*2007/46*1074*	BM-BR/BM-BRS	09.09 - 12.15	6 1/2 JJ x 16	205/60R16	205/65R16	215/55R16	16126	R1-1725	4250906817257	9552	SB516004	56	100	5	48	30	134,90
Legacy Outback	2.5i/2.5i-GX/3.0i-H6		e1*98/14*0108*, e1*98/14*0149*	BE-BH/BE-BHS	05.99 - 08.03	6 1/2 JJ x 16	205/55R16	215/55R16	215/60R16	16126	R1-1725	4250906817257	9552	SB516004	56	100	5	48	30	134,90
Legacy Outback	2.5i/3.0i		e1*2001/116*0228*	BL-BP	09.03 - 08.09	6 1/2 JJ x 16	215/60R16			16126	R1-1725	4250906817257	9552	SB516004	56	100	5	48	30	134,90
Legacy Outback	2.0D/2.5i/3.0R		e1*2001/116*0256*	BL-BP/BL-BPS	09.03 - 08.09	6 1/2 JJ x 16	205/60R16	215/55R16	215/60R16	16126	R1-1725	4250906817257	9552	SB516004	56	100	5	48	30	134,90
Legacy Outback	2.0i/2.0D/2.5i		e13*2007/46*1074*	BM-BRS	09.09 - 12.14	6 1/2 JJ x 16	215/65R16	215/70R16	225/60R16	16126	R1-1725	4250906817257	9552	SB516004	56	100	5	48	30	134,90
Trezia	1.3i/1.4D		e11*2007/46*0021*	D1(a)	04.11 - 12.14	5 1/2 J x 15	185/65R15			15240	R1-1807	4250906818070	7210	TO515017	54	100	5	45	48	109,60

Modell- bezeichnung	Motorvarianten	Bemerkungen	ABE-Nummer	Fahrzeugtyp	Bauzeit von/bis	Radab- messung	Reifengröße		MWD- Nr.	MW-AM Nr.	EAN-Nr.	Alcar- Nr.	KPZ- Nr.	Bemerk.	Anschlussmaße				Stk. p.Pal.	Preis in € exkl. MwSt.
Car model	Motorversion	General remarks	ABE-Number	Project Code	Production year	Wheel Size	Tyre Size		MWD- Ref.	MW-AM Ref.	EAN-Nr.	Alcar- Ref.	KPZ- Ref.	Remarks	Techn. Connection				Qty. p.Pal.	Price in € without TVA
															Center hole	Pitch circle diameter	Hole number	Offset in mm		

Suzuki

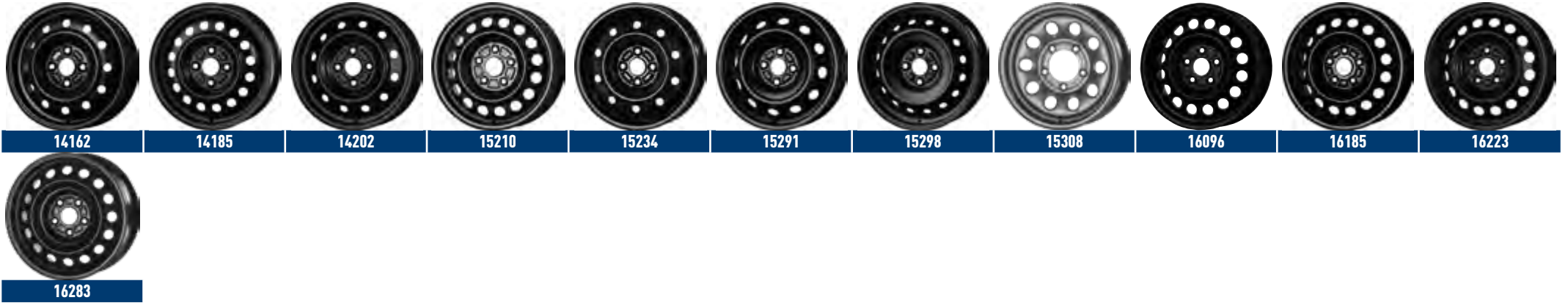

Alto	1.0		e6*2001/116*0123*	GF	04.09-12.14	4 1/2 J x 14	155/65R14			14185	R1-1763	4250906817639	5400	SU514008	54	100	4	45	56	93,20
Baleno	1.0/1.2		e6*2007/46*0177*	EW	04.16-	5 J x 15	175/65R15			15291	R1-1977	4250906819770	4045	SU515005	54	100	4	40	48	92,20
Celerio	1.0		e6*2007/46*0119*	LF	12.14-	5 J x 14	165/65R14			14202	R1-1957	4250906819572	3000	SU514010	54	100	4	45	48	96,50
Ignis III	1.2 Dualjet/1.2 Dualjet-Hybrid/4x4		e4*2007/46*1162*	MF	01.17-	5 J x 15	175/65R15			15298	R1-2013	4250906820134	4035	SU515006	54	100	4	40	48	86,80
Jimny	1.3i/1.5DDiS/4WD/Cabrio 1.3i/4WD		e6*93/B1*0056*, e9*98/14*0034*, e6*98/14*0056*, e9*2001/116*034*, e6*2001/116*0056*	FJ	05.98-12.18	5 1/2 JJ x 15	175/70R15	205//70R15		15308	R1-2074	4250906820745	4865		108,3	139,7	5	5	40	122,80
Jimny (Mj.2019)	1.5		e6*2007/46*0253*, e6*2007/46*0515*	GJ/HJ	01.19-	5 1/2 JJ x 15	195/80R15			15308	R1-2074	4250906820745	4865		108,3	139,7	5	5	40	122,80
Splash	1.0/1.2/1.3DDiS		e4*2001/116*0130*	EX	05.08-12.14	5 J x 14	165/70R14			14162	R1-1596	4250906815963	5155	SU514006	54	100	4	45	54	74,60
Splash	1.0/1.2/1.3DDiS		e4*2001/116*0130*	EX	05.08-12.14	5 1/2 J x 15	185/60R15			15216	R1-1717	4250906817172	7380	SU515003	54	100	4	50	48	100,30
Swace	1.8 Hybrid CVT		e6*2007/46*0485*	ZE1HE(S)(EU/M)	11.20-	7 J x 16	205/55R16			16283	R1-2078	4250906820783	8683		60	114,3	5	40	30	115,50
Swift	1.3i/1.3D/1.5i/4WD		e4*2001/116*0090*, -/102*	EZ/MZ	05.05-10.10	5 J x 14	165/70R14			14162	R1-1596	4250906815963	5155	SU514006	54	100	4	45	54	74,60
Swift	1.2/1.5		e4*2001116*0090*	EZ/MZ	09.05-10.10	5 1/2 J x 15	185/60R15			15192	R1-1595	4250906815956			54	100	4	45	48	89,00
Swift 1600 Sport	1.6i-16V		e4*2001/116*0090*	MZ	07.06-10.10	6 J x 15	185/60R15			15210	R1-1706	4250906817066	7150	SU515002	60	114,3	5	50	40	104,40
Swift	1.2/1.2-4x4/1.3DDiS		e4*2007/46*0155*, -/198*	NZ/FZ	11.10-04.17	5 J x 15	175/65R15			15234	R1-1780	4250906817806	6735	SU515004	54	100	4	40	48	97,90
Swift	1.20 DITC/1.2 Dualjet		e4*2007/46*1205*	AZ	05.17-	5 J x 15	175/65R15			15298	R1-2013	4250906820134	4035	SU515006	54	100	4	40	48	86,80

SX-4/SX4-Classic	Streetline/City/1.5i/1.6-VWT/1.9-DDiS/2WD	e4*2001/116*0105*, -/124*	EY/GY	05.06-12.14	6J x 15	195/65R15			15210	R1-1706	4250906817066	7150	SU515002	60	114,3	5	50	40	104,40
SX-4/SX4-Classic	Streetline/City/1.5i/1.6-VWT/1.9-DDiS/2.0-DDiS/2WD / Crossover/1.6-VWT/1.9-DDiS/2.0-DDiS/4WD	e4*2001/116*0105*, -/124*	EY/GY	05.06-12.14	6J x 16	205/60R16			16096	R1-1665	4250906816656	8315	SU516004	60	114,3	5	50	30	115,10
SX-4 S-Cross	1.6/1.6-DDiS/2WD/4WD	bis e4*2007/46*0779*03	JY	11.13-04.16	6J x 16	205/60R16			16185	R1-1878	4250906818780	8183	SU516007	60	114,3	5	50	30	112,10
SX-4 S-Cross	1.0/1.4/1.6/1.6-DDiS/2WD/4WD	ab e4*2007/46*0779*04	JY	05.16-	6 1/2 J x 16	215/60R16			16223	R1-1947	4250906819473	6525	SU516008	60	114,3	5	50	30	113,70
Vitara	1.0/1.4/1.6/1.6DDiS/4x4	e4*2007/46*0928*	LY	04.15-	6 1/2 J x 16	215/60R16			16223	R1-1947	4250906819473	6525	SU516008	60	114,3	5	50	30	113,70

Modell- bezeichnung	Motorvarianten	Bemerkungen	ABE-Nummer	Fahrzeugtyp	Bauzeit von/bis	Radab- messung	Reifengröße	MWD- Nr.	MW-AM Nr.	EAN-Nr.	Alcar- Nr.	KPZ- Nr.	Bemerk.	Anschlussmaße				Stk. p.Pal.	Preis in € exkl. MwSt.
Car model	Motorversion	General remarks	ABE-Number	Project Code	Production year	Wheel Size	Tyre Size	MWD- Ref.	MW-AM Ref.	EAN-Nr.	Alcar- Ref.	KPZ- Ref.	Remarks	Techn. Connection				Qty. p.Pal.	Price in € without TVA
													Center hole	Pitch circle diameter	Hole number	Offset in mm			

Toyota



Auris	1.33VVT-i/1.4VVT-i/1.4D-4D		e11*2001/116*0299*, bis e11*2001/116*0305*13	E15J(a)/E15UT(a)	03.07-12.12	6J x 15	195/65R15												15204	R1-1692	4250906816922	9157	T0515012	60	114,3	5	39	40	102,30
Auris II/Touring Sport	1.33VVT-i/1.4D-4D		ab e11*2001/116*0305*14	E15UT(a)	01.13-	6J x 15	195/65R15												15260	R1-1888	4250906818889	7580	T0515014	60	114,3	5	39	40	100,60
Auris II/Touring Sport	1.2-Turbo/1.33VVT-i/1.4D-4D/1.6VVT-i/2.0D-4D	Touring Sport ab e11*2001/ 116*0305*15	ab e11*2001/116*0305*14, e13*2007/46*1718*	E15UT(a)E15UT(a)-TMG	01.13-	6½J x 16	205/55R16												16184	R1-1862	4250906818629	9683	T0516012	60	114,3	5	45	30	108,40
Avensis II	2.0D-4D/2.2D-4D/2.2D-CAT		e11*2001/116*0196*	T25	07.05-12.08	6½J x 16	205/55R16												16091	R1-1668	4250906816687	8015	T0516006	60	114,3	5	45	30	118,70
Avensis III	1.6D-4D/1.6VVT-i/1.8VVT-i/2.0D-4D/2.0VVT-i		e11*2001/116*0331*	T27	01.09-12.18	6½J x 16	205/60R16												16134	R1-1744	4250906817448	7625	T0516010	60	114,3	5	39	30	123,80
Aygo	1.0VVT-i/1.4D		bis e11*2001/116*0236*10	AB1	05.05-06.14	4½J x 14	155/65R14												14163	R1-1601	4250906816014	4940	T0514017	54	100	4	39	63	83,10
Aygo II	1.0VVTi/1.2VVTi		ab e11*2001/116*0236*11, e6*2007/46*0348*, e13*2007/46*1909*	AB1/AB1-TMG	07.14-	4½J x 14	165/65R14												14198	R1-1930	4250906819305	5770	T0514021	54	100	4	35	63	80,30
Aygo II	1.0VVTi/1.2VVTi		ab e11*2001/116*0236*11, e6*2007/46*0348*, e13*2007/46*1909*	AB1/AB1-TMG	07.14-	4½J x 15	165/60R15												15275	R1-1931	4250906819312	7510	T0515019	54	100	4	35	56	95,70
Aygo X	1.0VVT-i		e13*2018/858*00229*0-0, e6*2018/858*00060*0-0	AB7(JP)	03.22-	5J x 17	175/75R17												17046	R1-2123	4250906821230	9616	N	54	100	4	40	25	131,00

Modell- bezeichnung	Motorvarianten	Bemerkungen	ABE-Nummer	Fahrzeugtyp	Bauzeit von/bis	Radab- messung	Reifengröße		MWD- Nr.	MW-AM Nr.	EAN-Nr.	Alcar- Nr.	KPZ- Nr.	Bemerk.	Anschlussmaße				Stk. p.Pal.	Preis in € exkl. MwSt.
Car model	Motorversion	General remarks	ABE-Number	Project Code	Production year	Wheel Size	Tyre Size		MWD- Ref.	MW-AM Ref.	EAN-Nr.	Alcar- Ref.	KPZ- Ref.	Remarks	Techn. Connection				Qty. p.Pal.	Price in € without TVA
															Center hole	Pitch circle diameter	Hole number	Offset in mm		

Toyota Nfz.

Hilux	2WD 2.5D-4D/4WD 2.5D-4D/4WD 3.0D-4D		e11*2007/46*0148*, -149*	N2(EU,TSAM) N2(EU,TMT)	11.10-	6J x15	205/70R15		15290	R1-1975	4250906819756				60	114,3	5	45	40	120,80
Hilux	2WD 2.5D-4D/4WD 2.5D-4D/4WD 3.0D-4D		e11*2007/46*0148*, -149*	N2(EU,TSAM) N2(EU,TMT)	11.10-	6J x16	205R16C		16234	R1-1976	4250906819763				106	139,7	6	45	30	141,10
ProAce	1.6D4-D/2.0D4-D		e2*2007/46*0388*	X	10.13-05.16	7J x16	215/60R16		16098	R1-1675	4250906816755	7780	PS616001		65	108	5	42	30	118,40
ProAce/Pro Ace Electric	1.5D-4D/1.6D-4D/2.0D-4D/Electro (100kW)		e2*2007/46*0538*	V	06.16-	7J x16	215/65R16		16237	R1-1980	4250906819800	7505	PS616003		65	108	5	46	30	105,40
ProAce	1.5D-4D/2.0D-4D/Elektro (100kW)		e2*2007/46*0538*	V	06.16-	7J x17	215/60R17		17035	R1-2046	4250906820462	9026			65	108	5	46	25	136,20
ProAce City	1.2T/1.5D		e2*2007/46*0685*	E	02.20-	6½J x15	195/65R15		15302	R1-2056	4250906820561	5477	PS615004		65	108	5	42	40	102,60
ProAce City	1.2T/1.5D		e2*2007/46*0685*	E	02.20-	6½J x16	215/65R16		16289	R1-2094	4250906820943	7461	PS616004		65	108	5	47	30	108,30

Volkswagen

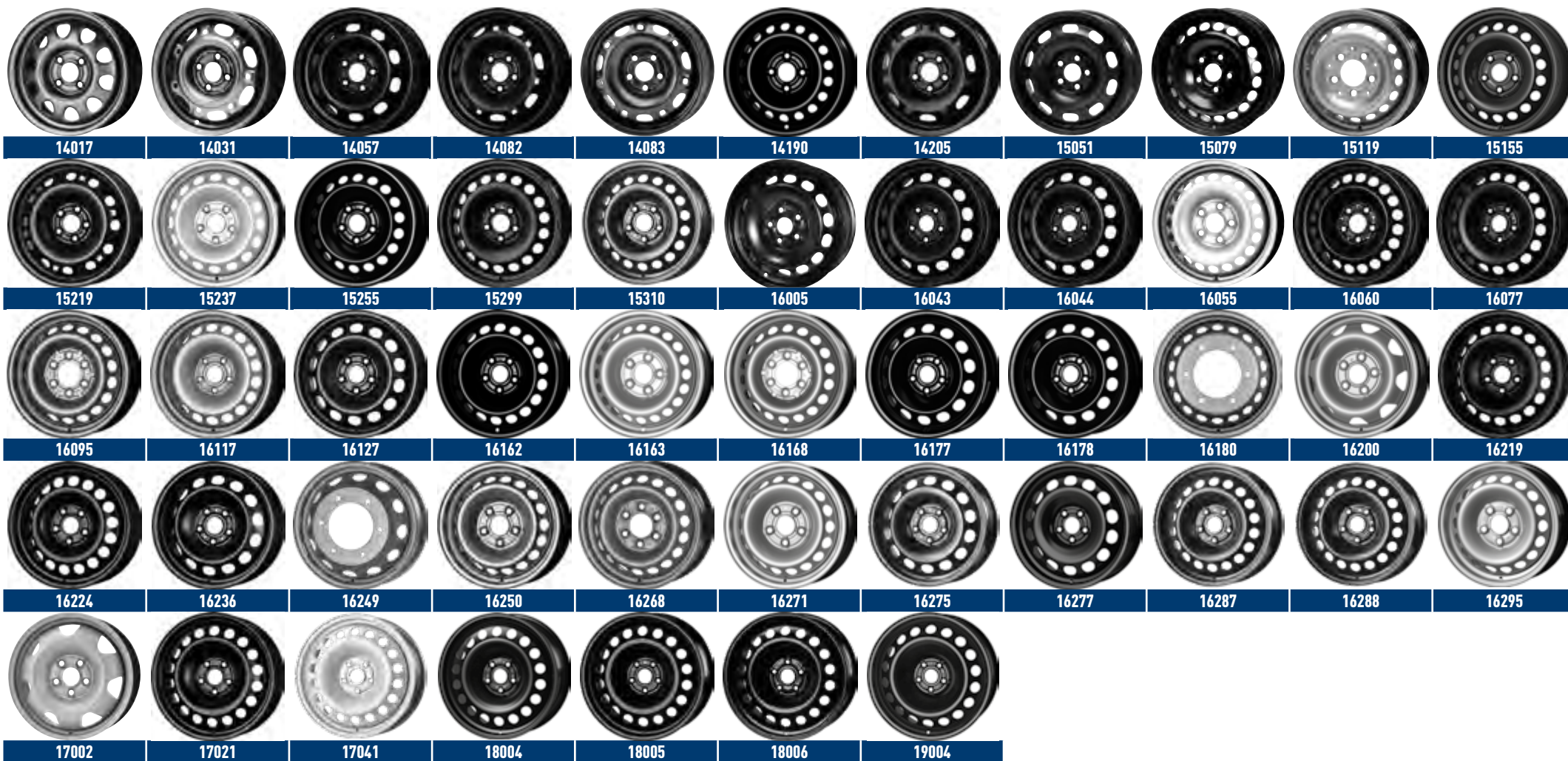

Bora/Variant	1.6i/1.6FSI/1.9TDI/1.9TDI-PD/2.0i/2.3iV5/4-motion 1.8i/1.9TDI/1.9TDI-PD/2.3iV5	e1*96/79*0071*, e1*98/14*0071*, e1*2001/116*0071*	1J	10.98-12.04	6J x 15	195/65R15				15051	R1-1229	4250906812290	8380	V0515011	57	100	5	38	40	85,90
Caddy Life	1.4i/1.6i/1.9TDI/2.0SDI/2.0TDI/2.0Ecofuel/4-motion	bis e1*2001/116*0252*41	2K	12.03-04.15	6J x 15	195/65R15				15237	R1-1796	4250906817967	8385	V0615036	57	112	5	47	40	92,80
Caddy Life/Maxi	1.4/1.6/1.9TDI/2.0TDI/2.0Ecofuel/4-motion / Maxi 1.6/1.9TDI/2.0TDI/2.0Ecofuel/4-motion	bis e1*2001/116*0252*41	2K	01.08-04.15	6J x 16	205/55R16				16127	R1-1731	4250906817318	9702	V0616021	57	112	5	50	30	102,40
Caddy Generation Four/Beach	1.2TSI/1.4TSI/1.4TGI/2.0TDI	ab e1*2001/116*0252*42	2K	05.15-10.20	6J x 15	195/65R15				15237	R1-1796	4250906817967	8385	V0615036	57	112	5	47	40	92,80
Caddy Generation Four/Beach	1.2TSI/1.4TSI/1.4TGI/2.0TDI/4-motion	ab e1*2001/116*0252*42	2K	05.15-10.20	6J x 16	205/55R16				16127	R1-1731	4250906817318	9702	V0616021	57	112	5	50	30	102,40

Legende: **N** = Neue Räder im Programm; **A** = Auslauf

Modellbezeichnung	Motorvarianten	Bemerkungen	ABE-Nummer	Fahrzeugtyp	Bauzeit von/bis	Radabmessung	Reifengröße			MWD-Nr.	MW-AM Nr.	EAN-Nr.	Alcar-Nr.	KPZ-Nr.	Bemerk.	Anschlussmaße				Stk. p.Pal.	Preis in € exkl. MwSt.		
Car model	Motorversion	General remarks	ABE-Number	Project Code	Production year	Wheel Size	Tyre Size			MWD-Ref.	MW-AM Ref.	EAN-Nr.	Alcar-Ref.	KPZ-Ref.	Remarks	Techn. Connection				Qty. p.Pal.	Price in € without TVA		
																Center hole	Pitch diameter	Hole diameter	Offset in mm				

Volkswagen (Fortsetzung)

Caddy	2.0TDI	nur kurzer Radstand mit Sensoren optional	e13*2018/858*00002*	SK	05.21 -	6J x 15	205/65R15			15237	R1-1796	4250906817967	8385	V0615036		57	112	5	47	40	92,80
Caddy	1.5TSI/2.0TDI	Radlast 650 kg	e13*2018/858*00002*, e13*2018/858*00003*	SK/SKN	11.20 -	6½J x 16	205/60R16			16288	R1-2092	4250906820929				57	112	5	48	36	106,90
Caddy	1.5TSI/2.0TDI	Radlast 720 kg	e13*2018/858*00002*, e13*2018/858*00003*	SK/SKN	11.20 -	6½J x 16	205/60R16			16287	R1-2090	4250906820905	8703			57	112	5	48	36	110,70
Caddy	1.5TSI/2.0TDI		e13*2018/858*00002*	SK	11.20 -	6½J x 17	215/55R17			17041	R1-2091	4250906820912	9703			57	112	5	49	30	116,20
Corrado	1.8i/1.8i-16V/2.0i/2.0i-16V		E664, E664/1	53I	09.91-12.95	6J x 14	185/60R14			14031	R1-878	4250906808781	7080	5953A		57	100	4	38	40	94,80
EOS	1.4TSI/1.6FSI/2.0FSI/2.0TFSI/2.0TDI/3.2V6		e1*2001/116*0349*	1F	05.06-07.16	6½J x 16	205/55R16			16077	R1-1597	4250906815970	8425	V0516025		57	112	5	42	30	100,90
Fox	1.2i/1.4i/1.4TDI		e1*2001/116*0301*	5Z	05.05-04.11	5J x 14	165/70R14	175/70R14		14082	R1-1399	4250906813990	5210	V0514015		57	100	5	35	54	72,60
Fox	1.2i/1.4i/1.4TDI		e1*2001/116*0301*	5Z	05.05-04.11	6J x 14	185/60R14			14083	R1-1200	4250906812009	7280	V0514016		57	100	5	43	45	82,20
Golf III/Vento	1.4i/1.6i/1.8i/1.9D/1.9TD/1.9SDI/2.0i		F804, e1*96/79*0068*	1HX0/1H	09.93-09.97	6J x 14	175/65R14	185/60R14	195/60R14	14017	R1-993	4250906809931	7500	V0514002		57	100	4	45	40	103,30
Golf III Syncro	1.8i/1.9TDI/2.0i		G156, e1*92/53*0004*	1HX1	09.92-09.97	6J x 14	175/65R14	185/60R14	195/60R14	14017	R1-993	4250906809931	7500	V0514002		57	100	4	45	40	103,30
Golf III Cabrio	1.6i/1.8i/1.9TDI/2.0i		G407, e1*96/79*0070*, e1*98/14*0070*	1EX0/1E	07.93-12.02	6J x 14	175/65R14	185/60R14		14017	R1-993	4250906809931	7500	V0514002		57	100	4	45	40	103,30
Golf IV	1.4i/1.6i/1.9SDI		e1*96/79*0071*, e1*98/14*0071*, e1*2001/116*0071*	1J	10.97-11.03	6J x 14	175/80R14			14057	R1-1273	4250906812733	7600	V0514009		57	100	5	38	45	94,80
Golf IV/Variant	1.4i/1.6i/1.6FSI/1.8i/1.9SDI/1.9TDI/1.9TDI-PD/2.3iV5/4-motion 1.8i/1.9TDI/1.9TDI-PD		e1*96/79*0071*, e1*98/14*0071*, e1*2001/116*0071*	1J	10.97-11.03	6J x 15	195/65R15			15051	R1-1229	4250906812290	8380	V0515011		57	100	5	38	40	85,90
Golf V	1.4i/1.6i/1.6FSI/1.8i/1.9SDI/1.9TDI/1.9TDI-PD/4-motion 1.8i/1.9TDI/1.9TDI-PD		bis e1*2001/116*0242*24	1K	12.03-09.08	6J x 15	195/65R15	205/60R15		15155	R1-1489	4250906814898	9165	V0515024		57	112	5	47	40	83,80
Golf V	1.4i/1.4FSI/1.4TSI/1.6i/1.6FSI/1.9TDI/2.0FSI/2.0SDI/2.0TDI/2.0GTI/4-motion 1.9TDI/2.0TDI/2.0FSI		bis e1*2001/116*0242*24	1K	12.03-09.08	6J x 16	205/55R16			16044	R1-1492	4250906814928	9535	AD516012		57	112	5	50	30	95,60
Golf V	1.4i/1.4FSI/1.4TSI/1.6i/1.6FSI/1.9TDI/2.0FSI/2.0SDI/2.0TDI/2.0GTI/4-motion 1.9TDI/2.0TDI/2.0FSI		bis e1*2001/116*0242*24	1K	12.03-09.08	6½J x 16	205/55R16			16043	R1-1491	4250906814911	9915	V0516015		57	112	5	50	30	94,80
Golf V Variant	1.4/1.4TSI/1.6/1.9TDI/2.0TDI		bis e1*2001/116*0328*14	1KM	05.07-08.09	6J x 15	195/65R15	205/60R15		15155	R1-1489	4250906814898	9165	V0515024		57	112	5	47	40	83,80
Golf V Variant	1.4/1.4TSI/1.6/1.9TDI/2.0TDI/2.0TSI/4-motion 1.9TDI		bis e1*2001/116*0328*14	1KM	05.07-08.09	6J x 16	205/55R16			16044	R1-1492	4250906814928	9535	AD516012		57	112	5	50	30	95,60
Golf V Variant	1.4/1.4TSI/1.6/1.9TDI/2.0TDI/2.0TSI/4-motion 1.9TDI		bis e1*2001/116*0328*14	1KM	05.07-08.09	6½J x 16	205/55R16			16043	R1-1491	4250906814911	9915	V0516015		57	112	5	50	30	94,80
Golf V Plus/Cross	1.4i/1.4TSI/1.6i/1.6FSI/1.9TDI/2.0FSI/2.0TDI/Cross 1.4TSI/1.6/1.9TDI/2.0TDI		bis e1*2001/116*0304*13	1KP	02.05-12.08	6J x 15	195/65R15	205/60R15		15155	R1-1489	4250906814898	9165	V0515024		57	112	5	47	40	83,80
Golf V Plus/Cross	1.4i/1.4TSI/1.6i/1.6FSI/1.9TDI/2.0FSI/2.0TDI/Cross 1.4TSI/1.6/1.9TDI/2.0TDI		bis e1*2001/116*0304*13	1KP	02.05-12.08	6J x 16	205/55R16			16044	R1-1492	4250906814928	9535	AD516012		57	112	5	50	30	95,60

Golf V Plus/Cross	1.4i/1.4TSI/1.6i/1.6FSI/1.9TDI/2.0FSI/2.0TDI/Cross 1.4TSI/1.6/1.9TDI/2.0TDI		bis e1*2001/116*0304*13	1KP	02.05-12.08	6½J x 16	205/55R16			16043	R1-1491	4250906814911	9915	V0516015	57	112	5	50	30	94,80
Golf VI Cabrio	1.2TSI/1.4TSI/1.6TDI/2.0TDI		e1*2001/116*0242*	1K	06.11-06.16	6J x 15	195/65R15	205/60R15		15155	R1-1489	4250906814898	9165	V0515024	57	112	5	47	40	83,80
Golf VI Cabrio	1.2TSI/1.4TSI/1.6TDI/2.0GTI/2.0TDI/2.0TSI		e1*2001/116*0242*	1K	06.11-06.16	6J x 16	205/55R16			16044	R1-1492	4250906814928	9535	AD516012	57	112	5	50	30	95,60
Golf VI Cabrio	1.2TSI/1.4TSI/1.6TDI/2.0GTI/2.0TDI/2.0TSI		e1*2001/116*0242*	1K	06.11-06.16	6½J x 16	205/55R16			16043	R1-1491	4250906814911	9915	V0516015	57	112	5	50	30	94,80
Golf VI/Plus/Cross	1.2TSI/1.4/1.4TSI/1.6/1.6BiFuel/1.6TDI/2.0TDI/Plus 1.2TSI/1.4/1.4TSI/1.6/1.6BiFuel/1.6TDI/2.0TDI	nicht 4-motion	ab e1*2001/116*0242*25, ab -/304*14, bis e1*2007/46*0490*04	1K/1KP	10.08-04.14	6J x 15	195/65R15	205/60R15		15155	R1-1489	4250906814898	9165	V0515024	57	112	5	47	40	83,80
Golf VI/Plus/Cross	1.2TSI/1.4/1.4TSI/1.6/1.6BiFuel/1.6TDI/2.0GT- D/2.0GTI/4-motion/Plus 1.2TSI/1.4/1.4TSI/1.6/1.6Bi- Fuel/1.6TDI/2.0TDI		ab e1*2001/116*0242*25, ab -/304*14, bis e1*2007/46*0490*04, -/491*	1K/1KP	10.08-04.14	6J x 16	205/55R16			16044	R1-1492	4250906814928	9535	AD516012	57	112	5	50	30	95,60
Golf VI/Plus/Cross	1.2TSI/1.4/1.4TSI/1.6/1.6BiFuel/1.6TDI/2.0GT- D/2.0GTI/4-motion/Plus 1.2TSI/1.4/1.4TSI/1.6/1.6Bi- Fuel/1.6TDI/2.0TDI		ab e1*2001/116*0242*25, ab -/304*14, bis e1*2007/46*0490*04, -/491*	1K/1KP	10.08-04.14	6½J x 16	205/55R16			16043	R1-1491	4250906814911	9915	V0516015	57	112	5	50	30	94,80
Golf VI Variant	1.2TSI/1.4/1.4TSI/1.6/1.6TDI		ab e1*2001/116*0328*15	1KM	09.09-04.14	6J x 15	195/65R15	205/60R15		15155	R1-1489	4250906814898	9165	V0515024	57	112	5	47	40	83,80
Golf VI Variant	1.2TSI/1.4/1.4TSI/1.6/1.6TDI/1.6TDI-4-motion/2.0TDI		ab e1*2001/116*0328*15, bis 1*2007/46*0492*05	1KM	09.09-04.14	6J x 16	205/55R16			16044	R1-1492	4250906814928	9535	AD516012	57	112	5	50	30	95,60
Golf VI Variant	1.2TSI/1.4/1.4TSI/1.6/1.6TDI/1.6TDI-4-motion/2.0TDI		ab e1*2001/116*0328*15, bis 1*2007/46*0492*05	1KM	09.09-04.14	6½J x 16	205/55R16			16043	R1-1491	4250906814911	9915	V0516015	57	112	5	50	30	94,80
Golf VII	1.0TSI/1.2TSI/1.4TSI/1.4TGI/1.5TSI/1.6TDI/2.0TDI//4- motion/e-Golf (85-100kW)		e1*2007/46*0623*, ab e1*2007/0490*05	AU/1K	12.12-02.20	6J x 15	195/65R15			15255	R1-1850	4250906818506	7755	V0515031	57	112	5	43	40	86,80
Golf VII	1.0TSI/1.2TSI/1.4TSI/1.4TGI/1.5TSI/1.6TDI/2.0TDI/2.0GT TI/4-motion/e-Golf (85-100kW)		e1*2007/46*0623*, ab e1*2007/0490*05	AU/1K	12.12-02.20	6J x 16	205/55R16			16177	R1-1851	4250906818513	8247	V0516034	57	112	5	48	30	95,10
Golf VII	1.0TSI/1.2TSI/1.4TSI/1.4TGI/1.5TSI/1.6TDI/2.0TDI/2.0GT TI/4-motion/e-Golf (85-100kW)		e1*2007/46*0623*, ab e1*2007/0490*05	AU/1K	12.12-02.20	6½J x 16	205/55R16			16178	R1-1852	4250906818520	8667	V0516035	57	112	5	46	30	95,40
Golf VII Variant/ Sportsvan	1.0TSI/1.2TSI/1.4TSI/1.4TGI/1.5TSI/1.6TDI/2.0TDI/4- -motion		e1*2007/46*0627*, ab e1*2007/46*0492*06	AUV/1KM	05.14-10.20	6J x 15	195/65R15			15255	R1-1850	4250906818506	7755	V0515031	57	112	5	43	40	86,80
Golf VII Variant/ Sportsvan	1.0TSI/1.2TSI/1.4TSI/1.4TGI/1.5TSI/1.6TDI/2.0TDI/4- -motion		e1*2007/46*0627*, ab e1*2007/46*0492*06	AUV/1KM	05.14-10.20	6J x 16	205/55R16			16177	R1-1851	4250906818513	8247	V0516034	57	112	5	48	30	95,10
Golf VII Variant/ Sportsvan	1.0TSI/1.2TSI/1.4TSI/1.4TGI/1.5TSI/1.6TDI/2.0TDI/4- -motion		e1*2007/46*0627*, ab e1*2007/46*0492*06	AUV/1KM	05.14-10.20	6½J x 16	205/55R16			16178	R1-1852	4250906818520	8667	V0516035	57	112	5	46	30	95,40
Golf VIII/Variant	1.0TSI/1.0-eTSI/1.5TSI/1.5-eTSI/1.5-TGI//2.0TDI		e1*2007/46*2014*, e1*2007/46*2180	CD/CDV	03.20-	6J x 15	195/65R15			15310	R1-2087	4250906820875	4755	V0515033	57	112	5	43	40	84,10
Golf VIII/Variant	1.0TSI/1.0-eTSI/1.4-eHybrid/1.5TSI/1.5-eT- SI/1.5-TGI//2.0TDI		e1*2007/46*2014*, e1*2007/46*2180	CD/CDV	03.20-	6½J x 16	205/55R16			16275	R1-2088	4250906820882	6667	V0516044	57	112	5	46	30	96,10
ID.3	ID.3 PURE (110kW)/ID.3 PRO (107/150kW)		e1*2007/46*2033*	E1	08.20-	7½J x 18	215/55R18			18004	R1-2089	4250906820899	9373		57	112	5	50	20	149,20
ID.4	ID.4 PURE (109/125kW)		e1*2018/858*00004*	E2	12.20-	8J x 18	235/60R18			18005	R1-2108	4250906821087	9383		57	112	5	45	25	142,80
ID.4	ID.4 PURE (109/125kW)/ID.4 PRO (150kW)/ID.4 PRO- GTx (220kW)		e1*2018/858*00004*	E2	12.20-	8J x 19	235/55 R19VA+HA	255/50 R19HA		19004	R1-2109	4250906821094	9393		57	112	5	45	16	154,10
ID.5	ID.5 GTX/ID.5 PRO		e1*2018/858*00004*07	E2	10.21-	8J x 19	235/55 R19VA+HA	255/50 R19HA		19004	R1-2109	4250906821094	9393		57	112	5	45	16	154,10
ID.Buzz/ID.Buzz Cargo	Pro 150(150kW)	nur Vorderachse	e1*2018/858*00164*, -/165*		03.22-	8J x 18				18005	R1-2108	4250906821087	9383		57	112	5	45	25	142,80
ID.Buzz/ID.Buzz Cargo	Pro 150(150kW)	nur Hinterachse	e1*2018/858*00164*, -/165*	EB/EBN	03.22-	8½J x 18	255/55R18			18006	R1-2131	4250906821315	9384		57	112	5	56	16	

Legende: **N** = Neue Räder im Programm; **A** = Auslauf

Modell- bezeichnung	Motorvarianten	Bemerkungen	ABE-Nummer	Fahrzeugtyp	Bauzeit von/bis	Radab- messung	Reifengröße	MWD- Nr.	MW-AM Nr.	EAN-Nr.	Alcar- Nr.	KPZ- Nr.	Bemerk.	Anschlussmaße				Stk. p.Pal.	Preis in € exkl. MwSt.
Car model	Motorversion	General remarks	ABE-Number	Project Code	Production year	Wheel Size	Tyre Size	MWD- Ref.	MW-AM Ref.	EAN-Nr.	Alcar- Ref.	KPZ- Ref.	Remarks	Techn. Connection				Qty. p.Pal.	Price in € without TVA
														Center hole	Pitch circle diameter	Hole number	Offset in mm		

Volkswagen (Fortsetzung)

Jetta	1.4TSI/1.6/1.6TDI/1.9TDI/2.0FSI/2.0TDI		e1*2001/116*0328*	1KM	09.05-12.10	6J x 15	195/65R15	205/60R15		15155	R1-1489	4250906814898	9165	V0515024	57	112	5	47	40	83,80
Jetta	1.4TSI/1.6/1.6TDI/1.9TDI/2.0FSI/2.0TDI/2.0TSI		e1*2001/116*0328*	1KM	09.05-12.10	6J x 16	205/55R16			16044	R1-1492	4250906814928	9535	AD516012	57	112	5	50	30	95,60
Jetta	1.4TSI/1.6/1.6TDI/1.9TDI/2.0FSI/2.0TDI/2.0TSI		e1*2001/116*0328*	1KM	09.05-12.10	6 1/2 J x 16	205/55R16			16043	R1-1491	4250906814911	9915	V0516015	57	112	5	50	30	94,80
Jetta	1.2TSI/1.6TDI/2.0TDI		e1*2007/46*0539*	16	01.11-12.17	6J x 15	195/65R15	205/60R15		15155	R1-1489	4250906814898	9165	V0515024	57	112	5	47	40	83,80
Jetta	1.2TSI/1.4TSI/1.6TDI/2.0TDI/2.0TSI		e1*2007/46*0539*	16	01.11-12.17	6J x 16	205/55R16			16044	R1-1492	4250906814928	9535	AD516012	57	112	5	50	30	95,60
Jetta	1.2TSI/1.6TDI/2.0TDI/2.0TSI		e1*2007/46*0539*	16	01.11-12.17	6 1/2 J x 16	205/55R16			16043	R1-1491	4250906814911	9915	V0516015	57	112	5	50	30	94,80
New Beetle/Cabrio	1.4i/1.6i/1.8T/1.9TDI/2.0i		e1*97/27*0106*, e1*98/14*0106*, e1*2001/116*0106*, -/205*	9C/1Y	10.98-07.12	6J x 15	195/65R15			15051	R1-1229	4250906812290	8380	V0515011	57	100	5	38	40	85,90
Beetle/Cabrio	1.2TSI/1.4TSI/1.6TDI/2.0TDI/2.0TSI		e1*2007*46*0539*	16	10.11-	6 1/2 J x 16	205/60R16	215/60R16		16162	R1-1810	4250906818100	9173	V0516033	57	112	5	44	30	110,80
Passat/Variant	1.6i/1.6TD/1.8i/1.9D/1.9D/2.0i/2.0i-16V/Syncro 2.0i		E657, E657/1, E960	35I/35I-299	04.88-12.96	6J x 14	165/70R14	185/65R14	195/60R14	14031	R1-878	4250906808781	7080	5953A	57	100	4	38	40	94,80
Passat/Variant	1.6i/1.8iV/1.9TDI/2.3iVR5/2.5iV6TDI/2.8iV6/4-motion 1.8iV/1.9TDI/2.3iVR5/2.5iV6TDI/2.8iV6		e1*95/54*0043*, e1*98/14D0043*, e1*98/14*0043*	3B	10.96-10.00	6J x 15	195/65R15			15079	R1-1014	4250906810142	8860	AD515008	57	112	5	45	40	97,20
Passat/Variant	1.6i/1.8iV5-Turbo/1.9TDI/1.9TDI-PD/2.0i/4-motion 1.9TDI/1.9TDI-PD/2.0i		e1*98/14*0157*, e1*2001/116*0157*	3B6	11.00-02.05	6J x 15	195/65R15			15079	R1-1014	4250906810142	8860	AD515008	57	112	5	45	40	97,20
Passat/Variant	1.6i/1.8iV5-Turbo/1.9TDI/1.9TDI-PD/2.0i/2.3iV5/2.5iV6-TDI/4-motion 1.9TDI/1.9TDI-PD/2.3iV5/2.5iV6-TDI/2.8		e1*98/14*0157*, e1*2001/116*0157*	3B6	11.00-02.05	6J x 16	205/55R16			16005	R1-1361	4250906813617	9490	AD516004	57	112	5	40	40	118,70
Passat/Variant	1.4TSI/1.6i/1.6FSI/1.6TSI/1.6TDI/1.8TSI/1.9TDI/2.0TDI/2.0BlueTDI/2.0FSI/2.0TSI/4-motion		bis e1*2001/116*0307*23	3C	03.05-09.10	6 1/2 J x 16	205/55R16	215/55R16		16077	R1-1597	4250906815970	8425	V0516025	57	112	5	42	30	100,90
Passat/Variant	1.4TSI/1.6TDI/1.8TSI/1.8TSI/2.0TDI/4-motion		ab e1*2001/116*0307*24 bis *36, e1*2007/46*0502*, -/547*, DE2007/46*0547*	3C/3c	10.10-09.14	6 1/2 J x 16	205/55R16	215/55R16		16077	R1-1597	4250906815970	8425	V0516025	57	112	5	42	30	100,90
Passat/Variant (Mj. 2015)	1.4TSI/1.6TDI/1.8TSI/2.0TDI/4-motion	nicht Passat Hybrid	ab e1*2001/116*0307*37	3C	10.14-	6 1/2 J x 16	215/60R16			16219	R1-1921	4250906819213	8426	V0516037	57	112	5	41	30	99,90
Polo III	1.0i 45/1.4i 60/1.4TDI/1.6i 75/1.7SDI 60S/1.9D 64/1.6GTi 100		e1*96/79*0069*	6N	10.94-11.01	6J x 14	185/55R14			14017	R1-993	4250906809931	7500	V0514002	57	100	4	45	40	103,30
Polo IV	1.2i/1.4i/1.4FSI/1.4TDI-PD/1.9SDI/1.4TDI BlueMotion		e1*98/14*0174*, e1*2001/116*0174*	9N	12.01-04.09	5J x 14	165/70R14			14082	R1-1399	4250906813990	5210	V0514015	57	100	5	35	54	72,60
Polo IV	1.2i/1.4i/1.4i-16V/1.4FSI/1.4TDI-PD/1.6i-16V/1.9SDI/1.9TDI-PD		e1*98/14*0174*, e1*2001/116*0174*	9N	12.01-04.09	6J x 14	185/60R14			14083	R1-1200	4250906812009	7280	V0514016	57	100	5	43	45	82,20
Polo IV Fun/Cross	1.2i/1.4i/1.4FSI/1.4i-16V/1.4TDI/1.6i-16V/1.9TDI	höher gelegtes Fahrwerk	e1*2001/116*0174*	9N	01.04-04.09	6J x 15	185/60R15			15051	R1-1229	4250906812290	8380	V0515011	57	100	5	38	40	85,90
Polo V	1.0TSI/1.2/1.2TDI/1.2TSI/1.4/1.4Bi-Fuel/1.4TDI/1.6TDI(66kW)		e1*2001/116*0510*, e1*2007/46*0486*	6R	05.09-08.17	5J x 14	175/70R14			14082	R1-1399	4250906813990	5210	V0514015	57	100	5	35	54	72,60
Polo V	1.0TSI/1.2/1.2TDI/1.2TSI/1.4/1.4BiFuel/1.4GTI/1.6TDI/Cross		e1*2001/116*0510*, e1*2007/46*0486*	6R	05.09-08.17	6J x 15	175/65R15	185/60R15		15219	R1-1727	4250906817271	7760	V0515030	57	100	5	38	40	83,70

Polo VI	1.0/1.0TGI/1.0TSI		e1*2007/46*1783*	AW	09.17-	5 J x 14	185/70R14				14205	R1-2018	4250906820189	3055	V0514022	57	100	5	38	54	74,20
Polo VI	1.0/1.0TSI/1.5TSI/1.6TDI		e1*2007/46*1783*	AW	09.17-	5 1/2 J x 15	185/65R15				15299	R1-2019	4250906820196	4055	V0515032	57	100	5	40	48	83,30
Scirocco III	1.4TSI/1.8TSI/2.0TSI/2.0TDI		e1*2001/116*0471*	13	08.08-12.17	6 1/2 J x 16	205/55R16				16077	R1-1597	4250906815970	8425	V0516025	57	112	5	42	30	100,90
Sharan II	1.4TSI/2.0TDI/4-motion		e1*2007/46*0401*, -/434*	7N	07.10-	6 1/2 J x 16	205/60R16	215/60R16			16117	R1-1723	4250906817233	9922	V0516028	57	112	5	33	30	105,70
Taigo	1.0TSI/1.5TSI		e13*2018/858*00140*	CS	11.21-	6 J x 16	195/60R16	205/60R16			16277	R1-2066	4250906820660	6664	V0516041	57	100	5	35	36	99,90
T-Cross	1.0TSI/1.5TSI/1.6TDI		e13*2007/46*1985*	C1	03.19-	6 J x 16	195/60R16	205/60R16			16277	R1-2066	4250906820660	6664	V0516041	57	100	5	35	36	99,90
T-Roc/Cabrio	1.0TSI/1.5TSI/2.0TSI/2.0TDI/4-motion / Cabrio 1.0TSI/1.5TSI		e13*2007/46*1845*	A1	11.17-	6 J x 16	205/60R16	215/60R16			16236	R1-1979	4250906819794	6665	V0516039	57	112	5	43	30	97,90
Tiguan	1.4TSI/2.0TDI/2.0-TFSI/4-motion		bis e1*2001/116*0450*23, bis e1*2007/46*0487*14	5N	12.07-04.16	6 1/2 J x 16	215/65R16				16117	R1-1723	4250906817233	9922	V0516028	57	112	5	33	30	105,70
Tiguan II/Tiguan Allspace	1.4TSI/1.6TDI/2.0TDI/2.0TSI/4-motion		ab e1*2001/116*0450*24, ab e1*2007/46*0487*15	5N	05.16-	6 1/2 J x 17	215/65R17				17021	R1-1981	4250906819817	9021	V0517007	57	112	5	38	25	110,90
Touareg	VR5-TDI		e1*2001/116*0203*	7L	01.03-03.10	7 J x 16	235/70R16				16060	R1-1482	4250906814829	9365	V0516016	65,1	120	5	54	30	173,10
Touran/Cross	1.4TSI/1.6/1.6TDI/1.9TDI/2.0FSI/2.0TDI/2.0-Ecofuel/ Cross 1.4TSI/1.6/1.9TDI/2.0TDI		bis e1*2001/116*0211*35, bis e1*2007/46*0357*13, DE*2007/46*0506*, e1*2007/46*0506*	1T/1t	03.03-08.15	6 J x 15	195/65R15				15155	R1-1489	4250906814898	9165	V0515024	57	112	5	47	40	83,80
Touran/Cross	1.4TSI/1.6/1.6TDI/1.9TDI/2.0FSI/2.0TDI/2.0-Ecofuel/ Cross 1.4TSI/1.6/1.9TDI/2.0TDI		bis e1*2001/116*0211*35, bis e1*2007/46*0357*13, DE*2007/46*0506*	1T/1t	03.03-08.15	6 J x 16	205/55R16				16044	R1-1492	4250906814928	9535	AD516012	57	112	5	50	30	95,60
Touran	1.2TSI/1.4TSI/1.6/1.6FSI/1.6TDI/1.9TDI/2.0F- SI/2.0TDI/2.0-Ecofuel		bis e1*2001/116*0211*35, bis e1*2007/46*0357*13, -/506*, DE*2007/46*0506*	1T/1t	03.03-08.15	6 1/2 J x 16	205/55R16				16043	R1-1491	4250906814911	9915	V0516015	57	112	5	50	30	94,80
Touran II	1.2TSI/1.4TSI/1.6TDI/1.8TSI/2.0TDI		ab e1*2001/116*0211*36, ab e1*2007/46*0357*14	1T	09.15-	6 1/2 J x 16	205/60R16				16224	R1-1958	4250906819589	7025	V0516038	57	112	5	48	30	106,90
T5 Multivan/ California/ Caravelle	1.9TDI/2.0i/2.5TDI/4-motion		e1*2001/116*0218*, -/286*, bis -/220*35, bis -/289*24	7HM/7HMA/7HC/7HCA	05.03-07.15	6 1/2 J x 16	205/65C16	215/65C16			16055	R1-1529	4250906815291	9685	V0616016	65,1	120	5	51	30	110,90
T5 Multivan/ California/ Caravelle	1.9TDI/2.0i/2.5TDI/4-motion		e1*2001/116*0286*, bis -/220*35	7HC/7HCA	05.03-07.15	6 1/2 J x 16	205/65C16	215/65C16			16163	R1-1808	4250906818087	9686	V0616024	65	120	5	52	30	129,70
T5 Multivan/ California/ Caravelle	1.9TDI/2.0i/2.0TDI/2.5TDI/3.2i-V6/4-motion		e1*2001/116*0218*, -/286*, bis -/220*35, bis -/289*24	7HM/7HMA/7HC/7HCA	05.03-07.15	7 J x 17	215/65C17	235/55R17			17002	R1-1614	4250906816144	9215	V0617001	65,1	120	5	55	25	169,70
T6 Multivan/ California/ Caravelle	2.0TDI/2.0TDI-BMT/4-motion, ABT e-Caravelle (83kW)		ab e1*2001/116*0220*36, ab e1*2001/116*0289*25, ab e1*2007/46*0130*16, e24*KS07/46*0675*	7HC/7HMA/7JO/EDPM	08.15-	6 1/2 J x 16	205/65C16	215/65C16			16055	R1-1529	4250906815291	9685	V0616016	65,1	120	5	51	30	110,90
T6 Multivan/ California/ Caravelle	2.0TDI/2.0TDI-BMT/4-motion, ABT e-Caravelle (83kW)		ab e1*2001/116*0220*36, ab e1*2007/46*0130*16, e24*KS07/46*0613*, -/0675*	7HC/7JO/EDTM/EDPM	08.15-	6 1/2 J x 16	205/65C16	215/65C16			16163	R1-1808	4250906818087	9686	V0616024	65	120	5	52	30	129,70
T6 Multivan/ California/ Caravelle	2.0TDI/2.0TDI-BMT/4-motion, ABT e-Caravelle (83kW)		ab e1*2001/116*0220*36, ab e1*2001/116*0289*25, ab e1*2007/46*0130*16, e24*KS07/46*0675*	7HC/7HMA/7JO/EDPM	08.15-	7 J x 17	215/60R17	235/55R17			17002	R1-1614	4250906816144	9215	V0617001	65,1	120	5	55	25	169,70
T7	1.4TSI/1.5TSI		e1*2018/858*00018*	ST	12.21-	6 1/2 J x 16	195/75R16	215/65R16			16295	R1-2114	4250906821148	6694		65	120	5	60	30	123,90
UP/e-UP/Cross-UP	1.0TSI/Ecofuel/electric/e-load up (60/61kW)		e13*2007/46*1167*, e13*2007/46*1182*	AA/AAN	12.11-	5 J x 14	165/70R14	175/65R14			14190	R1-1829	4250906818292	6795	V0514021	57	100	4	35	54	73,80

Legende: **N** = Neue Räder im Programm; **A** = Auslauf

Modell- bezeichnung	Motorvarianten	Bemerkungen	ABE-Nummer	Fahrzeugtyp	Bauzeit von/bis	Radab- messung	Reifengröße			MWD- Nr.	MW-AM Nr.	EAN-Nr.	Alcar- Nr.	KPZ- Nr.	Bemerk.	Anschlussmaße				Stk. p.Pal.	Preis in € exkl. MwSt.
Car model	Motorversion	General remarks	ABE-Number	Project Code	Production year	Wheel Size	Tyre Size			MWD- Ref.	MW-AM Ref.	EAN-Nr.	Alcar- Ref.	KPZ- Ref.	Remarks	Techn. Connection				Qty. p.Pal.	Price in € without TVA
																Center hole	Pitch circle diameter	Hole number	Offset in mm		

Volkswagen Nfz.

Amarok	2.0TDI/2.0TDI-BMT/2.0BiTDI/2.0BiTDI-BMT/2x4/4x4		e1*2007/46*0356*,-/750*	2H/2HS2	10.10-	6 1/2 J x 16	205R16C			16163	R1-1808	4250906818087	9686	VO616024		65	120	5	52	30	129,70
Caddy/Kombi	1.4/1.6/1.9TDI/2.0SDI/2.0Ecofuel/4-motion		L320, bis e1*2007/46*0217*19	2KN	12.03-04.15	6 J x 15	195/65R15			15237	R1-1796	4250906817967	8385	VO615036		57	112	5	47	40	92,80
Caddy/Maxi/Kombi	1.4/1.6/1.9TDI/2.0SDI/2.0TDI/2.0Ecofuel/4-motion		L320, bis e1*2007/46*0217*19	2KN	01.08-04.15	6 J x 16	205/55R16			16127	R1-1731	4250906817318	9702	VO616021		57	112	5	50	30	102,40
Caddy/Maxi	1.2TSI/1.4TSI/1.4TGI/2.0TDI		ab e1*2007/46*0017*20	2KN	05.15-10.20	6 J x 15	195/65R15			15237	R1-1796	4250906817967	8385	VO615036		57	112	5	47	40	92,80
Caddy/Maxi	1.2TSI/1.4TSI/1.4TGI/2.0TDI/4-motion/ABT e-Caddy (83kW)		ab e1*2007/46*0017*20, e24*KS07*46*0652*	2KN/EDCM	05.15-10.20	6 J x 16	205/55R16			16127	R1-1731	4250906817318	9702	VO616021		57	112	5	50	30	102,40
Caddy Cargo	2.0TDI	nur für kurzen Radstand	e13*2018/858*00003*	SKN	05.21-	6 J x 15	205/65R15			15237	R1-1796	4250906817967	8385	VO615036		57	112	5	47	40	92,80
Caddy Cargo	1.5TSI/2.0TDI	Radlast 650 kg	e13*2018/858*00003*	SKN	11.20-	6 1/2 J x 16	205/60R16			16288	R1-2092	4250906820929				57	112	5	48	36	106,90
Caddy Cargo	1.5TSI/2.0TDI	Radlast 720 kg	e13*2018/858*00003*	SKN	11.20-	6 1/2 J x 16	205/60R16			16287	R1-2090	4250906820905	8703			57	112	5	48	36	110,70
Caddy Cargo	1.5TSI/2.0TDI		e13*2018/858*00003*	SKN	11.20-	6 1/2 J x 17	215/55R17			17041	R1-2091	4250906820912	9703			57	112	5	49	30	116,20
Crafter 30	2EC1/2FJE1/2EKE1/2EKE2		e1*2001/116*0355*, e1*2007/46*0513*, -/514*, -/515*, -/521*, L767, L769, L770	2EC1/2FJE1/2EKE1/2EKE2	05.06-02.17	6 1/2 J x 16	205/75R16	225/75R16	235/65R16	16268	R1-2050	4250906820509	7488	ME616013		84	130	6	62	36	118,50
Crafter 30/35	2.5TDI	zulässig bis 3.5t Gesamtgewicht	e1*2001/116*0355*, -/356*, e1*2007/46*0514*, -/515*, -/521*, -/522*, -/523*, L767, L768, L769, L770	2EC1/2EC2/2EKE1/2EKE2/2FJE1/2FJE2	05.06-02.17	6 1/2 J x 16	225/75R16	235/65R16		16268	R1-2050	4250906820509	7488	ME616013		84	130	6	62	36	118,50
Crafter 30	2.5TDI	zulässig bis 3.0t Gesamtgewicht	e1*2001/116*0355*, e1*2007/46*0513*, -/514*, -/515*, -/521*, L767, L769, L770	2EC1/2FJE1/2EKE1/2EKE2	05.06-02.17	6 1/2 J x 16	205/75R16	225/75R16	235/65R16	16095	R1-1647	4250906816472	9488	ME616013		84	130	6	62	30	122,10
Crafter 30	2.0TDI/2.5TDI	zulässig bis 3.0t Gesamtgewicht	L767, L768, e1*2001/116*0355*, e1*2007/46*0513*, e1*2007/46*0521*	2EC1, 2EKE1, 2EKE2, 2FJE1, 2FJE2	06.06-02.17	5 1/2 J x 16	205/75R16			16168	R1-1673	4250906816731		ME616037		84	130	6	51	30	119,20
Crafter 30/35	2.5TDI	zulässig bis 3.5t Gesamtgewicht	e1*2001/116*0355*, -/356*, e1*2007/46*0514*, -/515*, -/521*, -/522*, -/523*, L767, L768, L769, L770	2EC1/2EC2/2EKE1/2EKE2/2FJE1/2FJE2	05.06-02.17	6 1/2 J x 16	225/75R16	235/65R16		16095	R1-1647	4250906816472	9488	ME616013		84	130	6	62	30	122,10
Crafter 35/50	2.5TDI - Zwillingbereifung	zulässig bis 5.0t Gesamtgewicht	ab e1*2007/46*0518*06, ab -/519*08, ab -/524*06, ab -/525*05	2FJZ/2EKZ	05.06-02.17	5 1/2 J x 16	195/75R16	205/75R16		16180	R1-1859	4250906818599	7870	ME616036		161	205	6	HMA 117	30	175,00
Crafter II 30/35/E-Crafter	2.0TDI-BMT/4-motion/E-Crafter (100kW/130kW)		e1*2007/46*1613*, e1*2007/46*1619*, -/1935*	SYN1E/SZN1E/SYMWE	03.17-	6 1/2 J x 16	205/75R16	235/65R16		16250	R1-2016	4250906820165	6695	VO616031		65,1	120	5	60	30	120,30
Crafter II 35/E-Crafter	2.0TDI-BMT/4-motion/E-Crafter (100kW/130kW)	Radlast 1200 kg	e1*2007/46*1613*, -/1614*, -/1619*, -/1620*, -/1953*	SYN1E/SYN2E/SZN1E/SZN2E/SYMVE	03.17-	6 1/2 J x 16	235/65R16			16271	R1-2053	4250906820530	6696	VO616029		65,1	120	5	60	30	135,90
Crafter II 35/50	2.0TDI-BMT/4-motion		e1*2007/46*1615*, -/1616*, -/1621*, -/1622*	SYN1Z/SYN2Z/SZN1Z/SZN2Z	03.17-	5 1/2 J x 16	205/75R16			16249	R1-2015	4250906820158	6685	VO616030		161	205	6	HMA 121,5	30	190,10
LT28/35	2.3i/2.5SDI/2.5TDI/2.8TDI		H428, H482, e1*95/54*0041*, e1*98/14*0041*, e1*98/14D0041*, e1*2001/116*0041*	2DM/2DX0AE/2DX0FE	01.00-04.06	6 J x 15	195/70R15	225/70R15		15119	R1-1404	4250906814041	8555	ME615016		84	130	5	75	40	124,10
T5 Transporter	1.9TDI/2.0i/2.0TDI/2.5TDI/4-motion		L148, L225, bis e1*2007/46*0130*15	7HK/7HKK0/7J0	05.03-07.15	6 1/2 J x 16	205/65C16	215/65C16		16055	R1-1529	4250906815291	9685	VO616016		65,1	120	5	51	30	110,90

T5 Transporter	1.9TDI/2.0i/2.0TDI/2.5TDI/4-motion	L148, L225, bis e1*2007/46*0130*15	7HK/7JO	05.03-07.15	6½J x 16	205/65C16	215/65C16		16163	R1-1808	4250906818087	9686	VO616024	65	120	5	52	30	129,70
T5 Transporter	1.9TDI/2.0i/2.0TDI/2.5TDI/3.2i-V6/4-motion	L148, L225, bis e1*2007/46*0130*15	7HC/7HXXO/7JO	05.03-07.15	7J x 17	215/60R17	235/55R17		17002	R1-1614	4250906816144	9215	VO617001	65,1	120	5	55	25	169,70
T5 BlueMotion	2.0TDI	e1*2001/116*0218*,-0220*	7HC/7HMA/7JO	03.11-	6½J x 16	205/65R16	215/65R16		16200	R1-1809	4250906818094		VO616025	65	120	5	51	30	106,20
T6/T6.1 Transporter	2.0TDI/2.0TDI-BMT/4-motion	ab e1*2007/46*0130*16, e24*KS07/46*0619,-/668*, e24*2018/00022*	7JO/EDTN/EDPN/ABT-EDPN	08.15-	6½J x 16	205/65C16	215/65C16		16055	R1-1529	4250906815291	9685	VO616016	65,1	120	5	51	30	110,90
T6/T6.1 Transporter	2.0TDI/2.0TDI-BMT/4-motion / ABT e-Transporter (83kW)	ab e1*2007/46*0130*16, e24*KS07/46*0619,-/668*, e24*2018/858*00022*,-/37*	7JO/EDTN/EDPN/ABT-EDPN/ABT-EDPP	08.15-	6½J x 16	205/65C16	215/65C16		16163	R1-1808	4250906818087	9686	VO616024	65	120	5	52	30	129,70
T6/T6.1 Transporter	2.0TDI/2.0TDI-BMT/4-motion / ABT e-Transporter (83kW)	ab e1*2007/46*0130*16, e24*KS07/46*0619,-/668*, e24*2018/858*00022*	7JO/EDTN/EDPN/ABT-EDPN	08.15-	7J x 17	215/60R17	235/55R17		17002	R1-1614	4250906816144	9215	VO617001	65,1	120	5	55	25	169,70
T7			ST	05.22-	6½J x 16	195/75R16	215/65R16		16295	R1-2114	4250906821148	6694		65	120	5	60	30	123,90

Volvo



16070

16088

C30	1.6i/1.6D/1.8i/1.8F/2.0i/2.0D/2.4i/2.4D5/2.5T5	e4*2001/116*0076*, e1*2001/116*0427*	M/M-2D	10.06-12.12	6½J x 16	195/60R16	205/55R16		16070	R1-1577	4250906815772	9225	VV516004	63,3	108	5	52,5	30	115,90
S40/V50	1.6/1.6D/1.8/1.8F/2.0/2.0D/2.4/2.4i/2.4D5/2.5T5/2.5T5-AWD	e4*2001/116*0076*	M	01.04-08.12	6½J x 16	195/60R16	205/55R16		16070	R1-1577	4250906815772	9225	VV516004	63,3	108	5	52,5	30	115,90
S60/V60	1.6T3/1.6T4/2.0T/2.0T5/3.0T6/2.0D3/2.4D5/2.4D5-AWD	e9*2007/46*0023*	F	07.10-12.18	7J x 16	205/60R16	215/55R16		16088	R1-1642	4250906816427	8275	VV516005	63,3	108	5	50	40	127,60
S60/V60 Cross Country	2.0/2.0D/2.0D-AWD/2.4D-AWD/2.5AWD	e9*2001/46*0023*	F	09.15-12.18	7J x 16	215/65R16			16088	R1-1642	4250906816427	8275	VV516005	63,3	108	5	50	40	127,60
S80	1.6D/2.0D/2.0F/2.0FT/2.4D/2.4D5/2.4D5-AWD/2.5T/3.0T6/3.2/3.2-AWD	e9*2001/116*0057*	A	05.06-12.16	7J x 16	205/60R16	215/55R16	225/55R16	16088	R1-1642	4250906816427	8275	VV516005	63,3	108	5	50	40	127,60
V40	1.6D-D2/2.0D-D3/D4/1.6-T2/T3/T4/2.5-T5	e1*2001/116*0076*	M	07.12-10.19	6½J x 16	205/55R16			16070	R1-1577	4250906815772	9225	VV516004	63,3	108	5	52,5	30	115,90
V40 Cross Country	1.6D-D2/2.0D-D3/D4/1.6-T4/2.5-T5/AWD	ab e1*2001/116*0076*29	M	10.12-	6½J x 16	205/60R16			16070	R1-1577	4250906815772	9225	VV516004	63,3	108	5	52,5	30	115,90
V70	1.6D/2.0/2.0D/2.0F/2.4D/2.4D5/2.5FT/2.5T/3.2/3.0T6-AWD	e9*2001/116*0065*, e1*2001/116*0505*	B/B-2D	05.07-05.16	7J x 16	205/60R16	225/55R16		16088	R1-1642	4250906816427	8275	VV516005	63,3	108	5	50	40	127,60
XC70	2.4D5/3.0AWD/3.2AWD	e9*2001/116*0065* e1*2001/116*0505*	B/B-2D	05.07-05.16	7J x 16	215/65R16			16088	R1-1642	4250906816427	8275	VV516005	63,3	108	5	50	40	127,60

Legende: **N** = Neue Räder im Programm; **A** = Auslauf

MWD-Nr.	MW-AM Nr.	Fahrzeughersteller	Modellbezeichnung	Radabmessung	Gewicht pro Rad	Stk. pro PaL.	Preis in € ohne MwSt.
MWD-Ref.	MW-AM Ref.	Car producer	Car model	Wheel size	Weight p. wheel	Qty. p. PaL.	Price in € without TVA

MWD-Nr.	MW-AM Nr.	Fahrzeughersteller	Modellbezeichnung	Radabmessung	Gewicht pro Rad	Stk. pro PaL.	Preis in € ohne MwSt.
MWD-Ref.	MW-AM Ref.	Car producer	Car model	Wheel size	Weight p. wheel	Qty. p. PaL.	Price in € without TVA

MWD-Nr.	MW-AM Nr.	Fahrzeughersteller	Modellbezeichnung	Radabmessung	Gewicht pro Rad	Stk. pro PaL.	Preis in € ohne MwSt.
MWD-Ref.	MW-AM Ref.	Car producer	Car model	Wheel size	Weight p. wheel	Qty. p. PaL.	Price in € without TVA

Radnummern aufsteigend

12013	R1-1749	Piaggio	Ape	4,00 Bx12		72	
13032	R1-964	Opel	Corsa-B	5 Jx13	6,50	54	63,40
13032	R1-964	Opel Nfz.	Corsa-B-Van	5 Jx13	6,50	54	63,40
13041	R1-950	Renault	Clio I	4,50 Bx13	5,10	63	78,60
			Twingo I	4,50 Bx13	5,10	63	
13068	R1-1303	Renault Nfz.	Kangoo Rapid	5,00 Bx13	6,40	54	69,80
13072	R1-1280	Fiat	Seicento	5,00 Bx13	5,00	54	89,90
13083	R1-1300	Citroën	ZX/ZX Break	5,00 Bx13	5,60	63	74,80
			205	5,00 Bx13	5,60	63	
			206	5,00 Bx13	5,60	63	
13099	R1-1004	Fiat	Cinquecento	4,50 Bx13	4,95	63	78,90
13115	R1-1471	Fiat	Panda/Classic	5,00 Bx13	4,90	54	75,60
13116	R1-1572	Hyundai	i10	4,00 Bx13	5,25	72	91,20
		Kia	Picanto	4,00 Bx13	5,25	72	
			Picanto II	4,00 Bx13	5,25	72	
13119	R1-1798	Piaggio	Porter	4 1/2 Jx13	6,25	63	96,80
13120	R1-1803	Fiat	Panda/Classic	5,00 Bx13	4,90	63	60,40
13121	R1-1838	Hyundai	i10 (Facelift)	4,00 Bx13	5,25	72	89,70
13122	R1-1902	Hyundai	i10	4 1/2 Jx13	5,25	63	91,20
14017	R1-993	Volkswagen	Golf III/Vento	6 Jx14	8,20	40	103,30
			Golf III Syncro	6 Jx14	8,20	40	
			Golf III Cabrio	6 Jx14	8,20	40	
			Polo III	6 Jx14	8,20	40	
14031	R1-878	Volkswagen	Corrado	6 Jx14	8,40	40	94,80
			Passat/Variant	6 Jx14	8,40	40	
14057	R1-1273	Seat	Toledo II/Leon	6 Jx14	7,90	45	94,80
		Skoda	Octavia/Tour	6 Jx14	7,90	45	
		Volkswagen	Golf IV	6 Jx14	7,90	45	
14073	R1-1278	Citroën	Berlingo I	5 1/2 Jx14	6,90	54	86,30
			Berlingo I	5 1/2 Jx14	6,90	54	
		Citroën Nfz.	Berlingo I	5 1/2 Jx14	6,90	54	

14110	R1-1077	Opel	Astra-G	5 1/2 Jx14	7,40	48	85,10
			Vectra-B	5 1/2 Jx14	7,40	48	
		Opel Nfz.	Astra-Van	5 1/2 Jx14	7,40	48	
14119	R1-1121	Fiat	Panda/Classic/4x4	5 1/2 Jx14	5,80	54	83,90
			Punto	5 1/2 Jx14	5,80	54	
14132	R1-1508	Opel	Corsa-C	5 1/2 Jx14	6,05	40	84,40
14133	R1-1548	Hyundai	Accent	5 Jx14	8,05	54	108,10
			Getz	5 Jx14	8,05	54	
			Getz	5 Jx14	8,05	54	
14138	R1-1148	Honda	Civic 3+4-türig	5 1/2 Jx14	7,20	48	87,50
14143	R1-1150	Citroën	C2	5 1/2 Jx14	5,55	54	83,80
			C3	5 1/2 Jx14	5,55	54	
		Peugeot	1007	5 1/2 Jx14	5,55	54	
			206 Plus	5 1/2 Jx14	5,55	54	
14144	R1-1464	Ford	Fiesta V	5 1/2 Jx14	7,00	54	82,10
			Fusion	5 1/2 Jx14	7,00	54	
		Ford Nfz.	Fiesta Van	5 1/2 Jx14	7,00	54	
		Mazda	Mazda 2	5 1/2 Jx14	7,00	54	
14147	R1-1436	Nissan	Micra	5 Jx14	5,30	56	97,30
14158	R1-1571	Hyundai	i10	5 Jx14	6,75	54	101,40
		Kia	Picanto	5 Jx14	6,75	54	
14162	R1-1596	Opel	Agila	5 Jx14	6,10	54	74,60
		Suzuki	Splash	5 Jx14	6,10	54	
			Swift	5 Jx14	6,10	54	
14163	R1-1601	Citroën	C1	4 1/2 Jx14	7,10	63	83,10
		Peugeot	107	4 1/2 Jx14	7,10	63	
		Toyota	Aygo	4 1/2 Jx14	7,10	63	
14165	R1-1588	Opel	Combo Combi/Tour	5 1/2 Jx14	6,55	48	90,70
		Opel Nfz.	Combo-C	5 1/2 Jx14	6,55	48	
			Corsa-C Van	5 1/2 Jx14	6,55	48	
14170	R1-1662	Opel	Adam	5 1/2 Jx14	6,20	54	72,60

14198	R1-1930	Toyota	Aygo II	4 1/2 Jx14	6,60	63	80,30
14201	R1-1954	Opel	Karl/Karl Rocks	5 Jx14	6,15	54	69,70
14202	R1-1957	Suzuki	Celerio	5 Jx14	5,50	48	96,50
14203	R1-1951	Mitsubishi	Attrage	5 Jx14	5,65	54	94,70
14204	R1-1988	Ford	Ka+	5 1/2 Jx14	6,35	54	70,30
14205	R1-2018	Seat	Ibiza	5 Jx14	6,85	54	74,20
		Skoda	Fabia IV	5 Jx14	6,85	54	
		Volkswagen	Polo VI	5 Jx14	6,85	54	
14206	R1-2032	Kia	Picanto III	5 1/2 Jx14	6,20	54	100,60
14210	R1-2063	Fiat	500/500C	5 1/2 Jx14	5,60	54	75,60
			Panda	5 1/2 Jx14	5,60	54	
		Ford	KA II	5 1/2 Jx14	5,60	54	
14211	R1-2085	Hyundai	i10	5 1/2 Jx14	6,35	54	83,60
14214	R1-2113	Dacia	Spring	4 1/2 Jx14	5,95	63	84,80
15017	R1-953	BMW	3-er Compact (E36/5)	6 Jx15	7,65	40	102,50
			3-er (E36)	6 Jx15	7,65	40	
			3-er Touring (E36)	6 Jx15	7,65	40	
			3-er Coupé/Cabrio (E36)	6 Jx15	7,65	40	
			Z3 Roadster (E36/7)	6 Jx15	7,65	40	
15019	R1-931	Audi	80 Cabrio/Coupé	6 Jx15	7,90	40	111,60
			80	6 Jx15	7,90	40	
15036	R1-1334	Peugeot	406	6 Jx15	8,90	40	88,20
15039	R1-1118	Fiat	Bravo	6 Jx15	6,85	40	99,90
			Multipla	6 Jx15	6,85	40	
15048	R1-1294	Opel	Astra-G	6 Jx15	7,45	40	104,40
			Astra-G Coupé/Cabrio	6 Jx15	7,45	40	
			Corsa-C	6 Jx15	7,45	40	
			Vectra-B	6 Jx15	7,45	40	
		Opel Nfz.	Astra-Van	6 Jx15	7,45	40	
15051	R1-1229	Audi	A3	6 Jx15	8,95	40	85,90
		Seat	Toledo II/Leon	6 Jx15	8,95	40	

14073	R1-1278	Citroën Nfz.	Berlingo I	5 1/2 Jx14	6,90	54	86,30
		Peugeot	Partner I Kombi	5 1/2 Jx14	6,90	54	
			Partner I Kombi	5 1/2 Jx14	6,90	54	
		Peugeot Nfz.	Partner I	5 1/2 Jx14	6,90	54	
Partner I	5 1/2 Jx14		6,90	54			
14082	R1-1399	Seat	Ibiza/Cordoba	5 Jx14	7,45	54	72,60
			Ibiza/ST	5 Jx14	7,45	54	
			Toledo IV	5 Jx14	7,45	54	
		Skoda	Fabia	5 Jx14	7,45	54	
	Fabia II		5 Jx14	7,45	54		
	Fabia III		5 Jx14	7,45	54		
	Rapid/Spaceback		5 Jx14	7,45	54		
	Roomster		5 Jx14	7,45	54		
	Skoda Nfz.	Fabia Praktika	5 Jx14	7,45	54		
		Praktik	5 Jx14	7,45	54		
	Volkswagen	Fox	5 Jx14	7,45	54		
		Polo IV	5 Jx14	7,45	54		
		Polo V	5 Jx14	7,45	54		
	14083	R1-1200	Seat	Ibiza/Cordoba	6 Jx14	8,20	
Skoda			Fabia	6 Jx14	8,20	45	
Skoda Nfz.			Fabia Praktika	6 Jx14	8,20	45	
Volkswagen			Fox	6 Jx14	8,20	45	
	Polo IV	6 Jx14	8,20	45			
14084	R1-1132	Renault	Clio II/Campus/Storia	5 1/2 Jx14	5,85	54	85,40
			Kangoo	5 1/2 Jx14	5,85	54	
			Megane	5 1/2 Jx14	5,85	54	
			Megane Break	5 1/2 Jx14	5,85	54	
			Megane Scenic	5 1/2 Jx14	5,85	54	
			Thalia/Symbol	5 1/2 Jx14	5,85	54	
			Twingo I	5 1/2 Jx14	5,85	54	
14091	R1-1320	Peugeot	206/SW	5 1/2 Jx14	6,15	54	79,70
			206 Plus	5 1/2 Jx14	6,15	54	
14106	R1-1330	Ford	Focus	5 1/2 Jx14	8,05	54	88,90
14108	R1-1354	Kia	Shuma II	5 1/2 Jx14	8,40	48	99,00
			Shuma I	5 1/2 Jx14	8,40	48	
			Shuma II	5 1/2 Jx14	8,40	48	

14170	R1-1662	Opel	Corsa-D	5 1/2 Jx14	6,20	54	72,60
			Corsa-E	5 1/2 Jx14	6,20	54	
		Opel Nfz.	Corsa-D Van	5 1/2 Jx14	6,20	54	
			Corsa-E Van	5 1/2 Jx14	6,20	54	
14172	R1-1638	Fiat	Idea	6 Jx14	6,20	45	90,80
		Lancia	Musa	6 Jx14	6,20	45	
			Ypsilon	6 Jx14	6,20	45	
14174	R1-1672	Skoda	Fabia II	6 Jx14	7,60	56	86,80
			Roomster	6 Jx14	7,60	56	
14175	R1-1637	Renault	Twingo II	5 1/2 Jx14	5,65	54	86,40
14176	R1-1689	Fiat	500/500C	5 1/2 Jx14	5,60	54	75,60
			Panda	5 1/2 Jx14	5,60	54	
14177	R1-1672	Ford	KA II	5 1/2 Jx14	5,60	54	86,40
			Praktik	6 Jx14	7,60	56	
14180	R1-1720	Mazda	Mazda 2	6 Jx14	6,70	40	104,50
14182	R1-1738	Ford	Fiesta VI	5 1/2 Jx14	7,05	54	79,90
			Fiesta VI (Facelift)	5 1/2 Jx14	7,05	54	
			Fiesta Van	5 1/2 Jx14	7,05	54	
		Ford Nfz.	Fiesta Van (Facelift)	5 1/2 Jx14	7,05	54	
			Pixo	4 1/2 Jx14	5,90	56	
14185	R1-1763	Nissan	Pixo	4 1/2 Jx14	5,90	56	93,20
14186	R1-1790	Hyundai	i20	5 1/2 Jx14	7,20	63	105,60
14187	R1-1794	Nissan	Micra	5 1/2 Jx14	7,20	48	90,50
14189	R1-1819	Kia	Picanto II	5 Jx14	6,20	54	101,20
14190	R1-1829	Seat	Mii	5 Jx14	5,80	54	73,80
			Skoda	Citigo	5 Jx14	5,80	
		Volkswagen	UP/e-UP/Cross-UP	5 Jx14	5,80	54	
14191	R1-1848	Toyota	Yaris III	5 Jx14	6,05	48	91,40
14192	R1-1831	Chevrolet	Spark	4 1/2 Jx14	6,50	56	97,40
14193	R1-1844	Dacia	Lodgy	5 1/2 Jx14	7,20	54	83,50
14194	R1-1860	Chevrolet	Aveo	5 1/2 Jx14	7,00	54	86,70
14195	R1-1900	Mitsubishi	Space Star	4 1/2 Jx14	5,65	56	93,30
14196	R1-1875	Piaggio	Porter	4,50 B x14	8,05	64	98,80
14197	R1-1903	Hyundai	i10	5 1/2 Jx14	6,35	54	80,90
14198	R1-1930	Citroën	C1 II	4 1/2 Jx14	6,60	63	80,30
		Peugeot	108	4 1/2 Jx14	6,60	63	

15051	R1-1229	Skoda	Octavia/Tour	6 Jx15	8,95	40	85,90
			Streetscooter	Work	6 Jx15	8,95	
		Work		6 Jx15	8,95	40	
		Work L		6 Jx15	8,95	40	
		Volkswagen	Bora/Variant	6 Jx15	8,95	40	
			Golf IV/Variant	6 Jx15	8,95	40	
			New Beetle/Cabrio	6 Jx15	8,95	40	
Polo IV Fun/Cross	6 Jx15		8,95	40			
15055	R1-1319	BMW	3-er Compact (E46)	6 1/2 Jx15	8,75	40	111,10
			3-er Lim/Touring (E46)	6 1/2 Jx15	8,75	40	
			3-er Coupé/Cabrio (E46)	6 1/2 Jx15	8,75	40	
15060	R1-1275	Mercedes	A-Klasse/A-Klasse-L	5 1/2 Jx15	8,30	40	89,90
15078	R1-1626	Fiat	Doblò	5 1/2 Jx15	6,70	48	105,20
		Fiat Nfz.	Doblò Cargo	5 1/2 Jx15	6,70	48	
15079	R1-1014	Audi	100/200	6 Jx15	8,85	40	97,20
			A4/Avant	6 Jx15	8,85	40	
			A6/Avant	6 Jx15	8,85	40	
			A6/Avant	6 Jx15	8,85	40	
		Volkswagen	Passat/Variant	6 Jx15	8,85	40	
			Passat/Variant	6 Jx15	8,85	40	
15092	R1-1318	Opel	Astra-G	6 Jx15	9,45	40	104,40
			Astra-G Coupé/Cabrio	6 Jx15	9,45	40	
			Combo Combi/Tour	6 Jx15	9,45	40	
			Corsa-C	6 Jx15	9,45	40	
			Vectra-B	6 Jx15	9,45	40	
			Combo-C	6 Jx15	9,45	40	
15092	R1-1318	Opel Nfz.	Corsa-C Van	6 Jx15	9,45	40	
			Corsa-C Van	6 Jx15	9,45	40	
15101	R1-1372	Citroën	C2	6 Jx15	7,00	40	91,30
			C3/C3 X-TR	6 Jx15	7,00	40	
			C3 Pluriel	6 Jx15	7,00	40	
			C4/C4-Coupé	6 Jx15	7,00	40	
		Peugeot	1007	6 Jx15	7,00	40	
			206/SW	6 Jx15	7,00	40	
			206 CC	6 Jx15	7,00	40	
			206 Plus	6 Jx15	7,00	40	
			307/SW/Break	6 Jx15	7,00	40	

MWD-Nr.	MW-AM Nr.	Fahrzeughersteller	Modellbezeichnung	Radabmessung	Gewicht pro Rad	Stk. pro Pal.	Preis in € ohne MwSt.
MWD-Ref.	MW-AM Ref.	Car producer	Car model	Wheel size	Weight p. wheel	Qty. p. Pal.	Price in € without TVA

MWD-Nr.	MW-AM Nr.	Fahrzeughersteller	Modellbezeichnung	Radabmessung	Gewicht pro Rad	Stk. pro Pal.	Preis in € ohne MwSt.
MWD-Ref.	MW-AM Ref.	Car producer	Car model	Wheel size	Weight p. wheel	Qty. p. Pal.	Price in € without TVA

MWD-Nr.	MW-AM Nr.	Fahrzeughersteller	Modellbezeichnung	Radabmessung	Gewicht pro Rad	Stk. pro Pal.	Preis in € ohne MwSt.
MWD-Ref.	MW-AM Ref.	Car producer	Car model	Wheel size	Weight p. wheel	Qty. p. Pal.	Price in € without TVA

Radnummern aufsteigend

15102	R1-1338	Ford	Fiesta V/ST150	6 Jx15	8,90	40	88,90
			Focus	6 Jx15	8,90	40	
		Ford Nfz.	Fiesta Van	6 Jx15	8,90	40	
15105	R1-1270	Nissan	Almera	6 Jx15	8,75	40	112,80
			Primera	6 Jx15	8,75	40	
15119	R1-1404	Mercedes Nfz.	Sprinter I	6 Jx15	13,40	40	124,10
		Volkswagen Nfz.	LT28/35	6 Jx15	13,40	40	
15122	R1-1159	Fiat	Stilo/Stilo Multi Wagon	6 1/2 Jx15	7,20	40	103,20
15124	R1-1402	Alfa Romeo	147	6 Jx15	7,30	40	107,10
15132	R1-1177	Honda	HR-V	5 1/2 JJx15	7,55	36	116,00
15133	R1-1176	Honda	CR-V	6 JJx15	9,80	36	129,00
15142	R1-1417	Mini	Mini One/Cooper/Cabrio	5 1/2 Jx15	6,80	48	106,80
			Mini One/Cooper/Cabrio	5 1/2 Jx15	6,80	48	
			Mini Clubman	5 1/2 Jx15	6,80	48	
15144	R1-1463	Opel	Astra-H	6 1/2 Jx15	8,20	40	92,50
			Astra-H GTC	6 1/2 Jx15	8,20	40	
			Meriva-B	6 1/2 Jx15	8,20	40	
			Signum	6 1/2 Jx15	8,20	40	
			Vectra-C	6 1/2 Jx15	8,20	40	
			Zafira-B	6 1/2 Jx15	8,20	40	
			Opel Nfz.	Astra-H/Van	6 1/2 Jx15	8,20	
		15145	R1-1507	Mazda	Mazda 6/Sport	6 JJx15	
			Mazda 6 (Facelift)	6 JJx15	9,30	88	
15149	R1-1435	Nissan	Micra/Micra CC	5 1/2 Jx15	6,40	48	108,70
			Micra	5 1/2 Jx15	6,40	48	
15153	R1-1469	Renault	Megane II	6 1/2 Jx15	8,60	40	97,80
			Megane II Scenic	6 1/2 Jx15	8,60	40	
15154	R1-1519	Skoda	Fabia/RS	6 Jx15	9,20	40	91,20
			Fabia II/Scout	6 Jx15	9,20	40	
			Roomster/Scout	6 Jx15	9,20	40	
		Skoda Nfz.	Fabia Praktika	6 Jx15	9,20	40	

15176	R1-1573	Kia	Cerato	6 Jx15	8,70	40	110,10
15177	R1-1575	Mitsubishi	Colt/CZ3/CZT	6 Jx15	7,05	40	116,30
			Colt CZC	6 Jx15	7,05	40	
		Smart	Forfour	6 Jx15	7,05	40	
15178	R1-1579	Renault	Clio III/Grandtour	5 1/2 Jx15	5,85	48	99,90
			Modus/Grand Modus	5 1/2 Jx15	5,85	48	
15179	R1-1580	Renault	Clio III/Grandtour	6 Jx15	5,85	40	101,90
			Modus/Grand Modus	6 Jx15	5,85	40	
15180	R1-1087	Citroën	C5	6 Jx15	8,90	40	102,70
			C5 Break	6 Jx15	8,90	40	
			Xsara	6 Jx15	8,90	40	
		Peugeot	306	6 Jx15	8,90	40	
			406	6 Jx15	8,90	40	
15185	R1-1593	Fiat	Punto/Grande Punto EVO	6 Jx15	6,65	40	88,70
15189	R1-1611	Renault	Clio III/Grandtour	6 Jx15	6,75	40	108,20
15190	R1-1607	Daihatsu	Charade	5 1/2 Jx15	8,20	48	101,80
			Toyota	Yaris II	5 1/2 Jx15	8,20	
15192	R1-1595	Suzuki	Swift	5 1/2 Jx15	6,80	48	89,00
15193	R1-1648	Opel	Adam	6 Jx15	8,35	40	85,90
			Corsa-D	6 Jx15	8,35	40	
			Corsa-E	6 Jx15	8,35	40	
		Opel Nfz.	Corsa-D Van	6 Jx15	8,35	40	
			Corsa-E Van	6 Jx15	8,35	40	
15195	R1-1651	Citroën	C3 II	6 Jx15	8,40	40	87,10
			C3 III	6 Jx15	8,40	40	
			C3 Picasso	6 Jx15	8,40	40	
			C-Elysee	6 Jx15	8,40	40	
			DS3	6 Jx15	8,40	40	
		Peugeot	207/SW	6 Jx15	8,40	40	
			208	6 Jx15	8,40	40	
			301	6 Jx15	8,40	40	

15214	R1-1712	Renault Nfz.	Kangoo II Rapid	6 Jx15	9,10	40	101,70
			Kangoo II Z.E.	6 Jx15	9,10	40	
15215	R1-1734	Renault	Fluence	6 1/2 Jx15	7,20	40	105,30
			Megane III/Coupé/Grandtour	6 1/2 Jx15	7,20	40	
			Megane III Scenic	6 1/2 Jx15	7,20	40	
15216	R1-1717	Opel	Agila	5 1/2 Jx15	6,80	48	100,30
			Suzuki	Splash	5 1/2 Jx15	6,80	
15217	R1-1730	Ford	Fiesta VI	6 Jx15	6,85	40	86,00
			Fiesta VI (Facelift)	6 Jx15	6,85	40	
		Ford Nfz.	Fiesta Van	6 Jx15	6,85	40	
			Fiesta Van (Facelift)	6 Jx15	6,85	40	86,00
15218	R1-1728	Nissan	Tiida	5 1/2 JJx15	7,80	48	89,70
15219	R1-1727	Seat	Ibiza/ST	6 Jx15	9,20	40	83,70
			Toledo IV	6 Jx15	9,20	40	
		Skoda	Fabia III	6 Jx15	9,20	40	
			Rapid/Spaceback	6 Jx15	9,20	40	
		Volkswagen	Polo V	6 Jx15	9,20	40	
15221	R1-1724	Dacia	Logan/MCV/Sandero/Stepway	6 Jx15	7,35	40	89,70
15222	R1-1783	Opel	Combo Combi/Tour	6 Jx15	8,20	40	98,20
			Opel Nfz.	Combo-C	6 Jx15	8,20	
					Corsa-C Van	6 Jx15	
15223	R1-1756	Toyota	IQ	5 Jx15	7,30	48	97,00
15226	R1-1751	Kia	Soul	6 Jx15	7,80	40	90,90
15227	R1-1760	Audi	A1/Sportback	6 Jx15	7,55	40	93,30
15230	R1-1766	Mazda	Mazda 3	6 Jx15	7,80	40	108,50
15232	R1-1741	Fiat	Doblò Heavy	6 Jx15	7,45	48	100,90
			Fiat Nfz.	Doblò Cargo	6 Jx15	7,45	
		Opel Nfz.	Combo-D	6 Jx15	7,45	48	
15233	R1-1743	Fiat	500L	6 Jx15	6,65	40	89,30
			Doblò Light	6 Jx15	6,65	40	
			Fiat Nfz.	Doblò Cargo	6 Jx15	6,65	

15154	R1-1519	Skoda Nfz.	Praktik	6 Jx15	9,20	40	91,20	
15155	R1-1489	Seat	Altea/Altea XL Kombi	6 Jx15	8,75	40	83,80	
			Altea Freetrack	6 Jx15	8,75	40		
			Leon II	6 Jx15	8,75	40		
			Toledo III	6 Jx15	8,75	40		
		Skoda	Octavia II	6 Jx15	8,75	40		
		Volkswagen	Golf V	6 Jx15	8,75	40		
			Golf V Variant	6 Jx15	8,75	40		
			Golf V Plus/Cross	6 Jx15	8,75	40		
			Golf VI Cabrio	6 Jx15	8,75	40		
			Golf VI/Plus/Cross	6 Jx15	8,75	40		
			Golf VI Variant	6 Jx15	8,75	40		
		Jetta	6 Jx15	8,75	40			
		Jetta	6 Jx15	8,75	40			
		Touran/Cross	6 Jx15	8,75	40			
15156	R1-1478	Opel	Meriva-A	6 Jx15	8,85	40	97,90	
			Tigra Twin Top	6 Jx15	8,85	40		
15157	R1-1514	Chevrolet	Epica	6 Jx15	8,40	40	112,30	
			Evanda	6 Jx15	8,40	40		
15159	R1-1475	Alfa Romeo	MiTo/Turismo	6 Jx15	9,15	48	99,00	
			Fiat	500/500C	6 Jx15	9,15		48
				500e	6 Jx15	9,15		48
		Idea	6 Jx15	9,15	48			
		Ford	KA II	6 Jx15	9,15	48		
		Lancia	Musa	6 Jx15	9,15	48		
Ypsilon	6 Jx15		9,15	48				
15163	R1-1522	Ford	C-Max	6 Jx15	6,80	40	91,00	
			Focus II	6 Jx15	6,80	40		
15164	R1-1559	Opel	Astra-H	6 1/2 Jx15	6,65	40	92,90	
			Astra-H GTC	6 1/2 Jx15	6,65	40		
15165	R1-1421	Ford	Transit Tourneo/Euroline/Nugget	5 1/2 Jx15	10,30	48	134,10	
			Transit Tourneo	5 1/2 Jx15	10,30	48		
		Ford Nfz.	Transit	5 1/2 Jx15	10,30	48		
			Transit	5 1/2 Jx15	10,30	48		
15173	R1-1567	Mercedes	A-Klasse	6 Jx15	6,50	48	96,20	
			B-Klasse	6 Jx15	6,50	48		
15196	R1-1630	Nissan	Note	5 1/2 Jx15	6,40	48	108,60	
15198	R1-1643	Citroën	Jumpy II Kombi (Facelift)	6 1/2 Jx15	9,55	40	105,40	
			Citroën Nfz.	Jumpy II (Facelift)	6 1/2 Jx15	7,10		40
			Fiat	Scudo Kombi (Facelift)	6 1/2 Jx15	7,10		40
			Fiat Nfz.	Scudo (Facelift)	6 1/2 Jx15	7,10		40
			Peugeot	Expert I Kombi	6 1/2 Jx15	7,10		40
			Peugeot Nfz.	Expert I (Facelift)	6 1/2 Jx15	7,10		40
15202	R1-1697	Smart	Fortwo II	4 1/2 Jx15	6,20	48	96,00	
15203	R1-1698	Smart	Fortwo II	5 1/2 Jx15	6,65	48	99,20	
15204	R1-1692	Toyota	Auris	6 Jx15	8,05	40	102,30	
15205	R1-1684	Dacia	Dokker/Express	6 Jx15	7,95	40	95,80	
			Logan/MCV/Sandero/Stepway	6 Jx15	7,95	40		
			Logan Express/Pick Up	6 Jx15	7,95	40		
			Sandero Stepway	6 Jx15	7,95	40		
			Nissan	Micra IV	6 Jx15	7,95		40
15206	R1-1693	Hyundai	i30/i30cw	5 1/2 Jx15	7,70	48	89,70	
			Cee d/Pro Cee d/Sporty Wagon	5 1/2 Jx15	7,70	48		
15207	R1-1700	Citroën	C4	6 1/2 Jx15	7,70	40	91,80	
			DS4	6 1/2 Jx15	7,70	40		
			Peugeot	308/SW/CC	6 1/2 Jx15	7,70		40
15210	R1-1706	Fiat	Sedici	6 Jx15	7,00	40	104,40	
			Suzuki	Swift 1600 Sport	6 Jx15	7,00		40
				SX-4/SX4-Classic	6 Jx15	7,00		40
15211	R1-1681	Citroën	Nemo Kombi	6 Jx15	7,05	40	100,30	
			Citroën Nfz.	Nemo Kastenwagen	6 Jx15	7,05		40
		Fiat	Linea	6 Jx15	7,05	40		
			Qubo	6 Jx15	7,05	40		
		Fiat Nfz.	Fiorino	6 Jx15	7,05	40		
		Peugeot	Bipper Tepee	6 Jx15	7,05	40		
		Peugeot Nfz.	Bipper	6 Jx15	7,05	40		
15213	R1-1735	Citroën	Berlingo II	6 1/2 Jx15	8,25	40	97,60	
			Citroën Nfz.	Berlingo II	6 1/2 Jx15	8,25		40
		Peugeot	Partner II Tepee	6 1/2 Jx15	8,25	40		
		Peugeot Nfz.	Partner II	6 1/2 Jx15	8,25	40		
		Mercedes Nfz.	Citan/Tourer	6 Jx15	9,10	40		
15214	R1-1712	Renault	Kangoo II	6 Jx15	9,10	40	101,70	
15234	R1-1780	Suzuki	Swift	5 Jx15	7,10	48	97,90	
15237	R1-1796	Ford Nfz.	Transit Connect	6 Jx15	7,85	40	92,80	
			Volkswagen	Caddy Life	6 Jx15	7,85		40
			Caddy Generation Four/Beach	6 Jx15	7,85	40		
			Caddy	6 Jx15	7,85	40		
		Volkswagen Nfz.	Caddy/Kombi	6 Jx15	7,85	40		
			Caddy/Maxi	6 Jx15	7,85	40		
	Caddy Cargo	6 Jx15	7,85	40				
15238	R1-1833	Nissan Nfz.	Cabstar	5 Jx15	10,25	40	114,50	
		Renault Nfz.	Maxity	5 Jx15	10,25	40		
15239	R1-1813	Mercedes	A-Klasse	6 1/2 Jx15	7,85	40	93,50	
			B-Klasse	6 1/2 Jx15	7,85	40		
15240	R1-1807	Subaru	Trezia	5 1/2 Jx15	8,50	48	109,60	
		Toyota	Verso S	5 1/2 Jx15	8,50	48		
15241	R1-1817	Toyota	Yaris III	5 Jx15	6,80	48	92,50	
15242	R1-1805	Citroën	C-Zero	4 Jx15	7,10	48	115,70	
			Mitsubishi	i-Miev	4 Jx15	7,10		48
			Peugeot	iOn	4 Jx15	7,10		48
15243	R1-1806	Citroën	C-Zero	5 Jx15	7,20	48	115,00	
			Mitsubishi	i-Miev	5 Jx15	7,20		48
			Peugeot	iOn	5 Jx15	7,20		48
15244	R1-1804	Lancia	Ypsilon	6 Jx15	6,75	48	104,90	
15245	R1-1865	Renault	Zoe	6 Jx15	6,50	40	91,40	
15246	R1-1828	Kia	Rio III	5 1/2 Jx15	7,55	48	104,60	
15247	R1-1826	Fiat	Panda/4x4/Cross/City Cross	6 Jx15	7,00	48	94,90	
15248	R1-1847	Ford	B-Max	6 Jx15	6,75	40	87,00	
15249	R1-1845	Dacia	Dokker/Express/Stepway	6 Jx15	7,40	40	91,90	
			Lodgy/Stepway	6 Jx15	7,40	40		
15250	R1-1843	Chevrolet	Aveo	6 Jx15	8,10	40	90,70	
15251	R1-1846	Chevrolet	Aveo	6 Jx15	8,50	40	83,00	
15253	R1-1855	Dacia	Sandero (Mj.21)	6 Jx15	6,05	40	94,90	
		Renault	Clio IV/Grandtour	6 Jx15	6,05	40		
15255	R1-1850	Seat	Leon III	6 Jx15	7,25	40	86,80	
			Skoda	Octavia III	6 Jx15	7,25		40
			Volkswagen	Golf VII	6 Jx15	7,25		40
			Golf VII Variant/Sportsvan	6 Jx15	7,25	40		

MWD-Nr.	MW-AM Nr.	Fahrzeughersteller	Modellbezeichnung	Radabmessung	Gewicht pro Rad	Stk. pro Pal.	Preis in € ohne MwSt.
MWD-Ref.	MW-AM Ref.	Car producer	Car model	Wheel size	Weight p. wheel	Qty. p. Pal.	Price in € without TVA

MWD-Nr.	MW-AM Nr.	Fahrzeughersteller	Modellbezeichnung	Radabmessung	Gewicht pro Rad	Stk. pro Pal.	Preis in € ohne MwSt.
MWD-Ref.	MW-AM Ref.	Car producer	Car model	Wheel size	Weight p. wheel	Qty. p. Pal.	Price in € without TVA

MWD-Nr.	MW-AM Nr.	Fahrzeughersteller	Modellbezeichnung	Radabmessung	Gewicht pro Rad	Stk. pro Pal.	Preis in € ohne MwSt.
MWD-Ref.	MW-AM Ref.	Car producer	Car model	Wheel size	Weight p. wheel	Qty. p. Pal.	Price in € without TVA

Radnummern aufsteigend

15256	R1-1863	Ford Nfz.	Transit/Transit Custom	6 1/2 Jx15	10,10	40	115,90
15258	R1-1873	Dacia	Logan II/MCV II/Sandero II	6 Jx15	6,35	40	95,20
15259	R1-1923	Ford	EcoSport	6 Jx15	6,35	40	95,70
15260	R1-1888	Toyota	Auris II/Touring Sport	6 Jx15	8,05	40	100,60
15261	R1-1889	Citroën	C3 III	6 1/2 Jx15	6,50	40	93,70
			C3 Aircross	6 1/2 Jx15	6,50	40	
			C4 Cactus	6 1/2 Jx15	6,50	40	
		Opel	Crossland-X	6 1/2 Jx15	6,50	40	
		Peugeot	2008	6 1/2 Jx15	6,50	40	
15262	R1-1894	Renault Nfz.	Kangoo II Rapid	6 Jx15	8,10	40	118,10
15263	R1-1881	Peugeot	308/SW	6 1/2 Jx15	10,40	40	89,10
15264	R1-1891	Nissan	Note II	5 1/2 Jx15	6,90	48	97,40
15265	R1-1901	Hyundai	ix20	6 Jx15	7,80	48	92,90
15268	R1-1937	Renault	Twingo III/e-Twingo	5 Jx15	5,35	48	94,50
15269	R1-1938	Renault	Twingo III/e-Twingo	5 1/2 Jx15	5,75	48	93,60
15270	R1-1935	Smart	Fortwo III (C453)	5 Jx15	5,40	48	93,30
			Forfour II (W453)	5 Jx15	5,40	48	
15271	R1-1936	Smart	Fortwo III (C453)	5 1/2 Jx15	5,70	48	94,60
			Forfour II (W453)	5 1/2 Jx15	5,70	48	
15272	R1-1898	Nissan	NV200 electric	6 Jx15	5,70	40	96,10
15273	R1-1908	Citroën Nfz.	Jumper I	6 Jx15	10,10	40	108,90
			Jumper I (Facelift)	6 Jx15	10,10	40	
			Jumper II	6 Jx15	10,10	40	
			Jumper II (Facelift)	6 Jx15	10,10	40	
			Jumper III	6 Jx15	10,10	40	
		Fiat	Ducato Kombi	6 Jx15	10,10	40	
			Ducato II Kombi	6 Jx15	10,10	40	
			Ducato III Kombi	6 Jx15	10,10	40	
		Fiat Nfz.	Ducato	6 Jx15	10,10	40	
			Ducato I (Facelift)	6 Jx15	10,10	40	
			Ducato II	6 Jx15	10,10	40	

15281	R1-1941	Fiat Nfz.	Ducato II	6 Jx15	10,45	40	108,90
			Ducato II (Facelift)	6 Jx15	10,45	40	
			Ducato III/Maxi	6 Jx15	10,45	40	
		Iveco Nfz.	Daily S2000	6 Jx15	10,45	40	
			Peugeot	Boxer Kombi	6 Jx15	10,45	
		Boxer Kombi		6 Jx15	10,45	40	
		Boxer II Kombi		6 Jx15	10,45	40	
		Boxer III Kombi		6 Jx15	10,45	40	
		Peugeot Nfz.	Boxer I	6 Jx15	10,45	40	
			Boxer I (Facelift)	6 Jx15	10,45	40	
			Boxer II	6 Jx15	10,45	40	
			Boxer II (Facelift)	6 Jx15	10,45	40	
			Boxer III	6 Jx15	10,45	40	
Streetscooter	Work L		6 Jx15	10,45	40		
15282	R1-1942	Hyundai	Bayon	6 Jx15	7,60	40	93,70
			i20 II	6 Jx15	7,60	40	
15284	R1-1949	Honda	Jazz III	6 Jx15	7,10	48	100,60
15285	R1-1955	Renault	Megane IV/Grandtour	6 Jx15	7,25	40	89,00
15286	R1-1952	Opel	Astra-K/Sports Tourer	6 Jx15	7,75	40	88,90
15288	R1-1963	Fiat	Tipo	6 Jx15	7,20	48	88,80
15289	R1-1972	Nissan Nfz.	Cabstar	5 Jx15	10,40	40	114,60
		Renault Nfz.	Maxity	5 Jx15	10,40	40	
15290	R1-1975	Toyota	Hilux	6 Jx15	11,40	40	120,80
15291	R1-1977	Suzuki	Baleno	5 Jx15	6,55	48	92,20
15292	R1-1989	Ford	Ka+	6 Jx15	8,25	40	79,20
15293	R1-2008	Ford	Fiesta VII	6 Jx15	8,25	40	79,60
15294	R1-2010	Hyundai	i30//Kombi	6 Jx15	7,38	40	90,60
		Kia	Cee'd/Sporty Wagon	6 Jx15	7,38	40	
15295	R1-2014	Hyundai	Ioniq Hybrid	6 Jx15	7,15	40	95,50
15296	R1-2002	Kia	Rio IV	6 Jx15	6,80	40	97,70
			Stonic	6 Jx15	7,70	40	

16003	R1-1640	Peugeot	207/SW	6 Jx16	7,20	30	111,10
16005	R1-1361	Audi	A6/Avant	6 Jx16	9,00	40	118,70
		Skoda	Superb	6 Jx16	9,00	40	
		Volkswagen	Passat/Variant	6 Jx16	9,00	40	
16027	R1-1187	Renault	Laguna II/Grandtour	6 1/2 Jx16	8,40	30	103,90
16028	R1-1198	Mercedes	C-Klasse	7 Jx16	8,10	24	117,50
			C-Klasse/Sportcoupé	7 Jx16	8,10	24	
			CLC Sportcoupé (Facelift)	7 Jx16	8,10	24	
			CLK	7 Jx16	8,10	24	
			CLK	7 Jx16	8,10	24	
16029	R1-1490	BMW	3-er Compact (E36/5)	7 Jx16	8,65	30	123,40
			3-er (E36)	7 Jx16	8,65	30	
			3-er Touring (E36)	7 Jx16	8,65	30	
			3-er Coupé/Cabrio (E36)	7 Jx16	8,65	30	
			3-er Compact (E46)	7 Jx16	8,65	30	
			3-er Lim/Touring (E46)	7 Jx16	8,65	30	
			3-er 4x4 (E46)	7 Jx16	8,65	30	
			3-er Coupé/Cabrio (E46)	7 Jx16	8,65	30	
			Z3 Roadster/Coupe (E36/7/8)	7 Jx16	8,65	30	
16034	R1-1373	Nissan Nfz.	Primastar	6 Jx16	10,65	30	114,50
		Opel	Vivaro Life	6 Jx16	10,65	30	
		Opel Nfz.	Vivaro II	6 Jx16	10,65	30	
		Renault Nfz.	Trafic II	6 Jx16	10,65	30	
16036	R1-1557	Ford	C-Max	6 1/2 Jx16	9,65	30	100,70
			Focus II/CC/ST220	6 1/2 Jx16	9,65	30	
			Mondeo (Facelift) / ST220	6 1/2 Jx16	9,65	30	
16038	R1-1468	Renault	Megane II	6 1/2 Jx16	9,85	30	104,20
			Megane II Scenic	6 1/2 Jx16	9,85	30	
16043	R1-1491	Audi	A3/Cabrio/Sportback	6 1/2 Jx16	9,55	30	94,80
		Seat	Altea/Altea XL Kombi	6 1/2 Jx16	9,55	30	
			Altea Freetrack/4x4	6 1/2 Jx16	9,55	30	

15273	R1-1908	Fiat Nfz.	Ducato II (Facelift)	6 Jx15	10,10	40	108,90
			Ducato III	6 Jx15	10,10	40	
		Iveco Nfz.	Daily S2000	6 Jx15	10,10	40	
		Opel Nfz.	Movano III Cargo	6 Jx15	10,10	40	
			Boxer Kombi	6 Jx15	10,10	40	
			Boxer Kombi	6 Jx15	10,10	40	
			Boxer II Kombi	6 Jx15	10,10	40	
		Peugeot Nfz.	Boxer III Kombi	6 Jx15	10,10	40	
			Boxer I	6 Jx15	10,10	40	
			Boxer I (Facelift)	6 Jx15	10,10	40	
Boxer II	6 Jx15		10,10	40			
Boxer II (Facelift)	6 Jx15		10,10	40			
		Boxer III	6 Jx15	10,10	40		
15274	R1-1915	Mini	Mini II One/Cabrio/Cooper (F55/56/57)	5 1/2 Jx15	6,95	48	98,90
15275	R1-1931	Citroën	C1 II	4 1/2 Jx15	6,95	56	95,70
		Peugeot	108	4 1/2 Jx15	6,95	56	
		Toyota	Aygo II	4 1/2 Jx15	6,95	56	
15277	R1-1925	Ford	Tourneo Courier	6 Jx15	9,00	40	96,40
		Ford Nfz.	Transit Courier	6 Jx15	9,00	40	
15278	R1-1929	Mazda	Mazda 2	5 1/2 Jx15	8,00	40	108,50
15279	R1-1914	Kia	Venga	6 Jx15	5,50	48	99,90
15281	R1-1941	Citroën	Jumper I Kombi	6 Jx15	10,45	40	108,90
			Jumper I Kombi (Facelift)	6 Jx15	10,45	40	
			Jumper II Kombi	6 Jx15	10,45	40	
			Jumper III Kombi	6 Jx15	10,45	40	
		Citroën Nfz.	Jumper I	6 Jx15	10,45	40	
			Jumper I (Facelift)	6 Jx15	10,45	40	
			Jumper II	6 Jx15	10,45	40	
			Jumper II (Facelift)	6 Jx15	10,45	40	
			Jumper III	6 Jx15	10,45	40	
		Fiat	Ducato Kombi	6 Jx15	10,45	40	
			Ducato II Kombi	6 Jx15	10,45	40	
			Ducato III Kombi	6 Jx15	10,45	40	
		Fiat Nfz.	Ducato	6 Jx15	10,45	40	
Ducato I (Facelift)	6 Jx15		10,45	40			

15298	R1-2013	Suzuki	Ignis III	5 Jx15	6,23	48	86,80
			Swift	5 Jx15	6,23	48	
15299	R1-2019	Audi	A1 Sportback	5 1/2 Jx15	6,57	48	83,30
		Seat	Ibiza	5 1/2 Jx15	6,57	48	
		Skoda	Fabia IV	5 1/2 Jx15	6,57	48	
		Volkswagen	Polo VI	5 1/2 Jx15	6,57	48	
15301	R1-2045	Mitsubishi	Colt	6 Jx15	6,25	48	96,80
		Renault	Clío V	6 Jx15	6,25	48	
15302	R1-2056	Citroën	Berlingo III M	6 1/2 Jx15	10,40	40	102,60
		Citroën Nfz.	Berlingo III M	6 1/2 Jx15	10,40	40	
		Fiat Nfz.	Doblò Cargo (Mj. 2022)	6 1/2 Jx15	10,40	40	
		Opel	Combo Life	6 1/2 Jx15	10,40	40	
		Opel Nfz.	Combo Cargo	6 1/2 Jx15	10,40	40	
		Peugeot	Rifter L1	6 1/2 Jx15	10,40	40	
		Peugeot Nfz.	Partner III L1	6 1/2 Jx15	10,40	40	
		Toyota	ProAce City Verso	6 1/2 Jx15	10,40	40	
Toyota Nfz.	ProAce City	6 1/2 Jx15	10,40	40			
15303	R1-2060	Opel	Corsa-F	6 Jx15	6,15	40	97,60
		Peugeot	208 II	6 Jx15	6,15	40	
15304	R1-2065	Skoda	Kamiq	6 Jx15	6,80	48	83,80
			Scala	6 Jx15	6,80	48	
15305	R1-2081	Renault	Zoe (Facelift)	6 Jx15	7,10	40	100,90
15308	R1-2074	Suzuki	Jimny	5 1/2 Jx15	7,50	40	122,80
			Jimny (Mj. 2019)	5 1/2 Jx15	7,50	40	
15309	R1-2077	Toyota	Corolla/Limousine/Touring Sport	6 1/2 Jx15	7,35	40	104,20
15310	R1-2087	Seat	Leon IV/Sportstourer	6 Jx15	6,95	40	84,10
		Volkswagen	Golf VIII/Variant	6 Jx15	6,95	40	
15311	R1-2096	Mazda	Mazda 2 Hybrid	6 Jx15	7,00	48	105,90
			Toyota	Yaris IV	6 Jx15	7,00	
15312	R1-2097	Honda	Jazz IV Hybrid	6 Jx15		40	109,10
15313	R1-2099	Mercedes Nfz.	Citan II/Citan II Tourer	6 Jx15	7,55	40	99,70
			Nissan Nfz.	Townstar	6 Jx15	7,55	
		Renault	Kangoo III	6 Jx15	7,55	40	
			Renault Nfz.	Kangoo III Rapid	6 Jx15	7,55	
15314	R1-2100	Renault Nfz.	Express	6 Jx15	7,55	40	98,80
15315	R1-2101	Dacia	Lodgy/Stepway	6 Jx15	7,30	40	99,40

16043	R1-1491	Seat	Leon II	6 1/2 Jx16	9,55	30	94,80
			Toledo III	6 1/2 Jx16	9,55	30	
		Skoda	Octavia II	6 1/2 Jx16	9,55	30	
			Volkswagen	Golf V	6 1/2 Jx16	9,55	
		Golf V Variant		6 1/2 Jx16	9,55	30	
		Golf V Plus/Cross		6 1/2 Jx16	9,55	30	
		Golf VI Cabrio		6 1/2 Jx16	9,55	30	
		Golf VI/Plus/Cross		6 1/2 Jx16	9,55	30	
		Golf VI Variant		6 1/2 Jx16	9,55	30	
				Jetta	6 1/2 Jx16	9,55	
		Jetta	6 1/2 Jx16	9,55	30		
		Touran	6 1/2 Jx16	9,55	30		
16044	R1-1492	Audi	A3/Cabrio/Sportback	6 Jx16	9,50	30	95,60
			Seat	Altea/Altea XL Kombi	6 Jx16	9,50	
		Altea Freetrack/4x4		6 Jx16	9,50	30	
		Leon II		6 Jx16	9,50	30	
		Toledo III		6 Jx16	9,50	30	
		Skoda		Octavia II/Scout/RS	6 Jx16	9,50	
			Superb II/Combi	6 Jx16	9,50	30	
			Yeti	6 Jx16	9,50	30	
			Volkswagen	Golf V	6 Jx16	9,50	
		Golf V Variant		6 Jx16	9,50	30	
		Golf V Plus/Cross		6 Jx16	9,50	30	
		Golf VI Cabrio		6 Jx16	9,50	30	
		Golf VI/Plus/Cross		6 Jx16	9,50	30	
				Golf VI Variant	6 Jx16	9,50	
		Jetta	6 Jx16	9,50	30		
		Jetta	6 Jx16	9,50	30		
		Touran/Cross	6 Jx16	9,50	30		
16045	R1-1483	Fiat	Croma	6 1/2 Jx16	9,00	25	107,90
			Saab	9-3/9-3X	6 1/2 Jx16	9,00	
				9-3 Cabrio	6 1/2 Jx16	9,00	
16050	R1-1470	Citroën	C8	7 Jx16	9,65	30	114,70
			Fiat	Ulysse	7 Jx16	9,65	
		Lancia	Phedra	7 Jx16	9,65	30	
		Peugeot	807	7 Jx16	9,65	30	

MWD-Nr.	MW-AM Nr.	Fahrzeughersteller	Modellbezeichnung	Radabmessung	Gewicht pro Rad	Stk. pro Pal.	Preis in € ohne MwSt.
MWD-Ref.	MW-AM Ref.	Car producer	Car model	Wheel size	Weight p. wheel	Qty. p. Pal.	Price in € without TVA

MWD-Nr.	MW-AM Nr.	Fahrzeughersteller	Modellbezeichnung	Radabmessung	Gewicht pro Rad	Stk. pro Pal.	Preis in € ohne MwSt.
MWD-Ref.	MW-AM Ref.	Car producer	Car model	Wheel size	Weight p. wheel	Qty. p. Pal.	Price in € without TVA

MWD-Nr.	MW-AM Nr.	Fahrzeughersteller	Modellbezeichnung	Radabmessung	Gewicht pro Rad	Stk. pro Pal.	Preis in € ohne MwSt.
MWD-Ref.	MW-AM Ref.	Car producer	Car model	Wheel size	Weight p. wheel	Qty. p. Pal.	Price in € without TVA

Radnummern aufsteigend

16055	R1-1529	Volkswagen	T5 Multivan/California/Caravelle	6 1/2 Jx16	11,30	30	110,90
			T6 Multivan/California/Caravelle	6 1/2 Jx16	11,30	30	
		Volkswagen Nfz.	T5 Transporter	6 1/2 Jx16	11,30	30	
			T6/T6.1 Transporter	6 1/2 Jx16	11,30	30	
16057	R1-1560	Opel	Astra-H	6 1/2 Jx16	8,20	40	107,30
			Astra-H GTC/Twintop	6 1/2 Jx16	8,20	40	
			Meriva-B	6 1/2 Jx16	8,20	40	
			Zafira-B	6 1/2 Jx16	8,20	40	
		Opel Nfz.	Astra-H/Van	6 1/2 Jx16	8,20	40	
			Meriva-B Van	6 1/2 Jx16	8,20	40	
16060	R1-1482	Volkswagen	Touareg	7 Jx16	11,90	30	173,10
16065	R1-1568	BMW	5-er (E60)	7 Jx16	10,25	40	126,80
			5-er Touring (E61)	7 Jx16	10,25	40	
16068	R1-1576	Mercedes	A-Klasse	6 Jx16	7,45	48	108,60
			B-Klasse	6 Jx16	7,45	48	
16070	R1-1577	Volvo	C30	6 1/2 Jx16	9,80	30	115,90
			S40/V50	6 1/2 Jx16	9,80	30	
			V40	6 1/2 Jx16	9,80	30	
			V40 Cross Country	6 1/2 Jx16	9,80	30	
16072	R1-1347	Iveco Nfz.	Iveco Daily S2000	5 JKx16	12,70	36	125,00
16074	R1-1582	Peugeot	307/SW/Break/CC	6 1/2 Jx16	13,10	30	106,50
16075	R1-1589	Citroën	C4/C4-Coupé	6 1/2 Jx16	9,70	30	
			C5/C5 Break	6 1/2 Jx16	9,70	30	
16077	R1-1597	Volkswagen	EOS	6 1/2 Jx16	9,65	30	100,90
			Passat/Variant	6 1/2 Jx16	9,65	30	
			Passat/Variant	6 1/2 Jx16	9,65	30	
			Scirocco III	6 1/2 Jx16	9,65	30	
16078	R1-1598	BMW	3-er (E90)	7 Jx16	8,30	40	127,50
			3-er Coupé/Cabrio (E92/93)	7 Jx16	8,30	40	
			3-er Touring (E91)	7 Jx16	8,30	40	

16098	R1-1675	Fiat Nfz.	Scudo II Kasten	7 Jx16	13,70	30	118,40
			Peugeot	Expert II Tepee	7 Jx16	13,70	
		Peugeot Nfz.	Expert II	7 Jx16	13,70	30	
			Toyota Nfz.	ProAce	7 Jx16	13,70	
16102	R1-1696	Mercedes	C-Klasse	6 Jx16	7,40	40	101,20
16104	R1-1703	BMW	1-er (E87)	6 1/2 Jx16	7,20	40	118,80
			1-er Coupé/Cabrio (E82/88)	6 1/2 Jx16	7,20	40	
			1-er (E87)	6 1/2 Jx16	7,20	40	
			1-er Coupé/Cabrio (E82/88)	6 1/2 Jx16	7,20	40	
			1-er Coupé/Cabrio (E82/88)	6 1/2 Jx16	7,20	40	
16105	R1-1704	BMW	1-er (E87)	7 Jx16	7,40	40	113,40
			1-er Coupé/Cabrio (E82/88)	7 Jx16	7,40	40	
			1-er (E87)	7 Jx16	7,40	40	
			1-er Coupé/Cabrio (E82/88)	7 Jx16	7,40	40	
			1-er Coupé/Cabrio (E82/88)	7 Jx16	7,40	40	
16106	R1-1705	BMW	3-er (E90)	7 Jx16	7,95	24	121,60
			3-er Coupé/Cabrio (E92/93)	7 Jx16	7,95	24	
			3-er Touring (E91)	7 Jx16	7,95	24	
			3-er xDrive (E90)	7 Jx16	7,95	24	
			3-er Lim/Touring (E90/91)	7 Jx16	7,95	24	
			3-er Coupé/Cabrio (E93)	7 Jx16	7,95	24	
			3-er Coupé/Cabrio (E93)	7 Jx16	7,95	24	
16107	R1-1702	Audi	A4/Avant	7 Jx16	8,90	30	99,90
16111	R1-1740	Nissan	Qashqai	6 1/2 Jx16	8,55	30	120,60
16114	R1-1670	Renault	Laguna III/Grandtour	7 Jx16	7,75	30	115,10
			Latitude	7 Jx16	7,75	30	
16115	R1-1707	Ford	C-Max	6 1/2 Jx16	9,70	30	92,60
			C-Max/Grand C-Max	6 1/2 Jx16	9,70	30	
			Focus II/CC	6 1/2 Jx16	9,70	30	
			Focus III	6 1/2 Jx16	9,70	30	
			Focus IV	6 1/2 Jx16	9,70	30	

16133	R1-1754	Skoda	Superb II/Combi	7 Jx16	9,45	36	107,70	
			Yeti	7 Jx16	9,45	36		
16134	R1-1744	Toyota	Avensis III	6 1/2 Jx16	10,75	30	123,80	
			Prius Plus	6 1/2 Jx16	10,75	30		
			Verso/Verso Life	6 1/2 Jx16	10,75	30		
16137	R1-1758	Citroën	C4	7 Jx16	7,70	30	109,30	
			DS4	7 Jx16	7,70	30		
16141	R1-1880	Citroën	C4 Aircross	6 1/2 Jx16	9,20	30	129,80	
			Mitsubishi	Eclipse Cross	6 1/2 Jx16	9,20		30
		Peugeot	Outlander III	6 1/2 Jx16	9,20	30		
			4008	6 1/2 JJx16	9,20	30		
16142	R1-1767	Mazda	Mazda 3	6 1/2 Jx16	9,20	30	119,80	
16143	R1-1776	Chevrolet	Cruze	6 1/2 Jx16	8,15	30	103,00	
			Opel	Astra-J/Sports-Tourer	6 1/2 Jx16	8,15		30
			Opel Nfz.	Astra-J Van	6 1/2 Jx16	8,15		30
16144	R1-1777	Chevrolet	Cruze	6 1/2 Jx16	8,85	30	103,90	
			Orlando	6 1/2 Jx16	8,85	30		
			Volt	6 1/2 Jx16	8,85	30		
			Opel	Ampera	6 1/2 Jx16	8,85		30
			Ampera e-plus	6 1/2 Jx16	8,85	30		
		Opel Nfz.	Astra-J/Sports-Tourer	6 1/2 Jx16	8,85	30		
			Insignia II Grand Sport/Sports Tourer	6 1/2 Jx16	8,85	30		
			Zafira-C Tourer	6 1/2 Jx16	8,85	30		
			Astra-J Van	6 1/2 Jx16	8,85	30		
			Dacia	Duster	6 1/2 Jx16	9,30		30
16145	R1-1779	Dacia	Duster	6 1/2 Jx16	9,30	30	100,70	
			Duster	6 1/2 Jx16	9,30	30		
16146	R1-1770	Hyundai	i30/i30cw	6 Jx16	8,60	30	100,10	
16147	R1-1765	Nissan Nfz.	NV400	6 1/2 Jx16	8,60	30	126,00	
			Opel Nfz.	Movano II	6 1/2 Jx16	8,60		30
		Renault Nfz.	Master/Master Z.E.	6 1/2 Jx16	8,60	30		

16078	R1-1598	BMW	3-er xDrive (E90)	7 Jx16	8,30	40	127,50
16079	R1-1594	Alfa Romeo	159/159 Sport Wagon	7 Jx16	8,40	30	107,80
			159/159 Sport Wagon	7 Jx16	8,40	30	
16081	R1-1610	Honda	Civic	6 1/2 Jx16	8,80	30	116,20
16082	R1-1612	Renault	Clio III	6 1/2 Jx16	7,60	0	106,90
16084	R1-1645	Ford	Galaxy II	6 1/2 Jx16	10,35	30	103,90
			S-Max	6 1/2 Jx16	10,35	30	
		Land Rover	Freelander II	6 1/2 Jx16	10,35	30	
16088	R1-1642	Volvo	S60/V60	7 Jx16	10,40	40	127,60
			S60/V60 Cross Country	7 Jx16	10,40	40	
			S80	7 Jx16	10,40	40	
			V70	7 Jx16	10,40	40	
			XC70	7 Jx16	10,40	40	
16089	R1-1663	Citroën	Berlingo II	6 1/2 Jx16	8,95	30	105,90
			C4 Picasso/Grand Picasso	6 1/2 Jx16	8,95	30	
		Peugeot	Partner II Tepee	6 1/2 Jx16	8,95	30	
16091	R1-1668	Toyota	Avensis II	6 1/2 Jx16	9,00	30	118,70
16092	R1-1652	Toyota	Corolla Verso	6 1/2 Jx16	8,85	30	120,20
16094	R1-1636	Citroën Nfz.	Jumper II	6 Jx16	12,00	30	130,00
			Fiat	Ducato II Kombi	6 Jx16	12,00	
		Fiat Nfz.	Ducato Maxi	6 Jx16	12,00	30	
			Ducato I (Facelift)	6 Jx16	12,00	30	
			Ducato II/Maxi	6 Jx16	12,00	30	
16095	R1-1647	Mercedes Nfz.	Sprinter II	6 1/2 Jx16	13,70	30	122,10
			Sprinter II	6 1/2 Jx16	13,70	30	
			Sprinter II (Facelift)	6 1/2 Jx16	13,70	30	
			Sprinter II (Facelift)	6 1/2 Jx16	13,70	30	
			Sprinter II 4x4 (Facelift)	6 1/2 Jx16	13,70	30	
		Volkswagen Nfz.	Crafter 30	6 1/2 Jx16	13,70	30	
			Crafter 30/35	6 1/2 Jx16	13,70	30	
16096	R1-1665	Fiat	Sedici	6 Jx16	13,70	30	115,10
		Suzuki	SX-4/SX4-Classic	6 Jx16	13,70	30	
16098	R1-1675	Citroën	Jumpy III Kombi	7 Jx16	13,70	30	118,40
		Citroën Nfz.	Jumpy III Kasten	7 Jx16	13,70	30	
		Fiat	Scudo II Kombi	7 Jx16	13,70	30	

16115	R1-1707	Ford	Kuga	6 1/2 Jx16	9,70	30	92,60
			Mondeo	6 1/2 Jx16	9,70	30	
			Mondeo (Mj.2015)	6 1/2 Jx16	9,70	30	
16116	R1-1701	Peugeot	308/SW/CC	7 Jx16	8,25	30	107,90
			3008	7 Jx16	8,25	30	
16117	R1-1723	Seat	Alhambra II	6 1/2 Jx16	8,25	30	105,70
		Volkswagen	Sharan II	6 1/2 Jx16	8,25	30	
			Tiguan	6 1/2 Jx16	8,25	30	
16119	R1-1710	Alfa Romeo	MiTo/Turismo	7 Jx16	8,60	30	116,90
16120	R1-1718	Saab	9-5	6 1/2 Jx16	8,40	30	102,10
16121	R1-1733	Citroën	C5/C5 Tourer	7 Jx16	8,00	24	116,20
16122	R1-1732	Renault	Fluence	6 1/2 Jx16	7,10	30	102,70
			Fluence Z.E.	6 1/2 Jx16	7,10	30	
			Megane III/Coupé/Grandtour	6 1/2 Jx16	7,10	30	
			Megane III Scenic/Grand Scenic/Xmod	6 1/2 Jx16	7,10	30	
16123	R1-1715	Fiat	Croma (Facelift)	6 1/2 Jx16	8,65	30	116,70
16124	R1-1722	Mazda	Mazda 6	6 Jx16	10,00	30	121,60
16125	R1-1737	Mitsubishi	Lancer/Sportback	6 1/2 JJx16	9,60	30	117,40
16126	R1-1725	Subaru	BRZ	6 1/2 JJx16	10,00	30	134,90
			Forester	6 1/2 JJx16	10,00	30	
			Impreza	6 1/2 JJx16	10,00	30	
			Legacy	6 1/2 JJx16	10,00	30	
			Legacy Outback	6 1/2 JJx16	10,00	30	
16127	R1-1731	Volkswagen	Caddy Life/Maxi	6 Jx16	8,00	30	102,40
			Caddy Generation Four/Beach	6 Jx16	8,00	30	
		Volkswagen Nfz.	Caddy/Maxi/Kombi	6 Jx16	8,00	30	
			Caddy/Maxi	6 Jx16	8,00	30	
16129	R1-1739	Honda	Accord/Tourer	6 1/2 Jx16	9,25	30	129,10
16130	R1-1748	Mazda	Mazda 5	6 1/2 Jx16	8,90	30	146,20
			MPV	6 1/2 Jx16	8,90	30	
			Tribute	6 1/2 Jx16	8,90	30	
16132	R1-1753	Citroën	C-Crosser	6 1/2 JJx16	9,40	30	129,80
		Mitsubishi	Outlander II	6 1/2 JJx16	9,40	30	
		Peugeot	4007	6 1/2 JJx16	9,40	30	
16133	R1-1754	Seat	Exeo/ST	7 Jx16	9,45	36	107,70

16148	R1-1799	Nissan Nfz.	NV400	5 1/2 Jx16	12,25	30	170,50	
		Opel Nfz.	Movano II	5 1/2 Jx16	12,25	30		
		Renault Nfz.	Master	5 1/2 Jx16	12,25	30		
16150	R1-1792	Chevrolet	Captiva	6 1/2 Jx16	10,95	30	150,90	
		Opel	Antara	6 1/2 Jx16	10,95	30		
16151	R1-1772	Alfa Romeo	Giulietta/Turismo	7 Jx16	9,20	30	119,60	
16152	R1-1781	Citroën	DS3/Cabrio	6 Jx16	7,05	30	99,90	
		Peugeot	208	6 Jx16	7,05	30		
16153	R1-1782	Peugeot	508/SW	7 Jx16	8,00	30	111,50	
16154	R1-1786	Fiat	Doblò	6 Jx16	9,40	30	101,10	
			Fiat Nfz.	Doblò Cargo/Maxi	6 Jx16	9,40		30
			Opel Nfz.	Combo-D	6 Jx16	9,40		30
16156	R1-1793	Mercedes	Viano	6 1/2 Jx16	11,35	30	146,40	
			Viano II (Facelift)	6 1/2 Jx16	11,35	30		
		Mercedes Nfz.	Vito II	6 1/2 Jx16	11,35	30		
			Vito II (Facelift)	6 1/2 Jx16	11,35	30		
			Vito E-CELL	6 1/2 Jx16	11,35	30		
16157	R1-1802	Mini	Mini Countryman (R60)	6 1/2 Jx16	8,30	30	110,70	
			Mini Paceman	6 1/2 Jx16	8,30	30		
16158	R1-1816	BMW	1-er (F20/21)	6 1/2 Jx16	7,75	40	88,20	
16161	R1-1812	Mercedes	A-Klasse	6 1/2 Jx16	8,40	30	95,60	
			B-Klasse	6 1/2 Jx16	8,40	30		
			CLA Klasse	6 1/2 Jx16	8,40	30		
16162	R1-1810	Volkswagen	Beetle/Cabrio	6 1/2 Jx16	8,20	30	110,80	
16163	R1-1808	Streetscooter	Work XL	6 1/2 Jx16	11,25	30	129,70	
		Volkswagen	T5 Multivan/California/Caravelle	6 1/2 Jx16	11,25	30		
			T6 Multivan/California/Caravelle	6 1/2 Jx16	11,25	30		
		Volkswagen Nfz.	Amarok	6 1/2 Jx16	11,25	30		
			T5 Transporter	6 1/2 Jx16	11,25	30		
		T6/T6.1 Transporter	6 1/2 Jx16	11,25	30			
16165	R1-1818	Mazda	Mazda 5	6 1/2 Jx16	10,60	30	119,70	
16166	R1-1822	Mitsubishi	ASX	6 1/2 Jx16	8,95	30	129,70	
16167	R1-1821	Kia	Sportage III	6 1/2 Jx16	9,40	30	123,90	
			Sportage III	6 1/2 Jx16	9,40	30		
16168	R1-1673	Mercedes Nfz.	Sprinter II	5 1/2 Jx16	10,50	30	119,20	
		Volkswagen Nfz.	Crafter 30	5 1/2 Jx16	10,50	30		

MWD-Nr.	MW-AM Nr.	Fahrzeughersteller	Modellbezeichnung	Radabmessung	Gewicht pro Rad	Stk. pro Pal.	Preis in € ohne MwSt.
MWD-Ref.	MW-AM Ref.	Car producer	Car model	Wheel size	Weight p. wheel	Qty. p. Pal.	Price in € without TVA

MWD-Nr.	MW-AM Nr.	Fahrzeughersteller	Modellbezeichnung	Radabmessung	Gewicht pro Rad	Stk. pro Pal.	Preis in € ohne MwSt.
MWD-Ref.	MW-AM Ref.	Car producer	Car model	Wheel size	Weight p. wheel	Qty. p. Pal.	Price in € without TVA

MWD-Nr.	MW-AM Nr.	Fahrzeughersteller	Modellbezeichnung	Radabmessung	Gewicht pro Rad	Stk. pro Pal.	Preis in € ohne MwSt.
MWD-Ref.	MW-AM Ref.	Car producer	Car model	Wheel size	Weight p. wheel	Qty. p. Pal.	Price in € without TVA

Radnummern aufsteigend

16169	R1-1825	Hyundai	i40/i40cw/i40Space	7 Jx16	9,90	24	123,90
16171	R1-1834	Nissan	Juke	6 1/2 Jx16	8,75	30	118,80
16172	R1-1835	Fiat	500L/Living/Trekking	6 Jx16	7,75	30	101,90
16173	R1-1849	Audi	A6/Avant	7 1/2 Jx16	7,75	30	108,60
16175	R1-1857	Honda	Civic	6 1/2 Jx16	9,65	30	120,70
16176	R1-1853	Hyundai	i30/i30cw	6 1/2 Jx16	9,30	30	107,70
		Kia	Cee'd/Pro Cee'd/Sporty Wagon	6 1/2 Jx16	9,30	30	
16177	R1-1851	Audi	A3/Sportback	6 Jx16	7,90	30	95,10
		Seat	Leon III	6 Jx16	7,90	30	
		Skoda	Octavia III	6 Jx16	7,90	30	
		Volkswagen	Golf VII	6 Jx16	7,90	30	
			Golf VII Variant/Sportsvan	6 Jx16	7,90	30	
16178	R1-1852	Audi	A3/Sportback	6 1/2 Jx16	7,75	30	95,40
		Seat	Leon III	6 1/2 Jx16	7,75	30	
		Skoda	Octavia III	6 1/2 Jx16	7,75	30	
		Volkswagen	Golf VII	6 1/2 Jx16	7,75	30	
			Golf VII Variant/Sportsvan	6 1/2 Jx16	7,75	30	
16180	R1-1859	Mercedes Nfz.	Sprinter II (Facelift)	5 1/2 Jx16	11,95	30	175,00
			Sprinter II 4x4 (Facelift)	5 1/2 Jx16	11,95	30	
			Sprinter III RWD (W907)	5 1/2 Jx16	11,95	30	
			Sprinter III 4x4 (W907)	5 1/2 Jx16	11,95	30	
		Volkswagen Nfz.	Crafter 35/50	5 1/2 Jx16	11,95	30	
16181	R1-1866	Chevrolet	Trax	6 1/2 Jx16	8,40	30	104,20
		Opel	Mokka	6 1/2 Jx16	8,40	30	
			Mokka-X	6 1/2 Jx16	8,40	30	
16183	R1-1864	Ford	Tourneo Custom	6 1/2 Jx16	9,50	30	124,40
		Ford Nfz.	Transit/Transit Custom	6 1/2 Jx16	9,50	30	
16184	R1-1862	Toyota	Auris II/Touring Sport	6 1/2 Jx16	9,45	30	108,40
			Corolla	6 1/2 Jx16	9,45	30	
			Yaris IV Cross	6 1/2 Jx16	9,45	30	
16185	R1-1878	Suzuki	SX-4 S-Cross	6 Jx16	7,45	30	112,10

16201	R1-1897	Renault	Kadjar/Kadjar XMOD	6 1/2 Jx16	8,40	30	106,90
16202	R1-1896	Fiat	Talento	6 Jx16	10,80	30	111,90
16202	R1-1896	Fiat Nfz.	Talento	6 Jx16	10,80	30	
		Nissan Nfz.	NV300	6 Jx16	10,80	30	
		Opel Nfz.	Vivaro III	6 Jx16	10,80	30	
		Renault Nfz.	Trafic III	6 Jx16	10,80	30	
16204	R1-1907	Fiat	500L/Living/Trekking	6 Jx16	8,40	30	102,90
16205	R1-1940	Ford	EcoSport	6 Jx16	8,50	30	97,20
16207	R1-1911	Mercedes	V-Klasse/Marco Polo (W447)	6 1/2 Jx16	9,70	30	128,10
		Mercedes Nfz.	Vito III/Tourer/Kasten/Mixto	6 1/2 Jx16	9,70	30	
16208	R1-1909	Citroën	Jumper III Kombi	6 Jx16	11,75	25	141,60
		Citroën Nfz.	Jumper III	6 Jx16	11,75	25	
		Fiat	Ducato III Kombi	6 Jx16	11,75	25	
		Peugeot	Boxer III Kombi	6 Jx16	11,75	25	
		Peugeot Nfz.	Boxer III	6 Jx16	11,75	25	
16209	R1-1910	Citroën	Jumper II Kombi	6 Jx16	13,10	30	133,90
		Citroën Nfz.	Jumper II	6 Jx16	13,10	30	
			Jumper II (Facelift)	6 Jx16	13,10	30	
			Jumper III/e-Jumper	6 Jx16	13,10	30	
		Fiat	Ducato II Kombi	6 Jx16	13,10	30	
		Fiat Nfz.	Ducato II Maxi	6 Jx16	13,10	30	
			Ducato II/Maxi (Facelift)	6 Jx16	13,10	30	
			Ducato III/Maxi	6 Jx16	13,10	30	
		Opel Nfz.	Movano III Cargo/Movano-e Cargo	6 Jx16	13,10	30	
		Peugeot	Boxer II Kombi	6 Jx16	13,10	30	
		Peugeot Nfz.	Boxer II	6 Jx16	13,10	30	
			Boxer II (Facelift)	6 Jx16	13,10	30	
			Boxer III	6 Jx16	13,10	30	
16210	R1-1926	Hyundai	ix35 (Facelift)	6 1/2 Jx16	10,35	30	112,30
16211	R1-1916	BMW	1-er (F40)	7 Jx16	8,50	30	110,50
			2-er Active Tourer (F45)	7 Jx16	8,50	30	

16237	R1-1980	Opel	Zafira Life S/M/L/Zafira Life-e	7 Jx16	10,20	30	105,40
		Opel Nfz.	Vivaro IV Cargo/Vivaro-e Cargo	7 Jx16	10,20	30	
		Peugeot	Expert Traveller/e-Traveller	7 Jx16	10,20	30	
		Peugeot Nfz.	Expert III/e-Expert III	7 Jx16	10,20	30	
		Toyota	ProAce Verso	7 Jx16	10,20	30	
		Toyota Nfz.	ProAce/Pro Ace Electric	7 Jx16	10,20	30	
16238	R1-1962	Jeep	Renegade	6 1/2 Jx16	11,55	30	127,50
16243	R1-1969	Hyundai	ix35	6 1/2 Jx16	10,27	30	117,30
			Tucson	6 1/2 Jx16	10,27	30	
		Kia	Niro	6 1/2 Jx16	8,70	30	
16244	R1-1970	Hyundai	Sonata/Sonica	6 1/2 Jx16	10,27	30	139,60
			Tucson	6 1/2 Jx16	10,27	30	
		Kia	Magentis	6 1/2 Jx16	10,27	30	
			Sportage II	6 1/2 Jx16	10,27	30	
16245	R1-1997	Nissan	Micra IV	6 Jx16	7,92	30	111,50
16246	R1-2009	Ford	Fiesta VII	6 1/2 Jx16	0,00	30	96,70
16247	R1-2011	Hyundai	i30/Fastback/Kombi	6 1/2 Jx16	8,54	30	107,90
		Kia	Cee'd/Sporty Wagon	6 1/2 Jx16	8,54	30	
16249	R1-2015	MAN Nfz.	TGE 3.5/5.0	5 1/2 Jx16	11,95	30	190,10
		Volkswagen Nfz.	Crafter II 35/50	5 1/2 Jx16	11,95	30	
16250	R1-2016	MAN Nfz.	TGE 3.0/3.5/E-TGE	6 1/2 Jx16	11,76	30	120,30
		Volkswagen Nfz.	Crafter II 30/35/E-Crafter	6 1/2 Jx16	11,76	30	
16251	R1-2035	Honda	Civic	7 Jx16	10,42	30	120,90
16252	R1-2034	Seat	Arona	6 Jx16	7,40	30	98,80
			Ibiza	6 Jx16	7,40	30	
16253	R1-2038	Ford	EcoSport (Facelift)	6 1/2 Jx16	8,70	30	104,70
16254	R1-2033	Mercedes Nfz.	Sprinter II (W906)	8 1/2 Jx16	17,05	24	248,10
16255	R1-2039	Hyundai	Kona	6 1/2 Jx16	8,50	30	116,40
16256	R1-2041	Peugeot	508/SW II	7 Jx16	7,85	30	105,20
16265	R1-2051	Mercedes Nfz.	Sprinter III RWD (W907)	6 1/2 Jx16	11,13	36	121,90
			Sprinter III 4x4 (W907)	6 1/2 Jx16	11,13	36	

16186	R1-1886	Ford	Kuga II	6 1/2 Jx16	10,00	30	104,90
			Tourneo Connect/ Grand Tourneo Connect	6 1/2 Jx16	10,00	30	
		Ford Nfz.	Transit Connect	6 1/2 Jx16	10,00	30	
16187	R1-1884	Kia	Carens III	6 1/2 Jx16	9,50	30	123,90
16188	R1-1883	Mazda	CX-3	6 1/2 Jx16	10,30	30	119,80
			Mazda 3	6 1/2 Jx16	10,30	30	
16189	R1-1890	Citroën	C3 III	6 1/2 Jx16	10,30	30	97,90
			C3 Aircross	6 1/2 Jx16	10,30	30	
			C4 Cactus	6 1/2 Jx16	10,30	30	
		Opel	Crossland-X	6 1/2 Jx16	10,30	30	
		Peugeot	2008	6 1/2 Jx16	10,30	30	
16190	R1-1887	Citroën	Berlingo III M/XL	6 1/2 Jx16	7,90	30	108,30
			C4 Picasso/Grand Picasso	6 1/2 Jx16	7,90	30	
			C4 Spacetourer/Grand Spacetourer	6 1/2 Jx16	7,90	30	
		Opel	Combo Life	6 1/2 Jx16	7,90	30	
		Peugeot	Rifter L1/L2	6 1/2 Jx16	7,90	30	
		Toyota	ProAce City Verso	6 1/2 Jx16	7,90	30	
16191	R1-1882	Opel	Grandland X	7 Jx16	7,80	30	105,10
			Astra/Astra Sports Tourer	7 Jx16	7,80	30	
		Peugeot	308/SW	7 Jx16	7,80	30	
			308 III	7 Jx16	7,80	30	
16193	R1-1892	Renault	Captur	6 1/2 Jx16	7,60	30	96,00
16194	R1-1871	Audi	A3 Limousine/Cabrio	6 1/2 Jx16	7,60	30	105,90
			A3/A3 Sportback	6 1/2 Jx16	7,60	30	
16195	R1-1872	Audi	A3/Sportback	7 Jx16	7,70	30	97,40
16196	R1-1800	Audi	A4/Avant	7 1/2 Jx16	9,15	30	116,90
16198	R1-1906	BMW	1-er (F20/Z1)	7 Jx16	7,95	30	113,20
			2-er Coupé/Cabrio (F22/F23))	7 Jx16	7,95	30	
16199	R1-1904	BMW	1-er (F20/Z1)	6 1/2 Jx16	7,10	40	112,60
16200	R1-1809	Volkswagen Nfz.	T5 BlueMotion	6 1/2 Jx16	11,25	30	106,20
16201	R1-1897	Nissan	Juke	6 1/2 JJx16	8,40	30	106,90
			Leaf	6 1/2 JJx16	8,40	30	
			Leaf II	6 1/2 JJx16	8,40	30	
			Pulsar	6 1/2 JJx16	8,40	30	
			Qashqai II	6 1/2 JJx16	8,40	30	

16213	R1-1918	Fiat	500X	6 1/2 Jx16	9,80	30	105,40
			Jeep	Compass	6 1/2 Jx16	9,80	
			Renegade	6 1/2 Jx16	9,80	30	
16214	R1-1913	Iveco Nfz.	Iveco Daily/DailyE6/ DailyE6-Hi-Matic	6 1/2 Jx16	12,15	30	152,30
16215	R1-1924	Ford Nfz.	Transit	6 Jx16	14,65	30	145,60
16216	R1-1927	Kia	Soul II	6 1/2 Jx16	10,00	30	117,70
16217	R1-1928	Kia	Sportage III (Facelift)	6 1/2 Jx16	9,10	30	117,30
16218	R1-1919	Mercedes	C-Klasse (W205)	6 Jx16	8,90	30	92,20
16219	R1-1921	Skoda	Superb III/Combi	6 1/2 Jx16	8,05	30	99,90
		Volkswagen	Passat/Variant (Mj.2015)	6 1/2 Jx16	8,05	30	
16220	R1-1943	Toyota	Prius III	6 Jx16	9,10	36	122,50
16222	R1-1956	Renault	Megane IV/Grandtour	6 1/2 Jx16	6,70	30	105,90
			Talisman/Grandtour	6 1/2 Jx16	6,70	30	
16223	R1-1947	Suzuki	SX-4 S-Cross	6 1/2 Jx16	7,75	30	113,70
			Vitara	6 1/2 Jx16	7,75	30	
16224	R1-1958	Volkswagen	Touran II	6 1/2 Jx16	9,30	30	106,90
16225	R1-1953	Opel	Astra-K/Sports Tourer	6 1/2 Jx16	8,40	30	98,60
16226	R1-1950	Hyundai Nfz.	H350	6 1/2 Jx16	12,70	30	147,20
16228	R1-1964	Fiat	Tipo	6 1/2 Jx16	8,45	30	103,30
16229	R1-1965	Nissan Nfz.	Navara/NP300	6 Jx16	10,95	30	111,60
16230	R1-1966	Nissan Nfz.	Navara/NP300	7 Jx16	11,80	30	144,10
16233	R1-1973	Ford	Ranger	7 Jx16	15,50	30	134,90
			Ford Nfz.	Ranger/Ranger 4x4	7 Jx16	15,50	
16234	R1-1976	Toyota	Hilux	6 Jx16	11,95	30	141,10
16235	R1-1978	Kia	Sportage IV	6 1/2 Jx16	10,40	30	108,10
16236	R1-1979	Audi	Q2	6 Jx16	7,95	30	97,90
			Seat	Ateca	6 Jx16	7,95	
		Skoda	Karoq	6 Jx16	7,95	30	
		Volkswagen	T-Roc/Cabrio	6 Jx16	7,95	30	
16237	R1-1980	Citroën	Jumpy IV Spacetourer/ e-Spacetourer	7 Jx16	10,20	30	105,40
			Citroën Nfz.	Jumpy IV/e-Jumpy IV	7 Jx16	10,20	
		Fiat	Ulysse-E	7 Jx16	10,20	30	
		Fiat Nfz.	Scudo III/E-Scudo	7 Jx16	10,20	30	
		Opel	Vivaro Life/Vivaro Life-e	7 Jx16	10,20	30	

16266	R1-2047	Ford	Tourneo Connect/ Grand Tourneo Connect (Facelift)	6 1/2 Jx16	9,30	30	116,00
			Ford Nfz.	Transit Connect (Facelift)	6 1/2 Jx16	9,30	
16268	R1-2050	Mercedes Nfz.	Sprinter III FWD (W910)	6 1/2 Jx16	11,25	36	118,50
		Volkswagen Nfz.	Crafter 30	6 1/2 Jx16	11,25	36	
			Crafter 30/35	6 1/2 Jx16	11,25	36	
16269	R1-2052	Subaru	Impreza	6 1/2 Jx16	8,50	30	125,20
16270	R1-2048	Mercedes	A-Klasse/Limousine (W177)	6 1/2 Jx16	8,30	30	111,20
			B-Klasse (W247)	6 1/2 Jx16	8,30	30	
			CLA-Klasse (W118)	6 1/2 Jx16	8,30	30	
16271	R1-2053	MAN Nfz.	TGE 3.5/E-TGE	6 1/2 Jx16	12,16	30	135,90
		Volkswagen Nfz.	Crafter II 35/E-Crafter	6 1/2 Jx16	12,16	30	
16273	R1-2059	Citroën	C4/e-C4	6 1/2 Jx16	7,70	30	104,20
			DS3 Crossback	6 1/2 Jx16	7,70	30	
		Opel	Corsa-F Elektro	6 1/2 Jx16	7,70	30	
			Mokka/e-Mokka	6 1/2 Jx16	7,70	30	
		Peugeot	208 II GT-Line/e-208	6 1/2 Jx16	7,70	30	
			2008 II/e-2008	6 1/2 Jx16	7,70	30	
16274	R1-2061	Opel	Corsa-F	6 1/2 Jx16	7,70	30	96,80
		Peugeot	208 II/e-208	6 1/2 Jx16	7,70	30	
16275	R1-2088	Seat	Leon IV/Sportstourer	6 1/2 Jx16	7,55	30	96,10
		Skoda	Octavia IV	6 1/2 Jx16	7,55	30	
		Volkswagen	Golf VIII/Variant	6 1/2 Jx16	7,55	30	
16277	R1-2066	Skoda	Kamiiq	6 Jx16	7,40	36	99,90
			Scala	6 Jx16	7,40	36	
		Volkswagen	Taigo	6 Jx16	7,40	36	
			T-Cross	6 Jx16	7,40	36	
16278	R1-2020	Citroën	C3 III	6 1/2 Jx16	10,30	30	99,90
			C3 Aircross	6 1/2 Jx16	10,30	30	
			C4 Cactus	6 1/2 Jx16	10,30	30	
		DS3/Cabrio	6 1/2 Jx16	10,30	30		
		Opel	Crossland-X	6 1/2 Jx16	10,30	30	
Peugeot	208	6 1/2 Jx16	10,30	30			
	2008	6 1/2 Jx16	10,30	30			
16279	R1-2080	Mazda	CX-30	6 1/2 Jx16	10,00	30	119,80
			Mazda 3	6 1/2 Jx16	10,00	30	

MWD-Nr.	MW-AM Nr.	Fahrzeughersteller	Modellbezeichnung	Radabmessung	Gewicht pro Rad	Stk. pro Pal.	Preis in € ohne MwSt.
MWD-Ref.	MW-AM Ref.	Car producer	Car model	Wheel size	Weight p. wheel	Qty. p. Pal.	Price in € without TVA

MWD-Nr.	MW-AM Nr.	Fahrzeughersteller	Modellbezeichnung	Radabmessung	Gewicht pro Rad	Stk. pro Pal.	Preis in € ohne MwSt.
MWD-Ref.	MW-AM Ref.	Car producer	Car model	Wheel size	Weight p. wheel	Qty. p. Pal.	Price in € without TVA

MWD-Nr.	MW-AM Nr.	Fahrzeughersteller	Modellbezeichnung	Radabmessung	Gewicht pro Rad	Stk. pro Pal.	Preis in € ohne MwSt.
MWD-Ref.	MW-AM Ref.	Car producer	Car model	Wheel size	Weight p. wheel	Qty. p. Pal.	Price in € without TVA

Radnummern aufsteigend

16280	R1-2067	Skoda	Kamiq	6 Jx16	7,50	42	94,90	
			Scala	6 Jx16	7,50	42		
16282	R1-2075	Renault	Clio V	6 1/2 Jx16	8,95	30	105,70	
16283	R1-2078	Suzuki	Swace	7 Jx16		30	115,50	
			Toyota	Corolla/Limousine/Touring Sport	7 Jx16			30
16284	R1-2076	Mitsubishi	ASX	6 1/2 Jx16	8,65	30	100,80	
			Nissan	Juke	6 1/2 Jx16	8,65		30
			Renault	Captur II	6 1/2 Jx16	8,65		30
16285	R1-2044	Iveco Nfz.	Iveco Daily/DailyE6/DailyE6-Hi-Matic	5 1/2 Jx16	13,10	30	138,60	
16286	R1-2083	Ford	Puma	6 1/2 Jx16	7,55	30	102,60	
16287	R1-2090	Ford	Tourneo Connect	6 1/2 Jx16	8,85	36	110,70	
			Ford Nfz.	Transit Connect	6 1/2 Jx16	8,85		36
			Volkswagen	Caddy	6 1/2 Jx16	8,85		36
			Volkswagen Nfz.	Caddy Cargo	6 1/2 Jx16	8,85		36
16288	R1-2092	Volkswagen	Caddy	6 1/2 Jx16	8,00	36	106,90	
16288	R1-2092	Volkswagen Nfz.	Caddy Cargo	6 1/2 Jx16	8,00	36	106,90	
16289	R1-2094	Citroën	e-Berlingo III	6 1/2 Jx16	7,90	30	108,30	
			Citroën Nfz.	Berlingo III M/XL	6 1/2 Jx16	7,90		30
			Fiat Nfz.	Doblò Cargo/E-Doblò (Mj. 2022)	6 1/2 Jx16	7,90		30
			Opel	Combo-e Life	6 1/2 Jx16	7,90		30
			Opel Nfz.	Combo Cargo/Cargo XL/Combo-e Cargo	6 1/2 Jx16	7,90		30
			Peugeot	e-Rifter L1/L2	6 1/2 Jx16	7,90		30
			Peugeot Nfz.	Partner III/Rifter/L1/L2	6 1/2 Jx16	7,90		30
			Toyota Nfz.	ProAce City	6 1/2 Jx16	7,90		30
16290	R1-2095	Kia	XCeed	6 1/2 Jx16	8,65	30	102,90	
16291	R1-2102	Dacia	Jogger	6 1/2 Jx16	8,35	30	109,60	
16292	R1-2105	Iveco Nfz.	Iveco Daily/DailyE6/DailyE6-Hi-Matic	6 Jx16	16,90	36	146,10	
16293	R1-2112	Mercedes	T-Klasse	6 Jx16	8,65	30	109,60	

17008	R1-1778	Peugeot	3008	7 1/2 Jx17	9,65	25	131,90	
17010	R1-1861	Toyota	RAV4	6 1/2 Jx17	10,00	25	145,30	
17011	R1-1885	Honda	CR-V	6 1/2 Jx17	10,00	25	151,40	
17012	R1-1912	Mercedes	V-Klasse/Marco Polo (W447)	6 1/2 Jx17	10,60	25	149,20	
			Mercedes Nfz.	Vito III/Tourer/Kasten/Mixto/e-Vito	6 1/2 Jx17	10,60		25
17013	R1-1920	Mercedes	GLA	6 1/2 Jx17	9,40	25	129,80	
17014	R1-1932	Opel	Astra-J GTC	7 Jx17	10,00	25	133,70	
			Cascada	7 Jx17	10,00	25		
17016	R1-1944	Jeep	Renegade	6 1/2 Jx17	11,10	25	105,90	
17018	R1-1948	Ford	Galaxy III	7 1/2 Jx17	12,90	20	127,10	
			S-Max II	7 1/2 Jx17	12,90	20		
17019	R1-1946	Nissan	Qashqai III	7 Jx17	8,55	20	132,80	
			Renault	Austral E-Tech	7 Jx17	8,55		20
			Espace	7 Jx17	8,55	20		
17020	R1-1974	Ford	Ranger	7 1/2 Jx17	13,45	25	148,60	
17021	R1-1981	Audi	Q3 II/Sportback/e-tron	6 1/2 Jx17	10,80	25	110,90	
			Seat	Tarraco	6 1/2 Jx17	10,80		25
			Skoda	Kodiaq	6 1/2 Jx17	10,80		25
		Volkswagen	Tiguan II/Tiguan Allspace	6 1/2 Jx17	10,80	25		
17022	R1-1982	Toyota	C-HR	6 1/2 Jx17	11,02	25	135,90	
17023	R1-1983	Ford	Kuga II	7 1/2 Jx17	10,35	25	115,40	
17024	R1-2017	Kia	Sportage IV	7 Jx17	11,90	25	141,50	
17025	R1-1996	Citroën	C5 Aircross	7 Jx17	9,20	25	115,90	
			Citroën	DS4	7 Jx17	9,20		25
			Opel	Grandland-X/Grandland	7 Jx17	9,20		25
			Peugeot	3008 II	7 Jx17	9,20		25
				5008 II	7 Jx17	9,30		25
17026	R1-2036	Kia	e-Soul	7 Jx17	11,00	25	129,90	
			Mazda	CX-5 II	7 Jx17	11,00		25
17027	R1-2037	Mercedes Nfz.	X-Klasse	7 1/2 Jx17	14,80	25	160,90	
17029	R1-2040	Citroën	DS7 Crossback	7 Jx17	9,10	25	116,40	

17041	R1-2091	Ford	Tourneo Connect	6 1/2 Jx17	10,10	30	116,20	
			Ford Nfz.	Transit Connect	6 1/2 Jx17	10,10		30
			Volkswagen	Caddy	6 1/2 Jx17	10,10		30
			Volkswagen Nfz.	Caddy Cargo	6 1/2 Jx17	10,10		30
17042	R1-2093	Mercedes Nfz.	Sprinter III (W907)	7 Jx17	11,90	30	148,90	
17045	R1-2111	Hyundai	Tucson	7 Jx17		25	131,80	
			Kia	Sportage V	7 Jx17			25
17046	R1-2123	Toyota	Aygo X	5 Jx17		25	131,00	
17047	R1-2130	Hyundai	Staria	6 1/2 Jx17		25	142,50	
17048	R1-2129	Ford	Kuga III	7 Jx17		25	116,40	
18004	R1-2089	Volkswagen	ID.3	7 1/2 Jx18	11,60	20	149,20	
18005	R1-2108	Skoda	Enyaq iV	8 Jx18	13,35	25	142,80	
			Volkswagen	ID.4	8 Jx18	13,35		25
				ID.Buzz/ID.Buzz Cargo	8 Jx18	13,35		25
18006	R1-2131	Volkswagen	ID.Buzz/ID.Buzz Cargo	8 1/2 Jx18	13,75	16		
18007		Citroën	e-C4 X	6 1/2 Jx18		16		
19004	R1-2109	Audi	Q4 e-tron/Q4 e-tron Sportback	8 Jx19	14,45	16	154,10	
			Skoda	Enyaq iV	8 Jx19	14,45		20
			Volkswagen	ID.4	8 Jx19	14,45		16
				ID.5	8 Jx19	14,45		16
20001	R1-1984	Renault	Scenic/Grand-Scenic	6 1/2 Jx20	11,65	20	175,50	

16293	R1-2112	Mercedes Nfz.	Citan II/Citan II Tourer	6 Jx16	8,65	30	109,60
		Nissan Nfz.	Townstar	6 Jx16	8,65	30	
		Renault	Kangoo III	6 Jx16	8,65	30	
		Renault Nfz.	Kangoo III Rapid	6 Jx16	8,65	30	
16294	R1-2110	Iveco Nfz.	Iveco Daily HEV	6 1/2 Jx16		30	143,90
16295	R1-2114	Volkswagen	T7	6 1/2 Jx16	11,15	30	123,90
16295	R1-2114	Volkswagen Nfz.	T7	6 1/2 Jx16	11,15	30	123,90
16300		Citroën	C3	6 1/2 Jx16		30	info
16302		Mitsubishi	Colt	6 1/2 Jx16		30	info
16303	R1-2132	Skoda	Superb IV	7 Jx16		30	info
17001	R1-1409	BMW	3-er Compact (E46)	7 Jx17	10,15	20	147,20
			3-er Lim/Touring (E46)	7 Jx17	10,15	20	
			3-er Lim/Touring/4x4 (E46)	7 Jx17	10,15	20	
			3-er Coupé/Cabrio (E46)	7 Jx17	10,15	20	
17002	R1-1614	Volkswagen	T5 Multivan/California/Caravelle	7 Jx17	14,00	25	169,70
			T6 Multivan/California/Caravelle	7 Jx17	14,00	25	
		Volkswagen Nfz.	T5 Transporter	7 Jx17	14,00	25	
			T6/T6.1 Transporter	7 Jx17	14,00	25	
17003	R1-1429	Renault	Espace/Grand Espace	7 Jx17	10,20	25	145,90
			Vel Satis	7 Jx17	10,20	25	
17007	R1-1759	BMW	X1 (E84)	7 1/2 Jx17	10,60	25	138,50

17035	R1-2046	Citroën	Campster/Vanster	7 Jx17	11,05	25	136,20
			Jumpy IV Spacetourer/ e-Spacetourer	7 Jx17	11,05	25	
		Citroën Nfz.	Jumpy IV/e-Jumpy IV	7 Jx17	11,05	25	
		Fiat	Ulysse-E	7 Jx17	11,05	25	
		Fiat Nfz.	Scudo III/E-Scudo	7 Jx17	11,05	25	
		Opel	Vivaro Life/Vivaro Life-e	7 Jx17	11,05	25	
			Zafira Life S/M/L/Zafira Life-e	7 Jx17	11,05	25	
		Opel Nfz.	Vivaro IV Cargo/Vivaro-e Cargo	7 Jx17	11,05	25	
		Peugeot	Expert Traveller/e-Traveller	7 Jx17	11,05	25	
			Traveller Crosscamp	7 Jx17	11,05	25	
		Peugeot Nfz.	Expert III/e-Expert III	7 Jx17	11,05	25	
		Toyota	Crosscamp	7 Jx17	11,05	25	
			ProAce Verso	7 Jx17	11,05	25	
Toyota Nfz.	ProAce	7 Jx17	11,05	25			
17036	R1-2049	Mercedes	A-Klasse/Limousine (W177)	6 1/2 Jx17	10,48	25	121,10
			B-Klasse (W247)	6 1/2 Jx17	10,48	25	
			CLA-Klasse (W118)	6 1/2 Jx17	10,48	25	
17038	R1-2079	Toyota	RAV4	7 Jx17		25	142,10
17040	R1-2086	Mercedes	GLA II	7 Jx17		25	133,40
			GLB	7 Jx17		25	



PKW STAHLSCHEIBENRÄDER
2023/2024

Trailer Räder



13126

13133

13137

14213

15280

MWD No.	MW-No.	Radabmessung	Lochzahl	Lochkreis	Mittelloch	ET	Traglast	Farbe	Stck/Pal.	Gewicht	Bolzenlochauf.	Preis in €
MWD No.	MW-No.	Rim size	Hole number	PCD	Center Hole	Offset	load	colour	pcs/pal.	weight	Fixing type	Price in €
12012	R1-2126	5 1/2 J x 12	5	112	67	30		silver				info
13126	R1-1440	4.00 B x 13 FH	4	100	57	30	500	silver	135	5,39		62,00 €
13127	R1-1428	4 1/2 J x 13 FH	4	100	57	30	600	silver	135	6,2		65,40 €
13132	R1-1427	5 J x 13 H2	5	112	66,5	33	725	silver	135	6,49	(spherical)	67,70 €
13133	R1-1585	4 1/2 J x 13 H2	5	112	66,5	30	710	silver	135	6,03	(spherical)	64,40 €
13136	R1-2117	4 J x 13	4	100	57	30	500	silver				info
13137	R1-2116	6 J x 13 H2	5	112	66,5	30	900	silver	108	7,45	(spherical)	80,00 €
14213	R1-1423	5 1/2 J x 14 H2	5	112	66,5	30	900	silver	108	7,95	(spherical)	76,70 €
14217	R1-2127	5 1/2 J x 14	5	112	66,5	30	950	silver	108			imfo
15280	R1-1556	5 1/2 J x 15 H2	5	112	66,5	30	950	silver	40	8,25		82,70 €





LKW

STAHLSCHEIBENRÄDER

2023/2024



Steilschulter-Räder für Tieflader



AC14017* AC14018* A15753* A15849* A15852* A15853* A15854* A15855*

Felgenreöße	Radausführung (EUWA)	Mittenloch mm	Bolzenlochkreis mm	Bolzenlochzahl	Einpresstiefe mm	Halber Mittenabstand mm	Versandgewicht kg	Rad-Nr.	Radlast kg	Anwendung	Stück/Pal.	Ventilausführung	Reifengröße (empfohlen)
rim size	fixing type (EUWA)	hub diameter mm	bolt hole diameter mm	no. of bolt holes	offset mm	half dual spacing mm	weight kg	MWD art. no.	max. payload kg	customer	Qty. /pal.	valve type	tyre dimension (recommended)
17,5 x 6,00	M20(Ø24)	176	225	10	123	134	22	A15853*	2.430		20	V3-22-1	205/75R17,5 215/75R17,5 225/75R17,5 8-8,5-9-9,5R17,5
	M22(Ø26)	176	225	10	123	134	22	A15849*	2.430		20	V3-22-1	
	M22DS36	176	225	10	123	134	22	A15852*	2.430		20	V3-22-1	
17,5 x 6,75	M22(Ø26)	176	225	10	129	140	25	AC14018*	3.150		20	V3-20-4	9,5-10R17,5 225/75R17,5 245/70R17,5 265/70R17,5
	M22IS36	176	225	10	130	140	25	AC14017*	3.150		20	V3-20-4	
19,5 x 7,50	M22DS36	176	225	10	139	150	28,5	A15753*	2.725		12	V3-22-1	245/70R19,5 265/70 R 19,5 285/70 R 19,5
	M22(Ø24)	176	225	10	139	150	28,5	A15854*	2.725		12	V3-22-1	
	M22(Ø26)	176	225	10	139	150	28,5	A15855*	2.725		12	V3-22-1	

*= mit außenliegendem Ventilloch

Steilschulter-Räder für LKW und Anhänger (einteilig)



AC14000*

AC14008*

AC15107*

AC15121*

AC15145*

AC15146*

AC35037*

AC35367*

AC35369*



AC35370*

AC35425*

AC36322*

AC36403*

A15370*

A15488*

A15516*

A15536*

A15925*



A16005*

A16016*

A16017*

A16090*

A16094*

A16099*

A16104*

A16135*

A16187*



A16133*

2920839

117599*

117767*

Felgenreiße	Radausföhrung (EUWA)	Mittenloch mm	Bolzenlochkreis mm	Bolzenlochzahl	Einpresstiefe mm	Halber Mittenabstand mm	Versandgewicht kg	Rad-Nr.	Radlast kg	Anwendung	Stück/Pal.	Ventilausföhrung	ReifengröÙe (empfohlen)
rim size	fixing type (EUWA)	hub diameter mm	bolt hole diameter mm	no. of bolt holes	offset mm	half dual spacing mm	weight kg	MWD art. no.	max. payload kg	customer	Qty. /pal.	valve type	tyre dimension (recommended)
17,5 x 6,00	M18(Ø21)	202	245	6	120	131	20,5	AC14008*	1.850	MAN, div.	20	V3-22-1	205/75R17,5 215/75R17,5 225/75R17,5 8-8,5-9-9,5R17,5
	M20(Ø24)	221	275	8	124	134	20,5	A15516*	1.850	Iveco	20	V3-22-1	
	M18(Ø21)	161	205	6	120	131	20,5	AC14000*	1.850	Nissan/Iveco	20	V3-22-1	
	M18(Ø21)	191	245	6	120	131	21,5	A16005*	1.850	Nissan/Iveco	20	V3-22-1	
17,5 x 6,75	M18(Ø21)	202	245	6	128	139	20	AC35037*	2.240	Anhänger	20	V3-22-1	225/75R17,5 245/75R17,5 265/75R17,5 9,5-10R17,6
	M18(DS36)	202	245	6	128	139	20	AC36322*	2.000	MB	20	V3-22-1	
	M18(Ø21)	202	245	6	128	139	24	A16016*	2.360	MB	20	V3-22-1	
19,5 x 6,75	M20(Ø24)	221	275	8	131	144	27,5	A15370*	2.360	MAN/Iveco	16	V3-22-1	245/70R19,5 265/70R19,5 9,5R19,5
	M22DS36	221	275	8	133	145	23,8	AC35367*	2.500	MB	16	V3-22-1	
19,5 x 7,50	M20(Ø24)	221	275	8	144	156	25,8	AC35369*	3.000	MAN/Iveco	12	V3-22-1	245/70R19,5 265/70R19,5 285/70R19,5
	M22DS36	221	275	8	144	156	25,8	AC35370*	3.000	MB	12	V3-22-1	
19,5 x 8,25	B22DS36	221	275	8	154	167	29	A15488*	3.150	MB	12	V3-22-1	265/70R19,5
	M20(Ø24)	221	275	8	154	167	29	A16017*	3.150	MB	12	V3-22-1	285/70R19,5
19,5 x 14,00	M22(Ø26)	281	335	10	120		43,3	AC35425	4.500	Anhänger	8	V3-21-1	425/55R19,5 435/50R19,5
Jantsa	M22(Ø26)	281	335	10	0		39,4	141992	4.600	Anhänger	8	V3-12-1	445/45+65R19,5
22,5 x 7,50	M22(Ø24)	221	275	8	147	160	38	A15536*	3.150	Iveco	12	V3-22-1	255/70R22,5 265/70R22,5 275/80R22,5 275/90R22,5 10R22,5 11R22,5
	M22(Ø26)	281	335	10	152	165	35	AC15107*	3.750	div.	12	V3-22-1	
	M22(Ø26)	281	335	10	152	165	38	A16133*	3.350	div.	12	V3-22-1	
	M22(ØS36)	281	335	10	148	160	35,5	A16187*	3.350	Iveco, div.	12	V3-22-1	
	M22(Ø26)	281	335	10	148	160	35,5	AC15121*	3.350	Iveco, div.	12	V3-22-1	

*= mit auÙenliegendem Ventilloch

Felgenreiße	Radausföhrung (EUWA)	Mittenloch mm	Bolzenlochkreis mm	Bolzenlochzahl	Einpresstiefe mm	Halber Mittenabstand mm	Versandgewicht kg	Rad-Nr.	Radlast kg	Anwendung	Stück/Pal.	Ventilausföhrung	Reifengröße (empfohlen)
rim size	fixing type (EUWA)	hub diameter mm	bolt hole diameter mm	no. of bolt holes	offset mm	half dual spacing mm	weight kg	MWD art. no.	max. payload kg	customer	Qty. /pal.	valve type	tyre dimension (recommended)

Steilschulter-Räder für LKW und Anhänger (einteilig)

22,5 x 8,25	M22(Ø26)	281	335	10	152	165	37	A16094*	3.750	MAN, MB, Iveco	12	V3-22-1	265-275/70R22,5 275/80R22,5 285-295/60R22,5 295/80R22,5 305/70R22,5 11 - 12R22,5
	M22DS36	281	335	10	152	165	37	A16135*	3.750	MAN, MB, Iveco	12	V3-22-1	
	M22(Ø26)	281	335	10	157	170	37,5	A16118*	3.750	MAN, MB, Iveco	12	V3-22-1	
	M22DS36	281	335	10	157	170	37,5	A16188*	3.750	MAN, MB, Iveco	12	V3-22-1	
22,5 x 9,00	M22(Ø26)	281	335	10	162	175	38,4	AC15145*	4.000	MAN, MB, Iveco	12	V3-22-1	305/60/70R22,5 295/55/60R22,5 295/75/80R22,5 305/60/70R22,5 315/60/70R22,5 315/75/80R22,5 12 - 13R22,5
Accuride													
22,5 x 11,75	M22DS36	281	335	10	0		42	A15925*	4.500	Anhänger	12	V3-22-1	365/70R22,5 385/55R22,5 385/65R22,5
Jantsa	M22(Ø26)	281	335	10	0		39	117767*	5.000	Anhänger	12	V3-22-1	
Maxion	M22(Ø26)	281	335	10	120		41	2920839	5.000	MAN, MB, Iveco...	12	V3-22-1	
Accuride	M22(Ø26)	281	335	10	120		38,5	AC15146*	4.000	MAN, MB, Iveco	12	V3-22-1	
	M22(Ø26)	281	335	10	130		42	A16104*	5.000	Iveco, div.	12	V3-22-1	
	M22(Ø26)	281	335	10	135		42	A16099*	5.000	MB, Scania, div.	12	V3-22-1	
Jantsa	M22(Ø26)	281	335	10	135		46	117599*	5.000	div.	12		
22,5 x 13,00	M22(Ø26)	281	335	10	0		42	AC36403	5.150	Anhänger	8	V3-20-1	425+435/65R22,5
Accuride													
24 x 8,5 (5°-Steilschulterrad)	M22(Ø26)	281	335	10	161	175	53	A16090*	4.000	MAN, MB, Iveco	6, 12	V3-22-1	325/95R24 12.00R24

*= mit außenliegendem Ventilloch

Einteiliges LKW-Rad (15° Steilschulterrad)

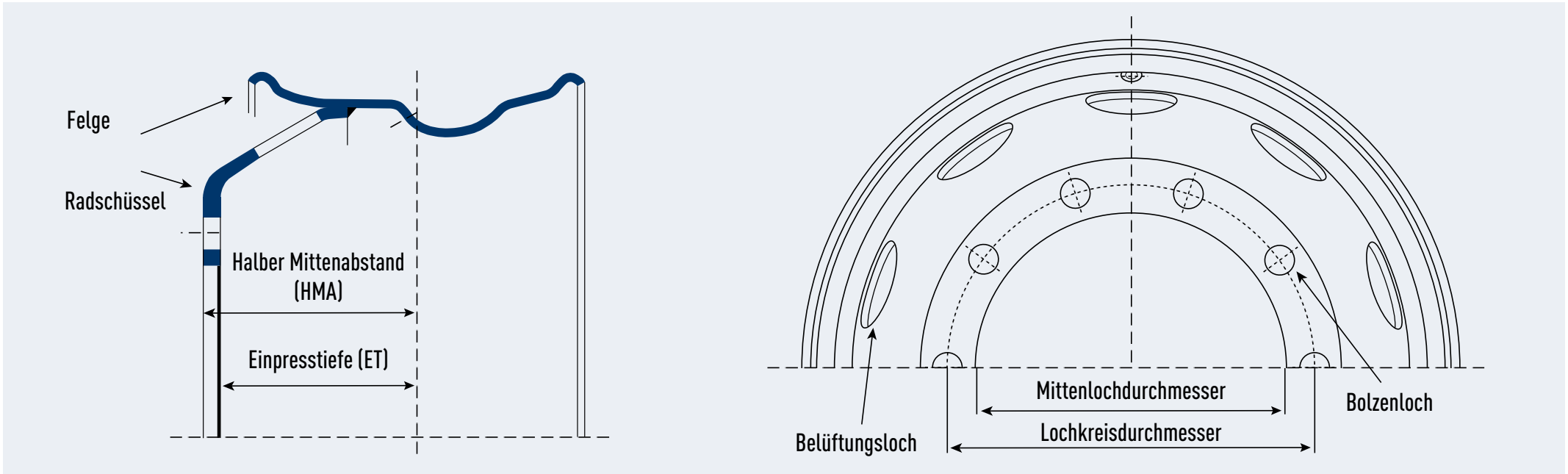

Bolzenloch-Ausführungen LKW-Räder

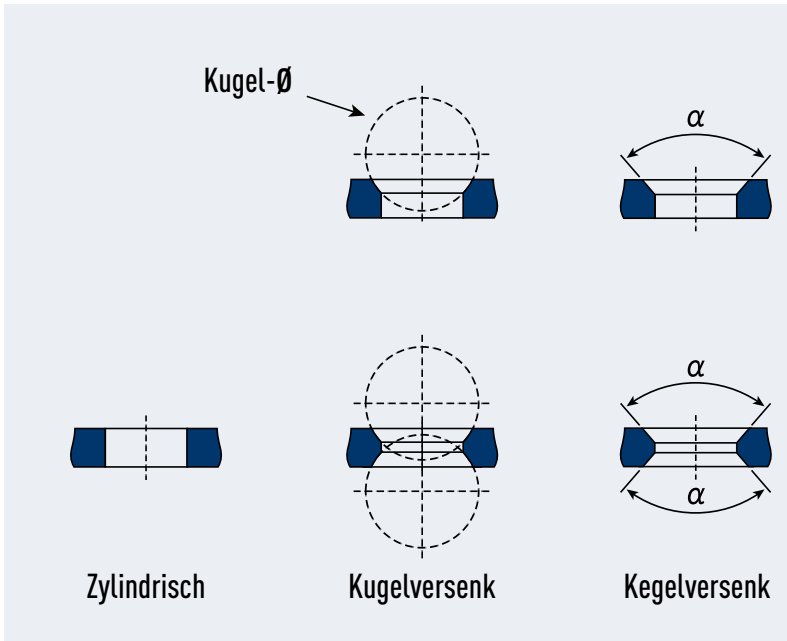

Bolzenlochbezeichnung nach EUWA

EUWA = Association of European wheel Manufacturers

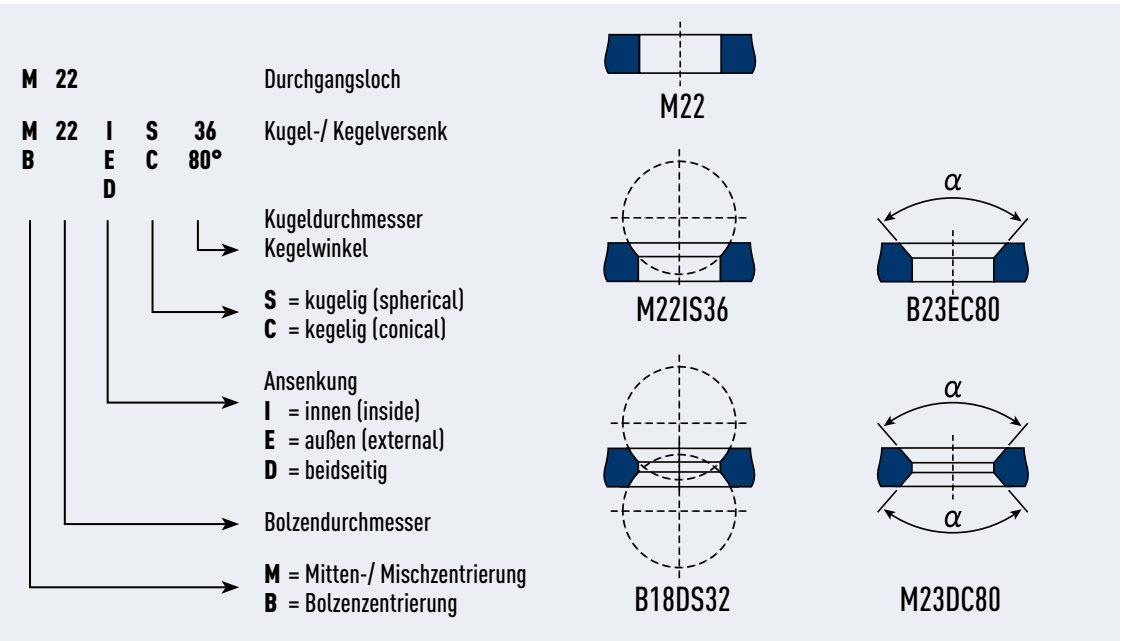

Bolzenlochansenkungen Bolzenlochformen und -Bezeichnungen Type of Stud hole Countersink gemäß EUWA - ES 3.15

Fixing Holes Seats Designation according to EUWA - ES 3.15

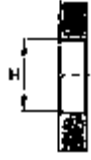
Zylindrische Bolzenlöcher Cylindrical Holes		Bezeichnung Designation	Bolzenloch-Durchmesser Holes diameter
		M 18	21
		M 20	24
		M 22	26

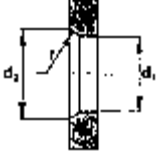
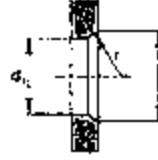
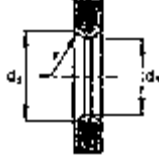
Kugelversenke Spherical Seats	Außenbefestigung External only	Innenbefestigung Internal only	Doppelseitig Double sided
			
	Code 1 B 18 ES 32	Code 1 B 18 IS 32	Code 1 B 18 DS 32
	Code 2 B 22 ES 36	Code 2 B 22 IS 36	Code 2 B 22 DS 36
	Code 33 M 22 ES 36	Code 33 M 22 IS 36	Code 33 M 22 DS 36
		Code 5 B 18 DS 44,4	

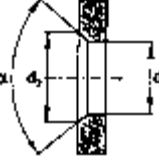
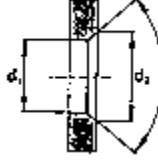
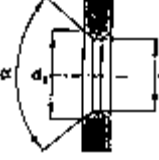
Kegelversenke Conical Seats	Außenbefestigung External only	Innenbefestigung Internal only	Doppelseitig Double sided
			
	Code 17 B 22 EC 80 Code 37 M 22 EC 80	Code 17 B 22 IC 80 Code 37 M 22 IC 80	Code 17 B 23 DC 80 Code 37 M 23 DC 80

Abmessungen und Eigenschaften Characteristics and Dimensions	Code	d1 +1/0	d2 ±0.5	r ±0,1	α ±1°
	1	21,5	27	16	-
	2	27	32	18	-
	33	26	32	18	-
	5	32,5	37,5	22,2	-
	17	25,4	31,5	-	80°
	37	26	31,5	-	80°

Bolzenlochansenkungen Bolzenlochformen und -Bezeichnungen Type of Stud hole Countersink gemäß EUWA - ES 3.15

Fixing Holes Seats Designation according to EUWA - ES 3.15

Tabelle für empfohlene Befestigung nach EUWA Standard ES-3.16 Table of recommended fixings (EUWA Standard ES-3.16)	Bolzenloch Zahl	Mittenloch	Lochkreis Durchm.	Planfläche min.	Loch Durchm.	Bolzen- Größe	Bolzenloch Code
	Holes No.	Pilot Hole	P.C.D.	Min. flat	Holes diam.	Bolt size	Holes code
	6	130	170	223	21	M 18 x 1,5	M 18
	6	161	205	255	21	M 18 x 1,5	M 18
	6	202	245	295	21	M 18 x 1,5	M 18
	8	221	275	325	24	M 20 x 1,5	M 20
	10	176	225	275	24	M 20 x 1,5	M 20
	10	281	335	390	26	M 22 x 1,5	M 22

alternative Befestigung Alternative, not of current use, fixings	Bolzenloch Zahl	Mittenloch	Lochkreis Durchm.	Planfläche min.	Loch Durchm.	Bolzen- Größe	Bolzenloch Code
	Holes No.	Pilot Hole	P.C.D.	Min. flat	Holes diam.	Bolt size	Holes code
	6	161	205	255	21,5	M 18 x 1,5	B18 DS32
	6	202	245	295	21,5	M 18 x 1,5	B18 DS32
	8	221	275	320	26	M 20 x 1,5	B22 DS36
	8	221	285	320	32,5	3/4"-16	B18 DS44
	10	221	285,7	350	32,5	3/4"-16	B18 DS44,4
	10	281	335	385	26	M 22 x 1,5	M22 DS36
	10	281	335	385	26	M 22 x 1,5	M22 DC80

Allgemeine Geschäftsbedingungen

I. Allgemeines, Geltungsbereich

- Unsere nachfolgenden Verkaufs- und Lieferbedingungen gelten ausschließlich und nur gegenüber Unternehmen, öffentlich-rechtlichen juristischen Personen sowie Sondervermögen im Sinne des § 310 BGB. Entgegenstehende oder von unseren Verkaufs- und Lieferbedingungen abweichende Bedingungen des Käufers erkennen wir nicht an, es sei denn, wir haben ausdrücklich schriftlich ihrer Geltung zugestimmt. Unsere Allgemeinen Verkaufs- und Lieferbindungen gelten auch dann, wenn wir in Kenntnis entgegenstehender oder abweichender Bedingungen des Käufers Beteiligungen an den Käufer vorbehaltlos ausführen. Selbst wenn wir auf ein Schreiben Bezug nehmen, das Geschäftsbedingungen des Käufers oder eines Dritten enthält oder auf solche verweist, liegt darin kein Einverständnis mit der Geltung jener Geschäftsbedingungen.
- Unsere Allgemeinen Verkaufs- und Lieferbedingungen gelten auch für alle künftigen Geschäfte mit dem Käufer und zwar ohne Rücksicht darauf, ob wir in jedem Einzelfall auf diese Bezug nehmen oder nicht.

II. Angebot, Vertragsschluss

- Alle Angebote unsererseits erfolgen freibleibend und unverbindlich, sofern sich aus der Auftragsbestätigung nichts anderes ergibt. Katalogdarstellungen sind unverbindlich.
- Bestellungen des Käufers gelten erst dann als angenommen, wenn wir sie schriftlich bestätigt haben. Wenn wir einen mündlich oder fernmündlich geschlossenen Vertrag nicht besonders schriftlich bestätigen, gilt die von uns erteilte Rechnung als Bestätigung.
- Alle Vereinbarungen, die zwischen uns und dem Käufer zur Ausführung eines Vertrages getroffen werden, sind in dem Vertrag und etwaigen Zusatzvereinbarungen schriftlich niederzulegen. Allein maßgeblich für die Rechtsbeziehungen zwischen uns und dem Käufer ist der schriftlich geschlossene Kaufvertrag, einschließlich etwaiger schriftlicher Zusatzvereinbarungen und dieser Allgemeinen Verkaufs- und Lieferbedingungen. Mündliche Zusagen die wir vor Abschluss dieses Vertrages treffen sind rechtlich unverbindlich und mündliche Abreden der Vertragsparteien werden durch den schriftlichen Vertrag ersetzt, sofern sich nicht jeweils ausdrücklich aus ihnen ergibt, dass sie verbindlich fortgelten.
- Ergänzungen und Abänderungen der getroffenen Vereinbarungen einschließlich dieser Allgemeinen Verkaufs- und Lieferbedingungen bedürfen zu ihrer Wirksamkeit der Schriftform. Zur Wahrung der Schriftform genügt die telekommunikative Übermittlung, insbes. per Telefax oder per E-Mail, sofern die Kopie der unterschriebenen Erklärung übermittelt wird.
- Unsere Angaben zum Gegenstand der Lieferung oder Leistung (zB Gewichte, Maße, Gebrauchswerte, Belastbarkeit, Toleranzen und technische Daten) sowie unsere Darstellungen desselben (zB Zeichnungen und Abbildungen) sind nur annähernd maßgeblich, soweit nicht die Verwendbarkeit zum vertraglich vorgesehenen Zweck eine genauere Übereinstimmung voraussetzt. Sie sind keine garantierten Beschaffenheitsmerkmale, sondern Beschreibungen oder Kennzeichnungen der Lieferung oder Leistung. Handelseübliche Abweichungen und Abweichungen, die aufgrund rechtlicher Vorschriften erfolgen oder technische Verbesserungen darstellen, sowie die Ersetzung von Bauteilen durch gleichwertige Teile sind zulässig, soweit sie die Verwendbarkeit zum vertraglich vorgesehenen Zweck nicht beeinträchtigen.
- Wir behalten uns das Eigentum oder Urheberrecht an allen von uns abgegebenen Angeboten und Kostenvoranschlägen sowie dem Auftraggeber zur Verfügung gestellten Zeichnungen, Abbildungen, Berechnungen, Prospekten, Katalogen, Modellen, Werkzeugen und anderen Unterlagen und Hilfsmitteln vor. Der Käufer darf diese Gegenstände ohne unsere ausdrückliche Zustimmung weder als solche noch inhaltlich Dritten zugänglich machen, sie bekannt geben, selbst oder durch Dritte nutzen oder vervielfältigen. Er hat auf unser Verlangen diese Gegenstände vollständig an uns zurückzugeben und eventuell gefertigte Kopien zu vernichten, wenn sie von ihm im ordnungsgemäßen Geschäftsgang nicht mehr benötigt werden oder wenn Verhandlungen nicht zum Abschluss eines Vertrages führen. Ausgenommen hiervon ist die Speicherung elektronisch zur Verfügung gestellter Daten zum Zwecke üblicher Datensicherung

III. Preise, Zahlungsbedingungen

- Sofern sich aus der Auftragsbestätigung nichts anderes ergibt, verstehen sich unsere Preise in Euro und „ab Werk“. Wir behalten uns das Recht vor, die Preise entsprechen zu erhöhen, wenn nach Abschluss des Vertrages Kostenerhöhungen, z. B. aufgrund von Tarifabschlüssen oder Material- oder Frachtpreissteigerungen, eintreten; gleiches gilt bei Kostenerhöhungen aufgrund für uns verbindlicher Regelungen nationalen, internationalen oder supra-nationalen Rechts bzw. deren Änderungen. Mehr- oder Sonderleistungen werden gesondert berechnet.
- Die Kosten für Verpackung, Verladung oder sonstige Nebenkosten sind im Preis nicht eingeschlossen und werden dem Käufer gesondert berechnet. Wir können verlangen, dass die Verpackung unter Erstattung der Nutzungsgebühren in gebrauchsfähigem Zustand frachtfrei an uns zurückgegeben wird.
- Die gesetzliche Mehrwertsteuer ist unseren Preisen nicht eingeschlossen. Sie wird in der gesetzlichen Höhe am Tag der Rechnungsstellung in der Rechnung gesondert ausgewiesen.
- Sofern sich aus der Auftragsbestätigung nichts anderes ergibt, ist der Rechnungsbetrag Zug um Zug gegen Lieferung, spätestens jedoch - falls die Lieferung noch nicht erfolgt sein sollte - innerhalb von 30 Tagen ab Rechnungsdatum ohne Abzug zur Zahlung fällig. Maßgebend für das Datum der Zahlung ist der Eingang beim Verkäufer.
- Bei Überschreitung des Zahlungsziels sind wir berechtigt, Zinsen in Höhe von 9 Prozentpunkten über dem Basiszins der Europäischen Zentralbank zu fordern. Falls wir in der Lage sind einen höheren Verzugszuschaden nachzuweisen, sind wir berechtigt, diesen geltend zu machen. Der Käufer ist berechtigt, uns nachzuweisen, dass als Folge des Zahlungsverkehrs kein oder ein geringerer Schaden entstanden ist.
- Aufrechnungs- oder Zurückbehaltungsrecht stehen dem Käufer nur zu, wenn seine Gegenansprüche rechtskräftig festgestellt, unbestritten sind und von uns anerkannt sind.
- Wir behalten uns die Annahme von Wechseln bzw. Schecks ausdrücklich vor. Nehmen wir Wechsel bzw. Schecks an, wird die Schuld erst durch deren Erlösung getilgt. Diskontspesen sowie mit der Einziehung der Wechsel- bzw. Scheckbeträge im Zusammenhang stehenden Kosten trägt der Käufer.
- Wenn bei dem Käufer kein ordnungsgemäßer Geschäftsbetrieb mehr gegeben ist, insbesondere bei ihm geplündert wird oder Zahlungsstockung oder gar Zahlungseinstellung eintritt oder von ihm ein oder die Eröffnung eines Insolvenzverfahrens beantragt wird, sind wir berechtigt, alle unsere Forderungen aus der Geschäftsverbindung sofort fällig zu stellen, auch wenn wir Wechsel oder Schecks angenommen haben. Dasselbe gilt, wenn der Käufer mit seinen Zahlungen an uns in Verzug gerät oder anderer Umstände bekannt werden, die seine Kreditwürdigkeit zweifelhaft erscheinen lassen. Außerdem sind wir in einem solchen Fall berechtigt, Vorauszahlungen oder Sicherheitsleistung zu verlangen oder vom Vertrag zurück zu treten.
- Wir sind berechtigt, noch ausstehende Lieferungen oder Leistungen nur gegen Vorauszahlung oder Sicherheitsleistung auszuführen oder zu erbringen, ein uns nach Abschluss des Vertrages Umstände bekannt werden, welche die Kreditwürdigkeit des Käufers wesentlich zu mindern geeignet sind und durch welche die Bezahlung unserer offenen Forderungen durch den Käufer aus dem jeweiligen Vertragsverhältnis (einschließlich aus anderen Einzelfallurteilen, für die derselbe Rahmenvertrag gilt) gefährdet wird.
- Der Käufer darf Ansprüche aus mit uns geschlossenen Rechtsgeschäften nur mit unserer ausdrücklichen Zustimmung abtreten.

IV. Lieferung- und Leistungszeit, Verzug

- Von uns in Aussicht gestellte Fristen und Termine für Lieferungen und Leistungen gelten stets nur annähernd, es sei denn, dass ausdrücklich eine feste Frist oder ein fester Termin zugesagt oder vereinbart ist. Alle Fristen und Termine gelten vorbehaltlich rechtzeitiger und vollständiger Selbstbelieferung.
- Wird eine Lieferfrist vereinbart, ist die Frist eingehalten, wenn der Liefergegenstand bis Fristablauf das Werk verlassen hat oder die Versandbereitschaft mitgeteilt ist.
- Wir sind nur zu Teillieferungen berechtigt, wenn die Teillieferung für den Käufer im Rahmen des vertraglichen Bestimmungszwecks verwendbar ist, die Lieferung der restlichen Bestelle Ware sichergestellt ist und dem Käufer hierdurch kein erheblicher Mehraufwand oder zusätzliche Kosten entstehen (es sei denn, wir erklären uns zur Übernahme dieser Kosten bereit).
- Wir haften nicht für Unmöglichkeit der Lieferung oder für Lieferverzögerungen, soweit diese durch höhere Gewalt oder sonstige, zum Zeitpunkt des Vertragsabschlusses nicht vorhersehbare Ereignisse (zB Betriebsstörungen aller Art, Schwierigkeiten in der Material- oder Energiebeschaffung, Transportverzögerungen, Ein- und Ausfuhrverbote, Streiks, rechtmäßige Aussparungen, Mangel an Arbeitskräften, Energie oder Rohstoffen, Schwierigkeiten bei der Beschaffung von notwendigen behördlichen Genehmigungen, welche die behördliche Maßnahmen oder die ausbleibende, nicht richtige oder nicht rechtzeitige Belieferung durch Lieferanten) verursacht worden sind, die wir nicht zu vertreten haben. Sofern solche Ereignisse uns die Lieferung oder Leistung wesentlich erschweren oder unmöglich machen und die Behinderung nicht nur von vorübergehender Dauer ist, sind wir zum Rücktritt vom Vertrag berechtigt. Bei Hindernissen vorübergehender Dauer verlangen sich die Liefer- oder Leistungsfristen oder verschieben sich die Liefer- oder Leistungstermine um den

Zeitraum der Behinderung zzgl. einer angemessenen Anlauffrist. Dauert die Behinderung länger als zwei Monate, so ist der Käufer nach Setzung einer angemessenen Nachfrist berechtigt, sich vom Vertrag zu lösen, wenn er nachweist, dass die völlig oder teilweise ausstehende Erfüllung des Vertrages wegen der Verzögerung für ihn kein Interesse mehr hat.

- Setzt der Käufer uns, wenn wir bereits in Verzug geraten sind, eine angemessene Nachfrist mit Ablehnungsandrohung, so ist er nach fristlosem Ablauf dieser Nachfrist berechtigt, sich vom Vertrag zu lösen. Schadensersatzansprüche gegen uns infolge Verzugs richten sich nach VIII.
- Die Einhaltung der Liefer- und Leistungsverpflichtung durch uns setzt die rechtzeitige und ordnungsgemäße Erfüllung aller Vertragspflichten durch den Käufer voraus. Wir können – unbeschadet unserer Rechte aus Verzug des Käufers – vom Käufer eine Verlängerung von Liefer- und Leistungsfristen oder eine Verschiebung von Liefer- und Leistungsterminen um den Zeitraum verlangen, in dem der Käufer seinen vertraglichen Verpflichtungen uns gegenüber nicht nachkommt.
- Kommt der Käufer in Annahmeverzug, verzögert sich der Versand durch vom Käufer zu tretende Umstände oder verletzt der Käufer sonstige Mitwirkungspflichten, so sind wir berechtigt, den entstandenen Schaden einschließlich etwaiger Mehraufwendungen (z. B. Lagerkosten) ersetzt zu verlangen und bei Versandverzögerung den Liefergegenstand auf Kosten und Gefahr des Käufers nach unserem Ermessen zu lagern. In diesem Fall geht auch die Gefahr eines zufälligen Untergangs oder einer zufälligen Verschlechterung der Kaufsache in dem Zeitpunkt auf den Käufer über, in dem dieser in Annahmeverzug gerät.
- Lassen wir Teile nach vom Käufer übergebenen Zeichnungen, Mustern etc. herstellen, und liefern wir diese Teile, übernehmen wir keine Gewähr dafür, dass Schutzrechte Dritter verletzt werden. Wird uns unter Berufung auf Schutzrechte Dritter die Beschaffung und Lieferung untersagt, sind wir berechtigt, die Tätigkeit sofort einzustellen und Ersatz der bisher angefallenen Kosten zu verlangen. Der Käufer verpflichtet sich, uns von allen damit im Zusammenhang stehenden Ansprüchen Dritter freizustellen.
- Bei Änderungen an Konstruktion und Ausführungen, die der Hersteller der Ware vor Auslieferung eines Auftrages an den betreffenden Liefergegenstand ganz allgemein vorgenommen hat und die den Gebrauchswert des Liefergegenstandes in keiner Weise einschränken, kann eine Beanstandung nicht erfolgen bzw. bestehen keine Entschädigungsansprüche. Die vorbezeichneten Umstände sind auch dann nicht von uns zu vertreten, wenn sie während eines bereits vorhandenen Lieferverzugs eintreten.
- Geraten wir mit einer Lieferung oder Leistung in Verzug oder wird uns eine Lieferung oder Leistung, gleich aus welchem Grund, unmöglich, so ist unsere Haftung auf Schadensersatz nach Maßgabe des VII. dieser Allgemeinen Verkaufs- Lieferbedingungen beschränkt.

V. Erfüllungsort, Versand, Verpackung, Gefahrübergang, Transportversicherung, Abnahme

- Alle Lieferungen erfolgen ab Werk und gehen auf Rechnung. Erfüllungsort für alle Verpflichtungen aus dem Vertragsverhältnis ist unser Unternehmenssitz in Schorndorf, soweit nichts anderes bestimmt ist. Schulden wir auch die Installation, ist Erfüllungsort der Ort, an dem die Installation zu erfolgen hat.
- Die Gefahr geht spätestens mit der Übergabe des Liefergegenstandes (wobei der Beginn des Verladevorgangs maßgeblich ist) an den Spediteur, Frachtführer oder sonst zur Ausführung der Versendung bestimmten Dritten auf den Käufer über. Dies gilt auch dann, wenn Teillieferungen erfolgen oder wir noch andere Leistungen (zB Versand oder Installation) übernommen haben. Verzögert sich der Versand oder die Übergabe infolge eines Umstandes, dessen Ursache beim Käufer liegt, geht die Gefahr von dem Tag an auf den Käufer über, an dem der Liefergegenstand versandbereit ist und wir dies dem Käufer angezeigt haben.
- Die Versandart, Transportmittel, Transportwege und die Verpackung unterstehen mangels besonderer Weisung des Kunden unserem pflichtgemäßen Ermessen.
- Eine Transportversicherung wird von uns nur auf ausdrücklichen Wunsch des Kunden und auf dessen Kosten abgeschlossen. Transportschäden sind und sowie dem anliefernden Spediteur unverzüglich anzuzeigen.
- Lagerkosten nach Gefahrübergang trägt der Käufer. Bei Lagerung durch uns betragen die Lagerkosten (0,2%) des Rechnungsbetrages der zu lagernden Liefergegenstände pro abgelaufene Woche. Die Geltendmachung und der Nachweis weiterer oder geringerer Lagerkosten bleiben vorbehalten.

VI. Mängelansprüche des Käufers

- Die gelieferten Gegenstände sind unverzüglich nach Ablieferung an den Käufer oder an den von ihm bestimmten Dritten sorgfältig zu untersuchen. Sie gelten hinsichtlich offensichtlicher Mängel oder anderer Mängel, die bei einer unverzüglichen, sorgfälligen Untersuchung erkennbar gewesen wären, als vom Käufer genehmigt, wenn uns nicht unverzüglich nach Eingang der gelieferten Gegenstände beim Käufer eine schriftliche Mängelrüge zugeht. Hinsichtlich anderer Mängel gelten die Liefergegenstände als vom Käufer genehmigt, wenn die Mängelrüge dem Verkäufer nicht binnen (sieben) Werktagen nach dem Zeitpunkt zugeht, in dem sich der Mangel zeigte, war der Mangel bei normaler Verwendung bereits zu einem früheren Zeitpunkt offensichtlich, ist jedoch dieser frühere Zeitpunkt für den Beginn der Rügefrist maßgeblich. Auf Verlangen des Verkäufers ist ein beanstandeter Liefergegenstand frachtfrei an den Verkäufer zurückzusenden. Bei berechtigter Mängelrüge vergütet der Verkäufer die Kosten des günstigsten Versandweges; dies gilt nicht, soweit die Kosten sich erhöhen, weil der Liefergegenstand sich an einem anderen Ort als dem Ort des bestimmungsgemäßen Gebrauchs befindet.
- Bei von uns zu vertretenden Sachmängeln der gelieferten Gegenstände sind wir nach unserer innerhalb angemessener Frist zu treffenden Wahl zunächst zur Nachbesserung oder Ersatzlieferung verpflichtet und berechtigt. Im Falle des Fehlschlagens, d. h. der Unmöglichkeit, Unzumutbarkeit, Verweigerung oder unangemessenen Verzögerung der Nachbesserung oder Ersatzlieferung, kann der Auftraggeber vom Vertrag zurücktreten oder den Kaufpreis angemessen mindern.
- Normale Abnutzung fällt nicht unter die Gewährleistung. Gleiches gilt für Schäden infolge unsachgemäßer Behandlung, z. B. durch Überlastung über die durch das Deutsche Institut für Normung festgesetzte Tragfähigkeit hinaus oder bei Verwendung nicht der einschlägigen DIN-Norm entsprechender Reifen sowie für Schäden, die durch unsachgemäße Verwendung, unsachgemäße Pflege oder unsachgemäße Wartung entstanden sind.
- Beruhet ein Mangel auf unserem Verschulden, kann der Käufer unter den in VIII. bestimmten Voraussetzungen Schadensersatz verlangen.
- Die Gewährleistung entfällt, wenn der Käufer ohne unsere Zustimmung den Liefergegenstand ändert oder durch Dritte andern Umständen und die Mängelbeseitigung hierdurch unmöglich oder unzumutbar erschwert wird. In jedem Fall hat der Käufer die durch die Änderung entstehenden Mehrkosten der Mängelbeseitigung zu tragen.
- Bei Mängeln von Bauteilen anderer Hersteller, die wir aus lizenzrechtlichen oder tatsächlichen Gründen nicht beseitigen können, werden wir nach unserer Wahl unsere Gewährleistungsansprüche gegen die Hersteller und Lieferanten für Rechnung des Käufers geltend machen oder an den Käufer abtreten. Gewährleistungsansprüche gegen uns bestehen bei derartigen Mängeln unter den sonstigen Voraussetzungen und nach Maßgabe dieser Allgemeinen Verkaufs- Lieferbedingungen nur, wenn die gerichtliche Durchsetzung der vorstehend genannten Ansprüche gegen den Hersteller und Lieferanten erfolglos war oder, bspw. aufgrund einer Insolvenz, aussichtslos ist. Während der Dauer des Rechtsstreits ist die Verjähung der betreffenden Gewährleistungsansprüche des Käufers gegen uns gehemmt.
- Die Gewährleistungsfrist beträgt ein Jahr ab Lieferung oder, soweit eine Abnahme erforderlich ist, ab der Abnahme. Diese Frist gilt nicht für Schadensersatzansprüche des Käufers aus der Verletzung des Lebens, des Körpers oder der Gesundheit oder aus vorsätzlichen oder grob fahrlässigen Pflichtverletzungen durch uns oder unsere Erfüllungsgehilfen, welche jeweils nach den gesetzlichen Vorschriften präferieren.
- Eine im Einzelfall mit dem Käufer vereinbarte Lieferung gebrauchter Gegenstände erfolgt unter Ausschluss jeglicher Gewährleistung für Sachmängel.

VII. Eigentumsvorbehalt

- Die von uns gelieferte Ware bleibt unser Eigentum, bis der Käufer sämtliche Forderungen aus der Geschäftsverbindung – auch Saldoforderungen aus Kontokorrent sowie aus Refinanzierungs- oder Umkehrwechseln – begleichen hat.
- Der Käufer ist berechtigt, die von uns gelieferte Ware im ordnungsgemäßen Geschäftsgang zu veräußern. Die hiernach eingeräumte Berechtigung erlischt insbesondere in den vorstehend in III. 8. genannten Fällen. Darüber hinaus sind wir berechtigt, die Veräußerungsbefugnisse des Käufers durch schriftliche Erklärung zu widerrufen, wenn er mit der Erfüllung seiner Verpflichtungen uns gegenüber und insbesondere mit seinen Zahlungen in Verzug gerät oder sonstige Umstände bekannt werden, die seine Kreditwürdigkeit zweifelhaft erscheinen lassen.
- Für das Recht des Käufers, die von uns gelieferte Ware zu verarbeiten, gelten die Beschränkungen des vorstehenden Abs. 2 entsprechend. Durch die Verarbeitung erwirbt der Käufer kein Eigentum an den ganz oder teilweise hergestellten Sachen; die Verarbeitung erfolgt unentgeltlich ausschließlich für uns als Hersteller im Sinne von § 950 BGB. Sollte unser Eigentumsvorbehalt dennoch durch irgendwelche Umstände Erlöschen, so sind der Käufer und wir uns schon jetzt darüber einig, dass das Eigentum an den Sachen mit der Verarbeitung auf uns übergeht, wir die Übereignung annehmen und der Käufer unentgeltlicher Verwahrer der Sachen bleibt.

- Wird unsere Vorbehaltsware mit noch im Fremdeigentum stehenden Waren verarbeitet oder untrennbar vermischt, erwerben wir Miteigentum an den neuen Sachen oder vermischten Bestand. Der Umfang des Miteigentums ergibt sich aus dem Verhältnis des Rechnungswertes der von uns gelieferten Vorbehaltsware zum Rechnungswert der übrigen Ware.
- Waren, an denen wir gem. der vorstehenden Abs. 3 und 4 Eigentum oder Miteigentum erwerben, gelten, ebenso wie die uns gem. vorstehendem Abs. 1 unter Eigentumsvorbehalt gelieferte Ware, als Vorbehaltsware im Sinne der nachfolgenden Bestimmungen.
- Der Käufer tritt bereits jetzt die Forderungen aus einem Weiterverkauf der Vorbehaltsware an uns ab. Zu den Forderungen aus einem Weiterverkauf zählt auch die Forderung gegen die Bank, die im Rahmen des Weiterverkaufs ein Akkreditiv zugunsten des Käufers (= Weiterverkäufers) eröffnet hat oder bestätigt. Wir nehmen diese Abtretung hiermit an. Handelt es sich bei der Vorbehaltsware um ein Verarbeitungsprodukt oder um einen vermischten Bestand, worin neben von uns gelieferter Ware nur solche Gegenstände enthalten sind, die entweder dem Käufer gehörten oder aber ihm von Dritten nur unter dem so genannten einfachen Eigentumsvorbehalt geliefert worden sind, so tritt der Käufer die gesamte Forderung aus Weiterveräußerung der Ware an uns ab. Im anderen Falle, also bei einem Zusammentreffen von Voraussessionen an uns und andere Lieferanten steht uns an andere Lieferanten ein Bruchteil des Veräußerungserlöses zu, und zwar entsprechend dem Verhältnis des Rechnungswertes unsere Ware zum Rechnungswert der anderen verarbeiteten oder vermischten Ware.
- Soweit unsere Forderungen insgesamt durch die vorstehend erklärten Abtretungen bzw. Vorbehalte zu mehr als 125 % zweifelsfrei besichert sind, wird der Überschuss der Außenstände bzw. der Vorbehaltsware auf Verlangen des Käufers nach unserer Auswahl freigegeben.
- Der Käufer ist ermächtigt, die Außenstände aus Weiterveräußerung der Ware einzuziehen. Diese Einzugsermächtigung entfällt, wenn bei dem Käufer im Sinne der Regelung in III. 8. kein ordnungsgemäßer Geschäftsgang mehr gegeben ist. Darüber hinaus können wir die Einzugsermächtigung des Käufers widerrufen, wenn er mit der Erfüllung seiner Pflichten uns gegenüber; insbesondere mit seinen Zahlungen in Verzug gerät oder sonstige Umstände bekannt werden, die seine Kreditwürdigkeit zweifelhaft erscheinen lassen. Entfällt die Einzugsermächtigung oder wird sie von uns widerrufen, hat uns der Käufer auf unser Verlangen unverzüglich die Schuldner der abgetretenen Forderungen mitzuteilen und uns die zur Einziehung erforderlichen Auskünfte und Unterlagen zu geben.
- Bei Zugriffen Dritter auf unsere Vorbehaltsware oder die uns abgetretenen Außenstände ist der Käufer verpflichtet, auf unser Eigentum/unsere Recht hinzuweisen und uns unverzüglich zu benachrichtigen. Die Kosten einer Intervention trägt der Käufer.
- Bei vertragswidrigem Verhalten des Käufers, insbesondere bei Zahlungsverzug, ist der Käufer verpflichtet, auf unser erstes Anfordern, die bei ihm noch befindliche Vorbehaltsware herauszugeben und etwaige, gegen Dritte bestehende Herausgabensprüche wegen der Vorbehaltsware an uns abzutreten. In der Zurücknahme sowie der Pfändung von Vorbehaltsware durch uns liegt kein Rücktritt vom Vertrag
- Wir können in den Fällen der II. 8. vom Käufer verlangen, dass er uns die durch Weiterveräußerung entstehenden und gem. VII. (6) an uns abgetretenen Forderungen und deren Schuldner bekannt gibt. Sodann sind wir berechtigt, die Abtretung nach unserer Wahl offenzulegen.

VIII. Haftung auf Schadensersatz wegen Verschuldens

- Die Haftung des Verkäufers auf Schadensersatz, gleich aus welchem Rechtsgrund, insbes. aus Unmöglichkeit, Verzug, mangelhafter oder falscher Lieferung, Vertragsverletzung, Verletzung von Pflichten bei Vertragsverhandlungen und unerlaubter Handlung ist, soweit es dabei jeweils auf ein Verschulden ankommt, nach Maßgabe dieses VIII. eingeschränkt.
- Der Verkäufer haftet vorbehaltlich gesetzlicher Haftungsbeschränkungen nicht im Falle einfacher Fahrlässigkeit seiner Organe, gesetzlichen Vertreter, Angestellten oder sonstigen Erfüllungsgehilfen, soweit es sich nicht um eine Verletzung vertragswesentlicher Pflichten handelt. Vertragswesentlich sind die Verpflichtung zur rechtzeitigen Lieferung und Installation des Liefergegenstands, dessen Freiheit von Rechtsmängeln sowie solchen Sachmängeln, die seine Funktionstüchtigkeit oder Gebrauchstauglichkeit mehr als nur unerheblich beeinträchtigen, sowie Beratungs-, Schutz- und Obtuschpflichten, die dem Auftraggeber die vertragsgemäße Verwendung des Liefergegenstands ermöglichen sollen oder den Schutz von Leib oder Leben von Personal des Auftraggebers oder den Schutz von dessen Eigentum vor erheblichen Schäden bewecken.
- Soweit der Verkäufer gem. Abs. 2 dem Grunde nach auf Schadensersatz haftet, ist diese Haftung auf Schäden begrenzt, die der Verkäufer bei Vertragsschluss als mögliche Folge einer Vertragsverletzung vorausgesehen hat oder die er bei Anwendung verkehrsbüher Sorgfalt hätte voraussehen müssen. Mittlere Schäden und Folgeschäden, die Folge von Mängeln des Liefergegenstands sind, sind außerdem nur ersatzfähig, soweit solche Schäden bei bestimmungsgemäßer Verwendung des Liefergegenstands typischerweise zu erwarten sind.
- Die vorstehenden Haftungsausschlüsse und -beschränkungen gelten in gleichem Umfang zugunsten der Organe, gesetzlichen Vertreter, Angestellten und sonstigen Erfüllungsgehilfen des Verkäufers.
- Soweit der Verkäufer technische Auskünfte gibt oder beratend tätig wird und diese Auskünfte oder Beratung nicht zu dem von ihm geschuldeten, vertraglich vereinbarten Leistungsumfang gehören, geschieht dies unentgeltlich und unter Ausschluss jeglicher Haftung.
- Die Einschränkungen dieses VIII. gelten nicht für die Haftung des Verkäufers wegen vorsätzlichen Verhaltens, für garantierte Beschaffenheitsmerkmale, wegen Verletzung des Lebens, des Körpers oder der Gesundheit oder nach dem Produkthaftungsgesetz.

IX. Datenverarbeitung

Wir sind berechtigt, die im Zusammenhang mit der Geschäftsverbindung erhaltenen Daten über den Besteller im Sinne des Bundesdatenschutzgesetzes für unsere geschäftlichen Zwecke zu verwenden. Wir haben Daten über den Käufer nach dem Datenschutzbestimmungen gespeichert. Die Erklärungen zur Datensicherungsverordnung finden sich auf unserer Website.

X. Sonderbedingungen

Alle als Muster eingesandten sowie durch Instandsetzung oder Umänderung unbrauchbar gewordenen oder durch neu ersetzte Teile werden verschrottet, sofern die Rücklieferung bei Bestellung nicht vorgeschrieben ist. Die Verschrottungskosten sowie weitere in diesem Zusammenhang anfallenden Kosten gehen zu Lasten des Käufers.

XI. Anzuwendendes Recht

Es gilt ausschließlich das Recht der Bundesrepublik Deutschland. Internationales Kaufrecht ist ausgeschlossen. Das gilt ausdrücklich auch für die Anwendung des Übereinkommens der Vereinten Nationen über Verträge über den internationalen Warenkauf (CISG).

XII. Sonstige Bestimmungen

- Soweit der Vertrag oder diese Allgemeinen Verkaufs- oder Lieferbedingungen Regelungslücken enthalten, gelten zur Ausfüllung dieser Lücken diejenigen rechtlich wirksamen Regelungen als vereinbart, welche die Vertragspartner nach den wirtschaftlichen Zielsetzungen des Vertrages und dem Zweck dieser Allgemeinen Verkaufs- und Lieferbedingungen vereinbart hätten, wenn sie die Regelungslücke gekannt hätten.
- Ausschließlicher Gerichtsstand für alle Streitigkeiten ist unser Geschäftssitz in Schorndorf. Ist der Käufer Kaufmann, eine juristische Person des öffentlichen Rechts oder ein öffentlich-rechtliches Sondervermögen oder hat er in der Bundesrepublik Deutschland keinen allgemeinen Gerichtsstand, so ist Gerichtsstand für alle etwaigen Streitigkeiten aus der Geschäftsbeziehung zwischen uns und dem Käufer unser Geschäftssitz in Schorndorf. Wir sind jedoch in allen Fällen auch berechtigt, Klage am Erfüllungsort der Lieferverpflichtung gemäß diesen Allgemeinen Verkaufs- und Lieferbedingungen bzw. einer vorrangigen Individualabrede oder am allgemeinen Gerichtsstand des Käufers zu erheben. Zwingende gesetzliche Bestimmungen über ausschließliche Gerichtsstände bleiben von dieser Regelung unberührt.

Stand: Juni 2023

MW





MW Deutschland GmbH

